

THINKWARETM DASH CAM

X500

User Manual



This Dashboard Camera (dash cam) is a specialized onboard device that continuously records video while the vehicle is in use.

Some features may not be available depending on installation, driving conditions, and vehicle type. The video quality might vary for each device as a result of installed firmware.

The device DOES NOT guarantee video recording of all accidents as built-in impact sensor may not be activated due to combination of user settings and the level of impact during the collision.

Contents

	Before Using THINKWARE DASH CAM™ X500	2
	FCC Statement	2
	Caution	3
01	Getting Started	
	1-1. In the Package	4
	1-2. Optional Accessories	4
	1-3. Product Overview	5
	1-4. Inserting a Memory Card	6
	1-5. Vehicle Installation	7
02	Basic Operations	
	2-1. Turning the Device Power On/Off	9
	2-2. Road Safety Warning	10
	2-3. Recorded Files	13
	2-4. Recording Videos While Driving	14
	2-5. Recording Videos While Parked (Optional Accessory)	16
	2-6. Manual Recording	17
	2-7. Formatting MicroSD Card	18
	2-8. Upgrading Firmware	18
03	LCD Screen	
	3-1. Main Menu	19
	3-2. Live View	20
	3-3. File List	21
	3-4. Memory Card Settings	23
	3-5. Dual Save Videos	24
	3-6. Settings > Camera Settings	25
	3-7. Settings > Record settings	26
	3-8. Settings > Road Safety settings	27
	3-9. Settings > System Settings	28
	3-10. About Device	29
04	PC Viewer Software	
	4-1. Thinkware Dash Cam PC Viewer	30
05	Device Information	
	5-1. Specifications	35

Before Using THINKWARE DASH CAM™ X500

- ▶ Under the copyright laws, this manual may not be copied, in whole or in part, without the written consent of THINKWARE.
- ▶ Every effort has been made to ensure this Guide's accuracy. However, we cannot guarantee the accuracy of the contents in this document as there may be technical errors, omissions, and/or future changes.
- ▶ THINKWARE reserves the right to change or modify the product and the content of this manual at any time without prior notice for product improvements.
- ▶ Images contained in this user guide are illustrations for instructional purposes only and may differ from the actual product.
- ▶ Users do not reserve the right to use the product for purposes other than as specified in this user guide. According to the Personal Information Protection Act and other related regulations, the user/owner may be held liable if the video and/or conversation recorded by the device are distributed without their consent. Thus, special attention should be paid in using this product.

- The MicroSD memory card should be tested for errors on a regular basis and as the memory card is a consumable item, it will need to be replaced periodically.
- THINKWARE shall NOT be responsible for any problems and/or damages that may occur from the use of disingenuous, modified, or unauthorized parts and accessories.
- The device and the recorded videos are intended for personal use and the recorded videos should be used for reference only.
- The device does NOT guarantee video recording of all accidents as built-in impact sensor may not be activated due to combination of user settings and the level of impact during the collision.

FCC Statement

This device complies with Part 15 of the FCC Rules. Operation is subject to the following two conditions: (1) this device may not cause harmful interference, and (2) this device must accept any interference received, including interference that may cause undesired operation.

This equipment has been tested and found to comply with the limits for a Class B digital device, pursuant to Part 15 of the FCC Rules. These limits are designed to provide reasonable protection against harmful interference in a residential installation. This equipment generates, uses and can radiate radio frequency energy and, if not installed and used in accordance with the instructions, may cause harmful interference to radio communications. However, there is no guarantee that interference will not occur in a particular installation. If this equipment does cause harmful interference to radio or television reception, which can be determined by turning the equipment off and on, the user is encouraged to try to correct the interference by one or more of the following measures:

- ▶ Reorient or relocate the receiving antenna.
- ▶ Increase the separation between the equipment and receiver.
- ▶ Connect the equipment into an outlet on a circuit different from that to which the receiver is connected.
- ▶ Consult the dealer or an experienced radio/TV technician for help.

FCC CAUTION: Any changes or modifications to the equipment not expressly approved by the party responsible for compliance could void your authority to operate the equipment.

This Class A digital apparatus complies with Canadian ICES-003.

Caution

- ◆ Depending on the make and model of your car, the power may be constantly supplied to the dash cam even with the ignition turned off. This may result in vehicle battery discharge.
- ◆ This device is designed to record video while the vehicle is in operation. The quality of the video might be affected by weather conditions and the road environment such as day or night, presence of street lighting, entering/exiting tunnels, and the surrounding temperature.
- ◆ THINKWARE is NOT responsible for the loss of any recorded video during operation.
- ◆ Although designed to withstand high impact of car collision, THINKWARE does NOT guarantee recording of accidents where the impact may cause the device to be damaged.
- ◆ Keep the windshield clean for optimal video quality.
- ◆ If a foreign substance (e.g. fingerprints) is attached to the lens, it may reduce the quality of the recorded videos. Keep the lens clean all the time.
- ◆ The specified operating temperature of this product is -10°C to 60°C (14°F to 140°F) and storage temperature is -20°C to 70°C (-4°F to 158°F). Ensure that the device is kept within these temperature ranges; otherwise, the device may not function as designed and at extreme temperatures, permanent physical damage can result which is not covered by warranty.
- ◆ Avoid placing the device under direct sunlight.
- ◆ Avoid using the device in extreme conditions where the Product is exposed to high temperature and/or humidity.
- ◆ Only use genuine accessories and peripherals from THINKWARE or authorized THINKWARE dealer. THINKWARE does not warrant the safety and compatibility from use of peripherals from other manufacturers. Use genuine parts supplied by THINKWARE.
- ◆ Do not apply excessive force when pushing the buttons on the device.
- ◆ Do not clean the Product using chemical cleaner or solvents as it may damage plastic components. Use soft, clean, dry fabric to gently wipe the Product.
- ◆ Do not place or store the device where it can be accessible by children and pets.
- ◆ Do not disassemble the Product as it will void product warranty and may also damage the product.
- ◆ Handle with care. Drop, shock, and mishandling the Product may result in malfunction and/or damage to the device.
- ◆ Do not operate this device while driving.
- ◆ Install this device in a location where it has unobstructed view of the road but does not interfere with the driver's view. Check with your local and regional laws before mounting to windshield.
- ◆ The device and/or installation parts have moving parts and may shift in extreme road conditions such as unpaved road. Check frequently to ensure the device is positioned as instructed in this guide.
- ◆ Do not operate or handle power cable with wet hands.
- ◆ Do not use a damaged power cable.
- ◆ Keep the power cable away from heaters or other hot objects.
- ◆ Check that power cable with correct connector is used and the connections are secure and firmly in place.
- ◆ Do not pull, insert, or bend the power cable using excessive force.
- ◆ Do not place heavy objects on the device and the power cable.
- ◆ Do not modify or cut the power cable.
- ◆ THINKWARE does not guarantee that devices or peripherals not authorized by THINKWARE will be compatible with its Product.
- ◆ Do not attempt to insert foreign objects into the device or power cable.
- ◆ Do not spill or spray liquid into the device as it may cause malfunction, fire, or electric shock.
- ◆ This device is intended to be used inside the vehicle only.

1. Getting Started

This unit was tested with shielded cables on the peripheral devices. Shielded cables must be used with the unit to ensure compliance.

1-1. In the Package



Main Dash Cam Unit



Mount with 3M tape
(1ea)



Car Charger



Adhesive Cable Holder
(5ea)

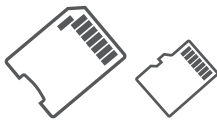

MicroSD memory card with adapter
(consumable)



USB MicroSD card
reader



Quick Start Guide/Warranty/
User Manual (stored in the MicroSD card)

1-2. Optional Accessories





Hardwiring Cable

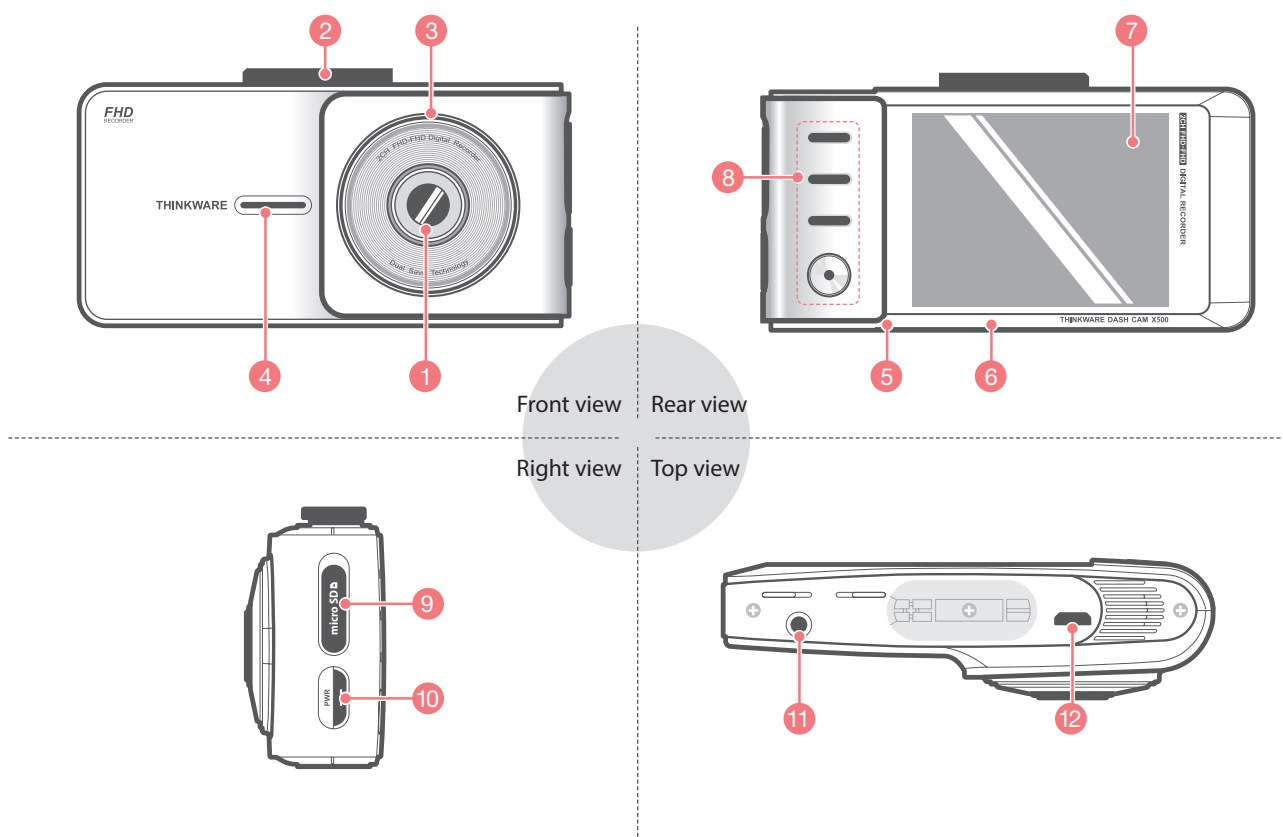

Rear View Camera

1-3. Product Overview



No.	Name	Description
1	Camera Lens	Front facing camera for video recording
2	Mount Connector	Connects to the windshield mount
3	Security LED	Operation indicator lights that are used to visually indicate that the vehicle is equipped with a dash cam
4	Speaker	For voice guidance and alert/notification sounds
5	Reset	Press to force the device to restart
6	Microphone	Records audio along with video
7	LCD Screen	Provides Live View, video playback, and access to dash cam configuration
8	Control Buttons	Control Buttons to navigate through user menu on the screen
9	Memory Card Slot	Location for the memory card
10	Power  Button	Press and hold for 3 seconds to turn the device on/off
11	DC-IN	Connects to power cable
12	V-IN Socket	Connects to rear view camera. (Optional rear view camera is not included and requires separate purchase)

1-4. Inserting a Memory Card

1-4-1. About Memory Cards

- ▶ UHS MicroSD card must be used with a storage capacity of 16GB, 32GB, or 64GB. It is strongly recommended that minimum 16GB memory card is used for full HD recording.
- ▶ The MicroSD card should be formatted every 2 weeks to maximize the lifetime of the memory card.

1-4-2. Installing a MicroSD Card

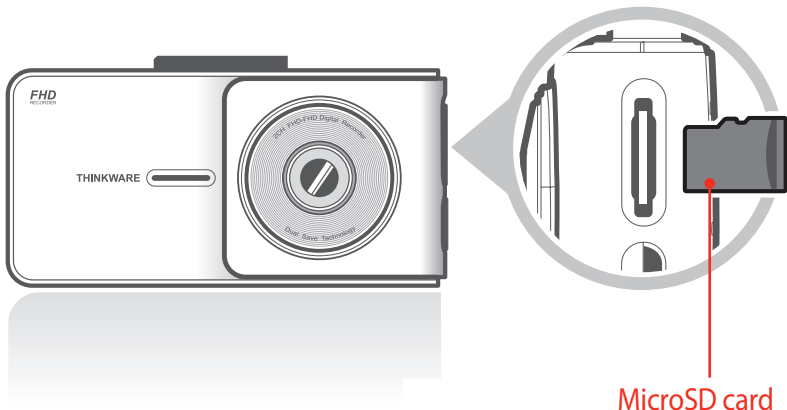

Open the slot cover and insert the MicroSD card into the slot with the metal contacts facing up toward the mount connector and push until it locks into place.

← **Inserting the memory card**

→ **Removing the memory card**

Press the end of MicroSD card until it clicks out from the slot. Pull out the MicroSD card and close the slot cover.

MicroSD card

▶ Device only supports MicroSDUHS-I card with capacity of 16GB or higher

Do not apply excessive force on the MicroSD card or attempt to insert it in the wrong direction as it may cause damage to the MicroSD card and the card slot.

Cautions

- The MicroSD card should be tested for errors on a regular basis and as the memory card is a consumable item, it should be replaced periodically.
- THINKWARE shall NOT be responsible for any problems and/or damages that may occur from not using genuine or authorized parts and accessories. It is strongly recommended that THINKWARE memory cards are used to minimize memory card error.
- Ensure that the device is completely off before removing the MicroSD card to avoid damages to the memory card.
- To prevent loss of important data, frequently copy recorded videos from MicroSD card to another storage device such as personal computer for back up.

1-5. Vehicle Installation

1-5-1. Connecting the Device and the Mount

- ① Align the mount with the connector (A), and slide it towards (B) until it clicks into place.
- ② Remove the protective film from the camera lens.

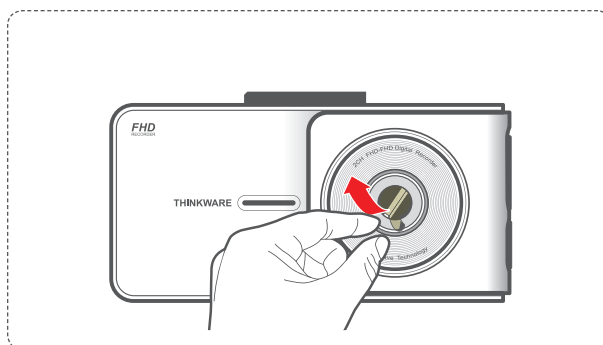
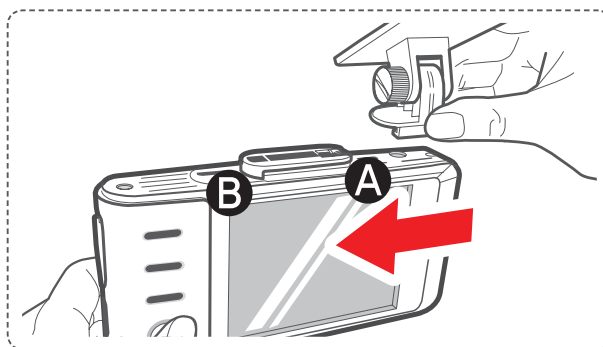

1-5-2. Installing the Device

- ① Clean the area on the windshield where the dash cam will be installed.
- ② With dash cam main unit still attached to the mount, remove the protective tape from the back of the mount.
- ③ Attach the adhesive side of the mount on the windshield where it has an unobstructed view of the road but does not interfere with the driver's view.

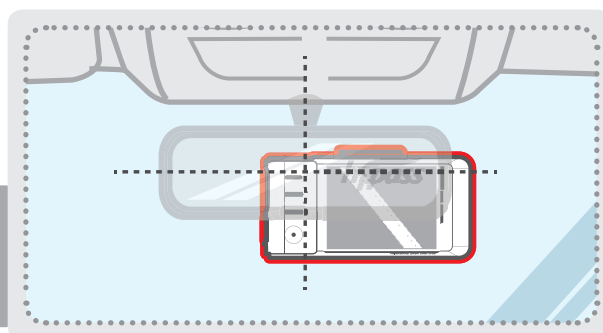
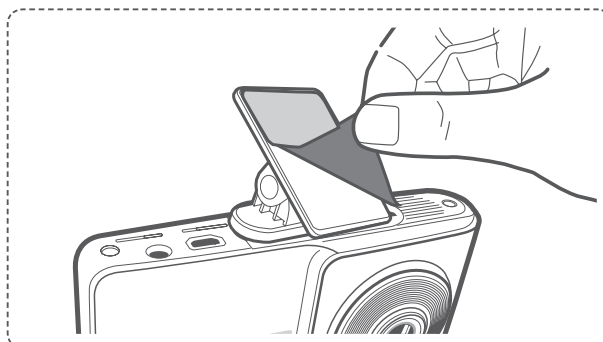

TIP

The camera is located on the left side of the main unit so install the dash cam on the right of center behind the rearview mirror.

TIP

To ensure that the mount is safely secured, it is recommended that you separate the device from the mount after installation and press the mount towards windshield for 5 minutes to maintain pressure. Allow 24 hours until the adhesive on the mount has set before connecting the dash cam.

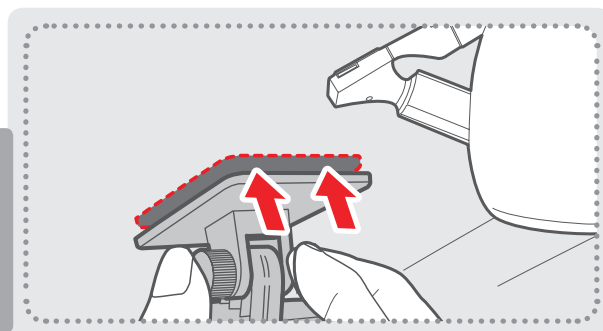

1-5-3. Connecting to power

- ① Connect the power cable to DC-IN socket of the device.
- ② Plug the car charger adapter end of the power cable into a 12V DC vehicle power socket.
- ③ Arrange the wire by using the adhesive cable holders as shown below.

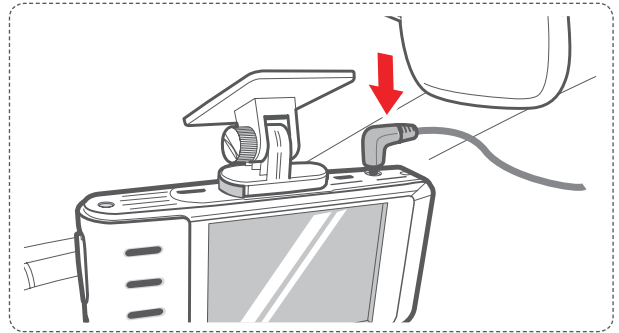

- ④ Adjust the camera so that the dash cam is facing forward and is level with the road.

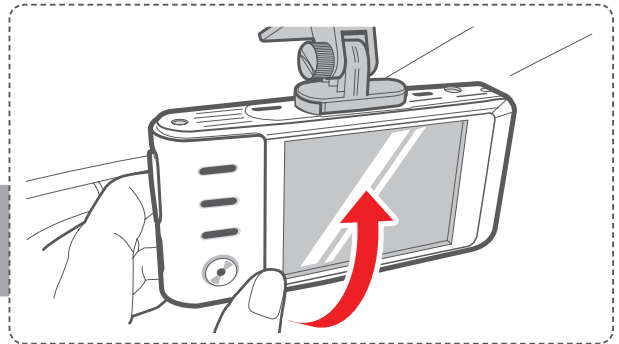

TIP

After installation, turn on the dash cam and use the live view on the LCD screen to adjust the camera angle.

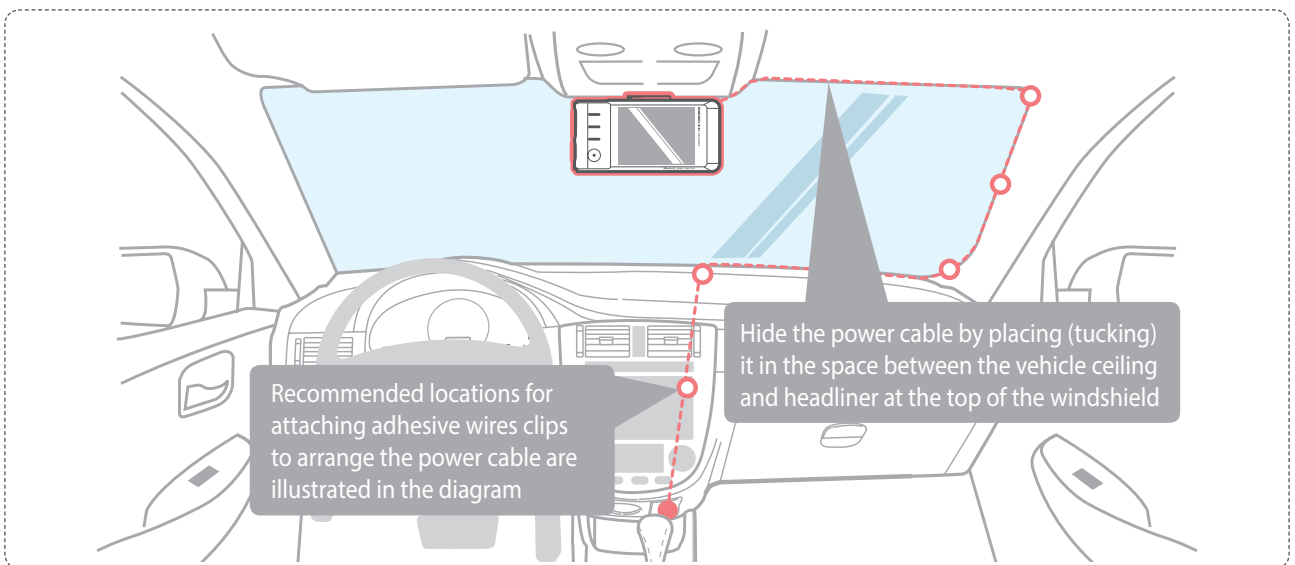

For more information on the power cable routing instruction, please visit Thinkware homepage. (www.thinkware.com)

Preventing Vehicle Battery Discharge

- Depending on the make and model of your car, the power may be supplied to the dash cam even with the ignition turned off. This may result in vehicle battery discharge.
- Some vehicles with multiple power sockets might be equipped with at least 1 outlet that does not shut off the power with the ignition. Test each power outlet to ensure you connect to an outlet that shuts off with vehicle ignition.

2. Basic Operations

2-1. Turning the Device Power On/Off

- ▶ Once connected to the vehicle, the device will automatically turn on and off with vehicle ignition.

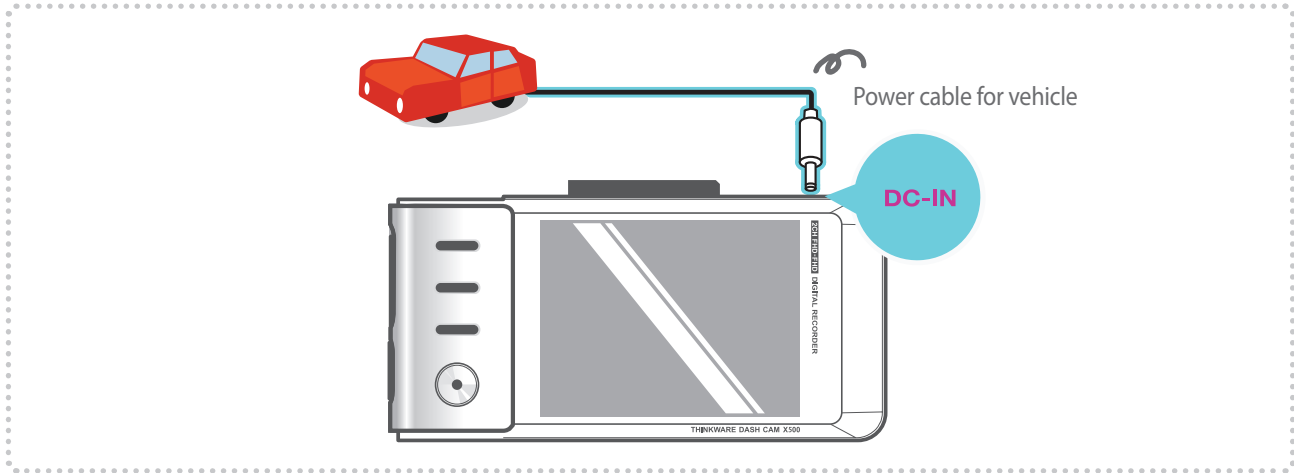

- ▶ To manually turn the device on/off, press and hold the Power button (⏻) for 3 seconds.

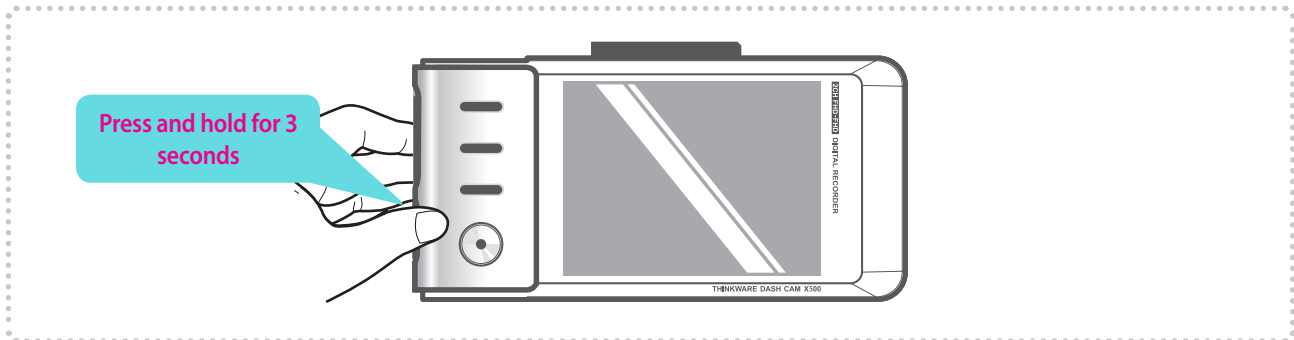

2-2. Road Safety Warning

2-2-1. Safety Camera Alert

- ▶ Safety Camera Alert : Using GPS and database, safety camera alert will warn the driver when approaching traffic enforcement zones such as red light camera, speed camera, average speed camera, and mobile speed zones.

- ① Enable the safety camera alert feature in "LCD Menu > Settings > Road Safety Settings > Safety Camera Alert"

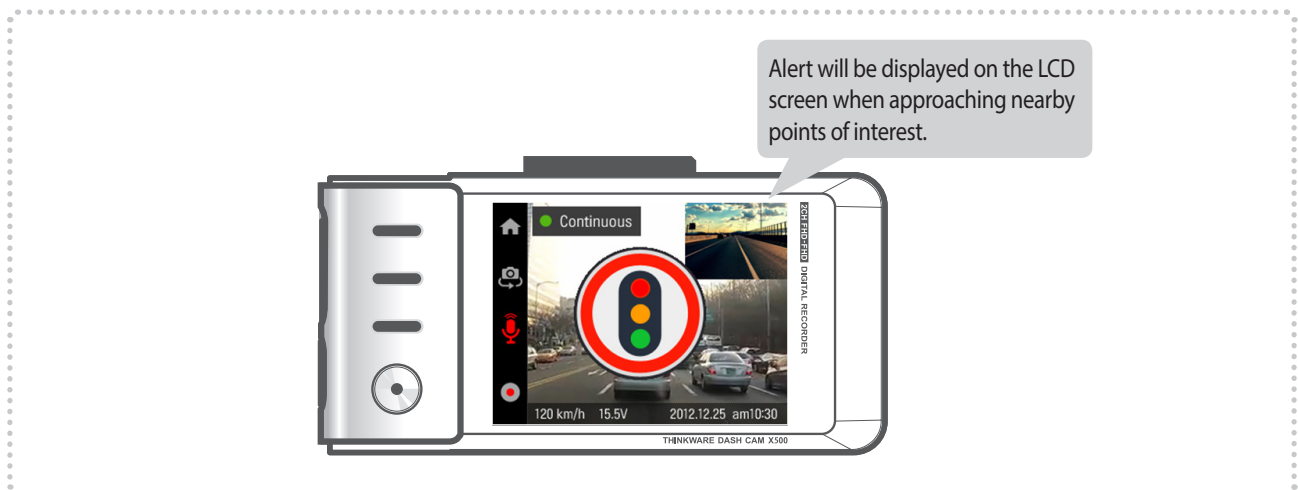
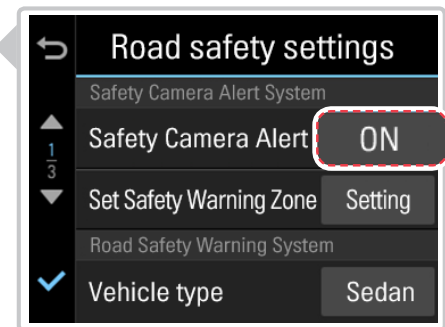

- ▶ Resetting GPS

└ Built-in Internal GPS can be reset by selecting "Main Menu > About Device > GPS Info > Reset GPS"

Cautions

- This feature may not be available in some countries.
- GPS may be affected by weather conditions, satellite signal, and/or surrounding geographical features.
- Coated windshields can interfere with GPS signal which may result in poor or blocked GPS reception.
- Other electronic devices and/or equipment may interfere with GPS signal if placed too close to the dash cam.

2-2-2. Advanced Driver Assistance Systems (ADAS)

► ADAS Auto Calibration

1. ADAS settings must be calibrated before use.
2. Auto Calibration will initiate when driving on a straight road at a speed greater than 30km/h (18mph) for more than 1 minute.

Align blue line with center of the hood

Align green line with the front edge of the hood

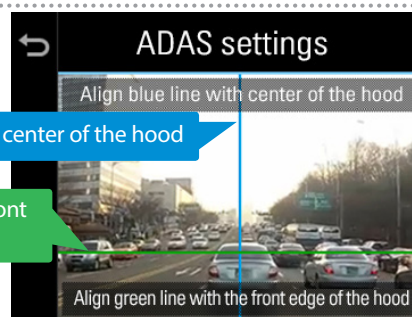

► Lane Departure Warning System (LDWS)

Lane departure warning alerts the driver when the vehicle moves out of its lane. LDWS is activated only when the vehicle is moving faster than 50km/h (30mph)

* Default setting : 80km/h (approx 50mph)

- ① Enable the LDWS feature in "LCD Menu > Settings > Road Safety Settings > LDWS"
- ② Configure the LDWS settings in "LCD Menu > Settings > Road Safety Settings > Left/Right LDWS sensitivity"



► Forward Collision Warning System (FCWS)

Forward collision warning alerts the driver when the vehicle is approaching the vehicle ahead at a high closing rate. FCWS is activated only when the vehicle is moving faster than 30km/h (18mph)



<1st stage initial FCWS warning>



<2nd stage FCWS warning when fast approaching the vehicle ahead after initial warning was given>

- ① Enable the FCWS feature in "LCD Menu > Settings > Road Safety Settings > FCWS"
- ② Configure the FCWS setting in "LCD Menu > Settings > Road Safety Settings > FCWS sensitivity"

► Front Vehicle Departure Warning (FVDW)

Front vehicle departure warning alerts the driver when the vehicle ahead starts to move forward from a complete stop.

- └ The vehicle must be at a complete stop for more than 4 seconds in order for the FVDW notification to be activated.



- ① Enable the FVDW feature in "LCD Menu > Settings > Road Safety Settings > FVDW"

Cautions

- Driving at night, tunnels, heavy rain/snow, road surface conditions can affect accuracy of ADAS features.

2-3. Recorded Files

► Recorded video files are saved in the folder by date and hour in the MicroSD card.

└ Files are created based on the time when the videos are recorded.

REC_2014_04_01_23_37_14_F

Year Month Day Hour Minute Second Front view recording

REC_2014_04_01_23_37_14_R

Rear view recording
(optional rear view camera must be installed)

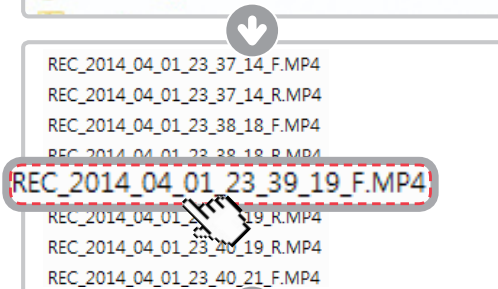
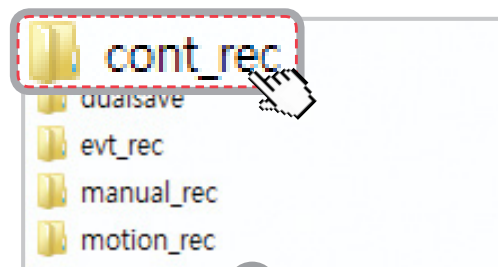

└ As a loop-recording surveillance product, the dash cam will automatically overwrite oldest file in the memory card once the memory is full. However, event recording and manual recording videos are stored in separate locations and will be protected from file overwriting.

Cautions

- Do not use the MicroSD card as an external storage device.
- Do not tamper with the system files within the in the MicroSD card. This may result in unexpected behavior during operation.

2-4. Recording Videos While Driving

2-4-1. Continuous Recording Mode

- ▶ Videos are recorded in 1 minute segments and saved as files in the MicroSD card under the folder named "cont_rec".



2-4-2. Incident Recording During Continuous Recording Mode

- ▶ When the dash cam detects impact, it will immediately store the 10 seconds prior and after the impact.
- ▶ The 20-second impact recording is saved on the MicroSD card under the "evt_rec" folder. Note that the dash cam will detect impact as incident only if the level of impact is greater than the sensitivity of the G-sensor set in the user configuration.

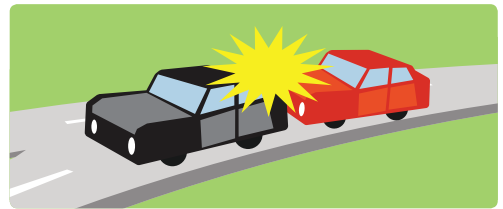

Cautions

- Driving over speed bumps, manholes, or uneven roads at high speeds can also be detected as an impact and may trigger incident recording.
- The device can record up to 1 minute of incident recordings in the case of continuous impacts or multiple accidents.
- The duration of incident footage recorded may vary according to the device settings.

2-4-3. Dual Save™ (Internal Memory Backup)

► Dual Save is a Thinkware proprietary technology that utilizes built-in memory as secure backup in addition to the MicroSD memory card. Dual Save technology guarantees incident video recording using internal memory in case of an accident that causes damage to the MicroSD memory card.

- ↳ In addition to saving incident video files to MicroSD card at the time of the accident, Dual save stores another backup copy onto the built-in internal memory in case there has been a damage to either the main unit or the MicroSD card that might result in failure to save incident videos on the external memory
- ↳ When Dual Save is activated, it will immediately store the previous 4 seconds prior to impact and start recording video for next 2 seconds for total of 6 second video clip

↳ **View Dual Save Video Files:** Video recorded and stored on the internal backup memory through Dual Save technology can be viewed in the list located at "Dual Save Videos > Videos".

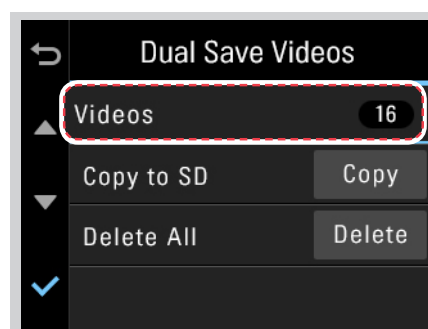

↳ **Copy Dual Save Video Files:** Video recorded and stored on the internal backup memory through Dual Save technology can be copied to MicroSD card using copy menu located at "Dual Save Videos > Copy to SD". Ensure that a MicroSD card is present in the device

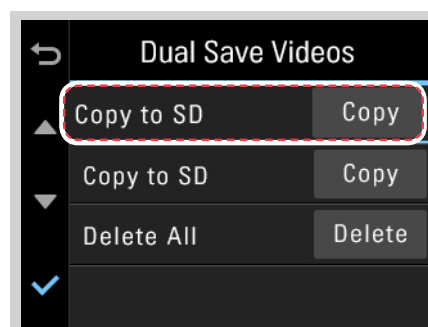

Cautions

- Dual Save technology saves duplicate copy of the recorded video as secure backup to the internal memory so the internal memory life span may be affected by G-sensor user setting, road conditions, and driving behavior which directly impact the frequency of incident recordings.
- Driving over speed bump, manhole, or uneven road at high speed can also be detected as incident.
- Professional product service is required for replacing internal memory.

2-5. Recording Videos While Parked (Optional Accessory)

This feature is available only when the dash cam has been hardwired directly to the vehicle battery. Separate purchase for the hardwiring cable accessory and professional installation is required.

2-5-1. Incident Recording

- ▶ When the dash cam detects impact while parked, it will immediately store the 10 seconds prior and after the impact.
 - The 20-second impact recording is saved on the MicroSD card under the "parking_rec" folder.



2-5-2. Motion Detection Recording

The dash cam and the optional rear view camera are both equipped with motion detectors which are used to detect motion that initiates video recording while the vehicle is parked.

- ▶ When the dash cam detects motion while parked, it will immediately store the previous 10 seconds prior to the activation of motion detection start recording video for the next 10 seconds.
 - The 20-second motion detection recording is then saved on the MicroSD card under the folder named "motion_rec".

Cautions

- The device can record up to 1 minute for continuous impacts in the case of multiple collisions.

2-6. Manual Recording

In addition to recording accidents, the dash cam allows the user to initiate manual recording mode to capture scenery and/or places while driving. This feature can also be used to save video as witness where the installed vehicle is not directly involved in an accident. Video files saved during manual recording mode are stored in a separate location on the memory card and will be protected from video overwriting in continuous recording mode.

- ▶ **Briefly press the REC**  button to start recording. The device will record video for 1 minute (10 seconds before and 50 seconds after) as of the time when the button is pressed. The recorded video will be saved under the “manual_rec” folder.

Note that when manual recording is initiated, the previous 10 seconds prior to pressing the button will be saved so even if you just missed a scene, you can still capture and safely store the video by initiating manual record within 10 seconds of the event.

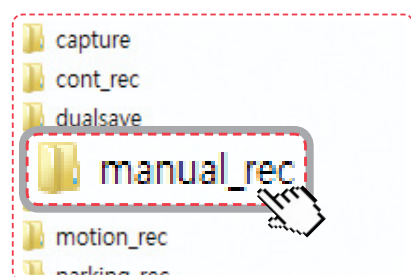

Cautions

- When the allocated storage for manual recording videos is full, oldest video file will be replaced by the new recorded video.

2-7. Formatting MicroSD Card

- ▶ Select "Memory Card Format" menu located at "Mem Card Settings > Memory Format".

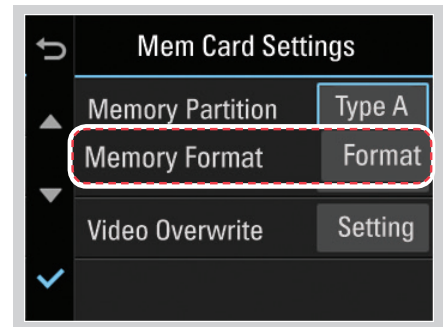

Cautions

- The MicroSD card should be formatted every 2 weeks to maximize the lifetime of the memory card.

2-8. Upgrading Firmware

- ▶ The system will automatically be updated if the MicroSD card contains the firmware upgrade file.
 - └ The device restarts automatically after the upgrade has been completed.
- ▶ Make sure your device is always up to date with latest firmware. Please check back frequently at THINKWARE website (www.thinkware.com) for the latest firmware updates.

3. LCD Screen

3-1. Main Menu

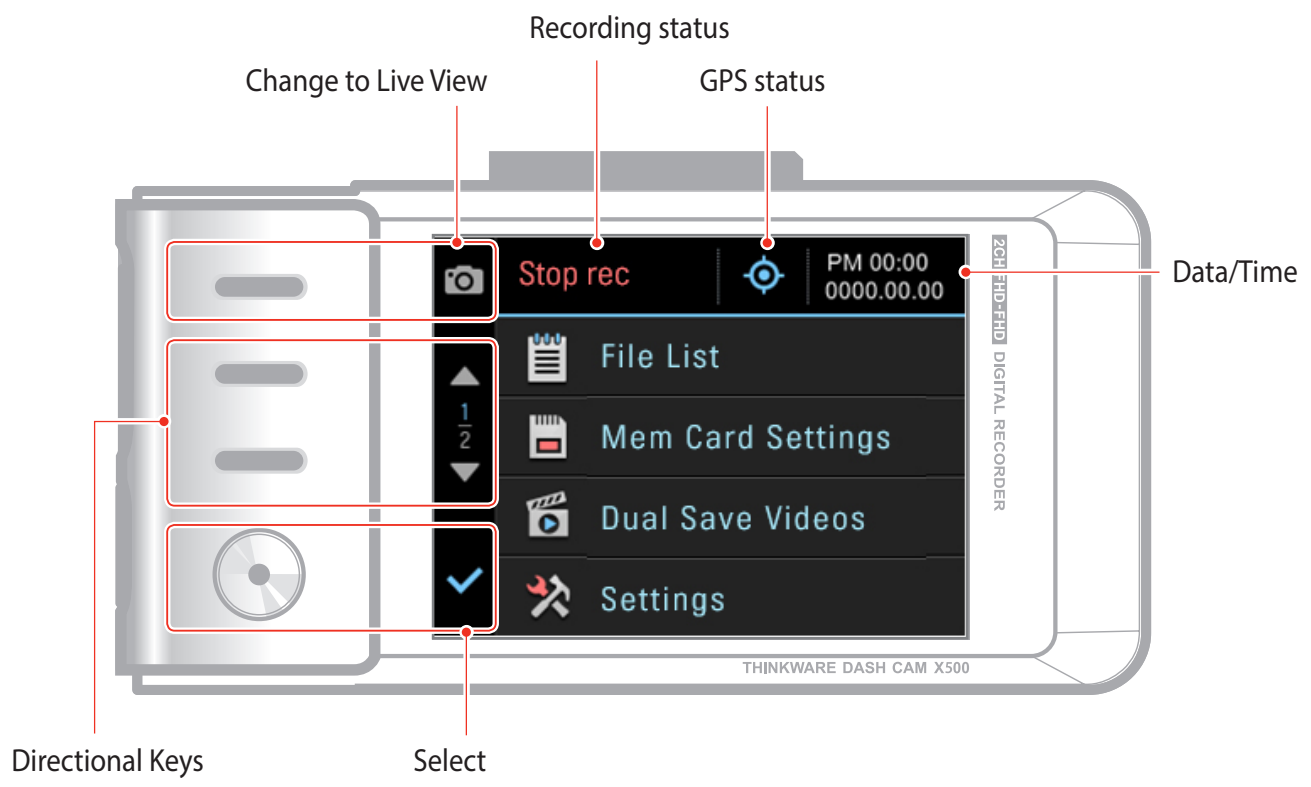

3-2. Live View

LCD screen can be used to verify current recording view.

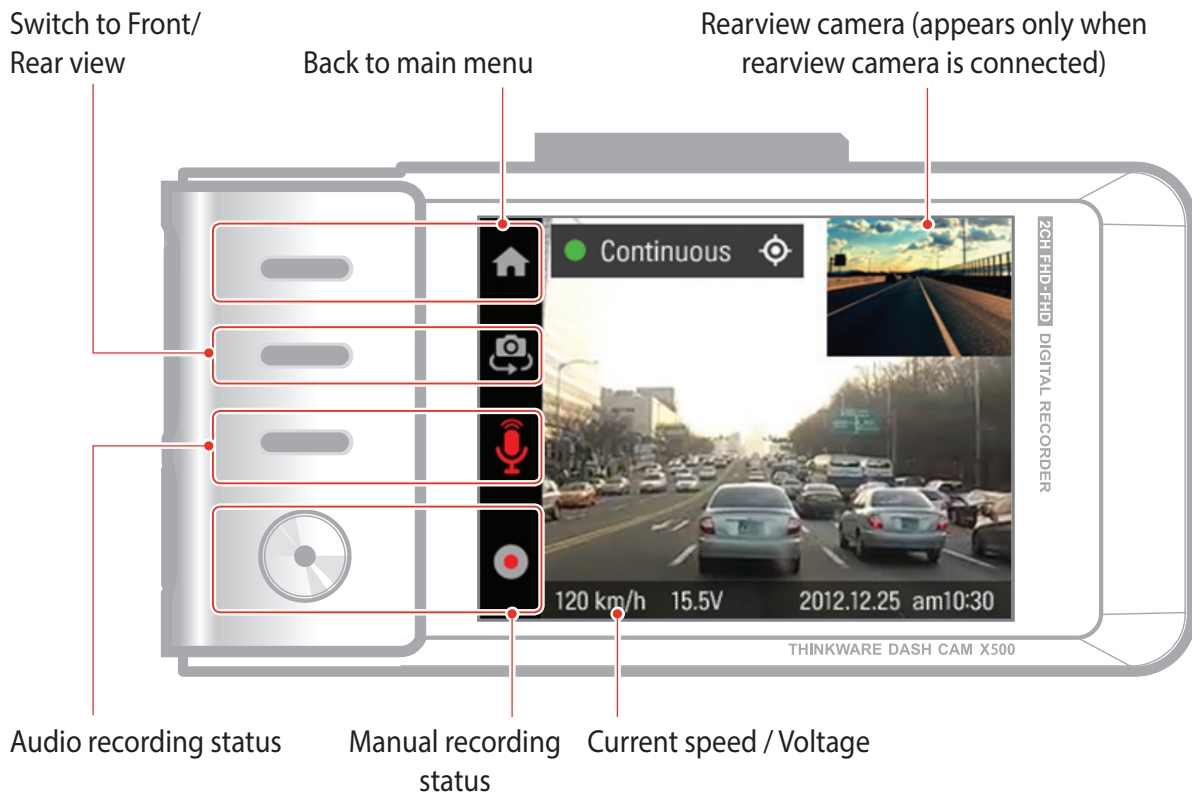

3-3. File List

Recording will suspend when browsing through video list and settings menu. Visual notification will appear on the screen to confirm the suspension of recording prior to entering the menu.

3-3-1. File List - 1

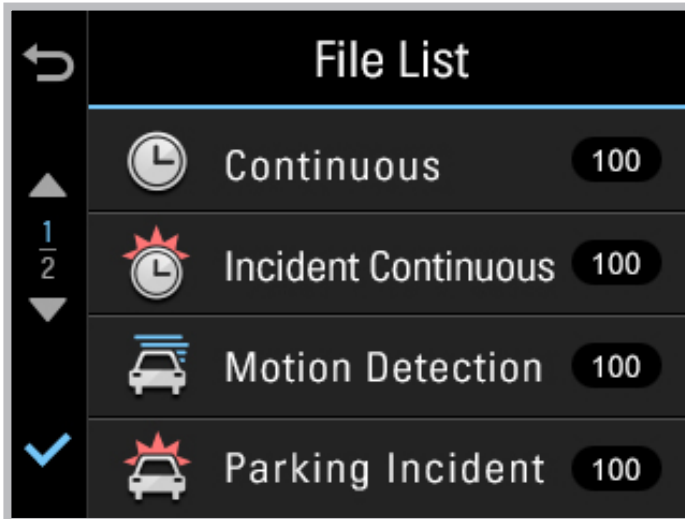

- ▶ **Continuous** : Lists loop recording videos during continuous mode (in 1 minute segments)
- ▶ **Incident Continuous** : Lists incident recording videos during continuous mode
- ▶ **Motion Detection** : Lists motion detection recording videos during parking surveillance mode
- ▶ **Parking Incident** : Lists incident recording videos during parking surveillance mode
- ▶ **Manual Recording** : Lists manual recording videos initiated by selecting button

Cautions

- The configured storage capacity may be different from the actual capacity by approximately 30 to 40MB.

3-3-2. File List - 2

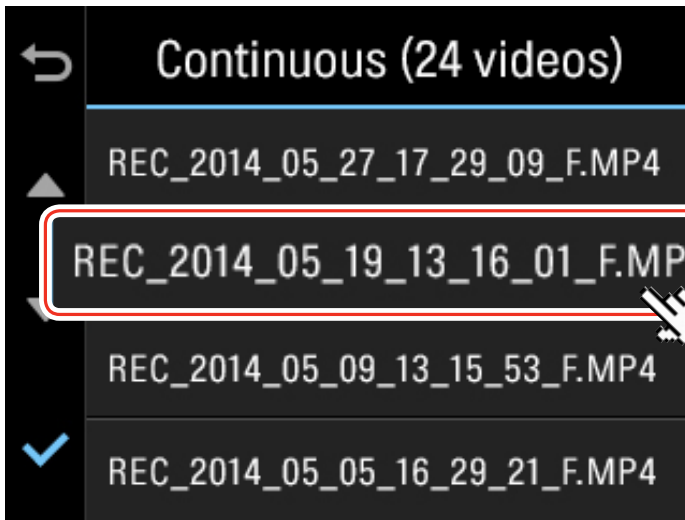

Recording will stop when accessing on-screen menu.



Video playback with 3X zoom



3-4. Memory Card Settings

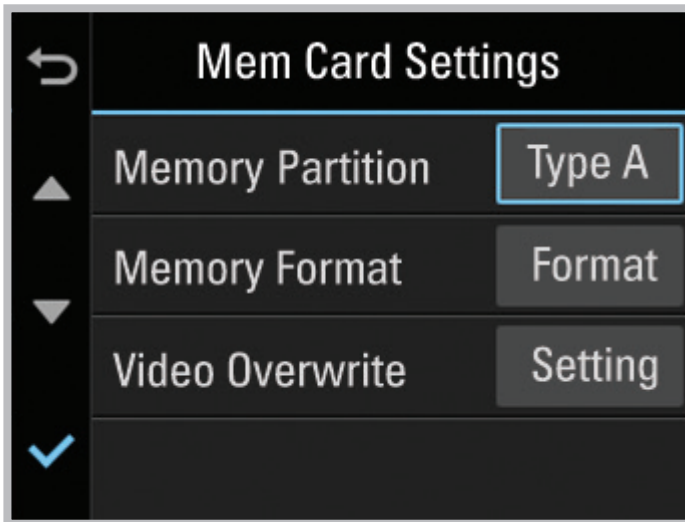

- ▶ **Memory Partition** : Sets how storage space on the memory card will be allotted for each recording mode
 - └ Type A (recommended) : Optimized for continuous recording
 - └ Type B : Optimized for incident and motion detection during parking surveillance
 - └ Type C : Optimized for continuous and incident recording
- ▶ **Memory Format** : Formats the MicroSD card
 - └ Formatting will completely erase all video files stored in the memory card
- ▶ **Video Overwrite** : Sets the overwriting option which will allow new video files to overwrite oldest video in storage reserved for each mode

Cautions

- It is recommended that you back up data before formatting the memory card.
- Once you format the memory card, all data will be deleted and cannot be restored.
- The method for formatting a MicroSD card might vary depending on the computer operating system.

3-5. Dual Save Videos

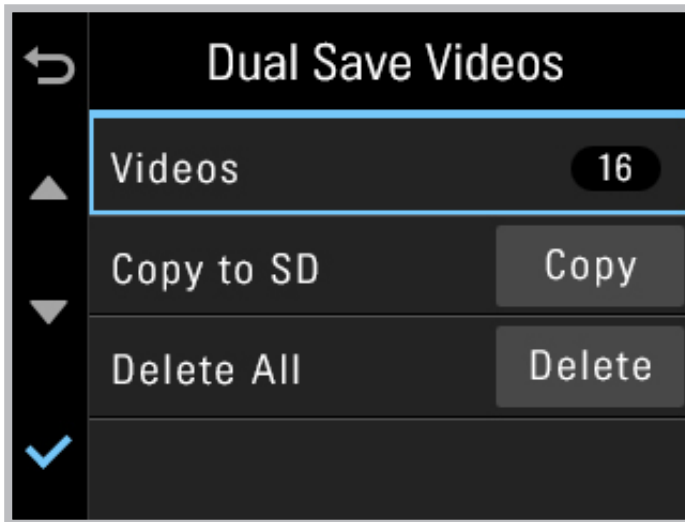

- ▶ **Videos** : View Dual Save video list
- ▶ **Copy to SD** : Copy all videos saved on the internal memory to MicroSD card
- ▶ **Delete All** : Delete all videos saved on the internal memory

3-6. Settings > Camera Settings



- ▶ **Brightness-F/R** : Sets the video recording brightness for front/rear camera
- ▶ **Wide Dynamic Range** : Sets the WDR mode to record clear video even under large variation of backlighting illumination.

3-7. Settings > Record settings

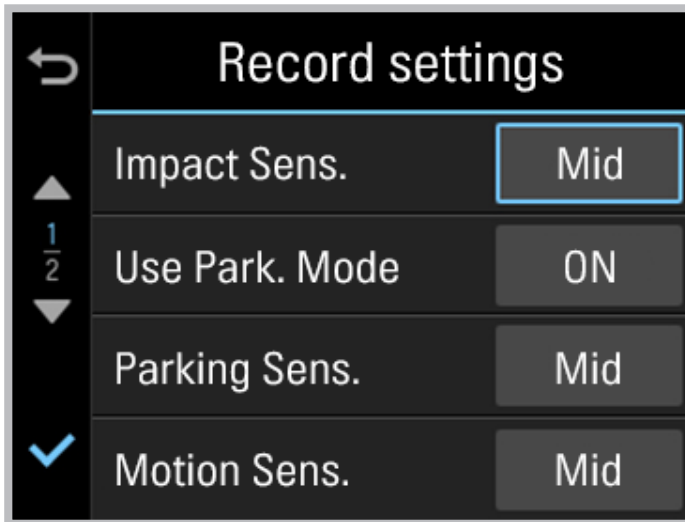

- ▶ **Impact Sensitivity** : Sets the impact sensitivity level
- ▶ **Use Parking Mode** : Monitors vehicle ignition status to automatically convert to parking mode when the vehicle engine is turned off
- ▶ **Parking Sensitivity** : Sets the impact sensitivity during parking recording mode
- ▶ **Motion Detection Sensitivity** : Sets the motion detection sensitivity during parking recording mode
- ▶ **Off Timer** : Sets the timer for the dash cam to automatically shut down in parking mode to prevent from draining the vehicle battery
- ▶ **Off Voltage** : Sets the voltage level for the dash cam to automatically shut down in order to prevent from draining the vehicle battery

Cautions

○ Tips on sensitivity

It is recommended that you set the sensitivity according to vehicle type. High sensitivity setting is recommended for cars with softer ride such as luxury sedans; while low sensitivity setting is recommended for cars such as performance cars, trucks, or SUVs which tends to have stiffer suspension settings.

- It is recommended to format the memory card when settings have been changed.
- Backup important video files before formatting the memory card.

3-8. Settings > Road Safety settings

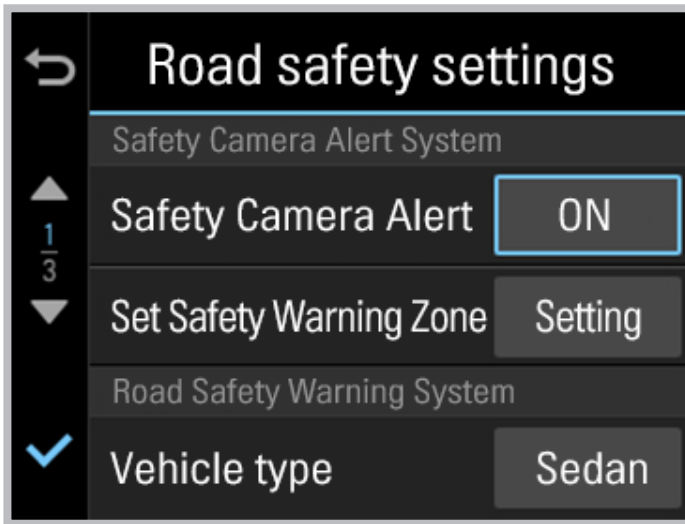

► Road Safety Warning System

- └ **Road safety settings** : Sets audible notifications for road safety warnings.

► Advanced Driver Assistance Systems (ADAS)

- └ **Vehicle type** : Sets the vehicle type to be used to optimize Advanced Driver Assistance Systems (ADAS) features
- └ **ADAS setup screen** : Calibration setting for the ADAS features
- └ **Sets the vehicle type to be used to optimize Advanced Driver Assistance System (ADAS) features** : Sets the LDWS driver assistance notification.
- └ **LDWS Initialization** : Initializes LDWS settings
- └ **LDWS sensitivity** : Sets the lane departure detection sensitivity.
(It is recommended that the sensitivity is set at high for wider vehicles)
- └ **LDWS speed** : Sets the speed at which the LDWS notification is enabled.
- └ **Forward Collision Warning System (FCWS)** : Sets the FCWS driver assistance notification.
- └ **FCWS sensitivity** : Sets the forward collision detection sensitivity.
- └ **Front Vehicle Departure Warning** : Sets the notification to alert the driver when the front vehicle has started to move forward from complete stop.

3-9. Settings > System Settings

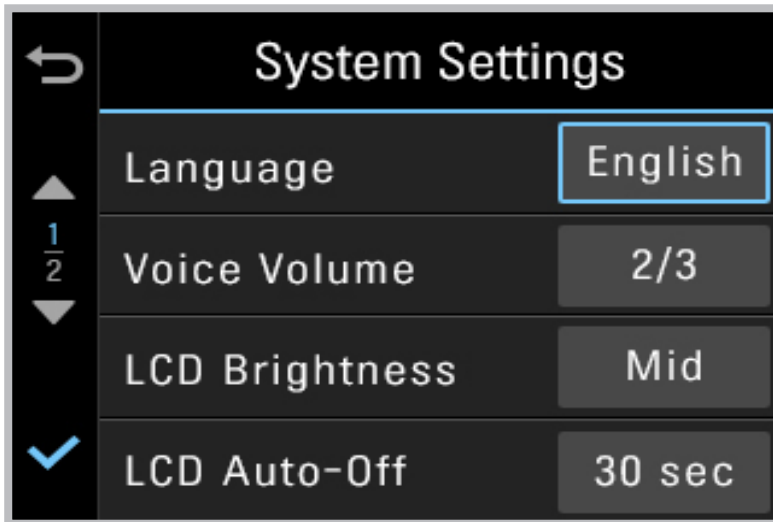

- ▶ **Language** : Sets dash cam system language
- ▶ **Voice Volume** : Sets the volume level
- ▶ **LCD Brightness** : Sets the brightness of the LCD screen
- ▶ **LCD Auto-Off** : Sets the time for LCD auto shut off
 - └ When LCD is off, pressing any button will turn the LCD screen back on
- ▶ **Security LED** : Sets the pattern for security LED
- ▶ **Time Zone** : Sets the time zone
- ▶ **Daylight Saving Time (DST)** : Sets the daylight saving time
- ▶ **Speed Unit** : Sets the unit for the vehicle speed

3-10. About Device

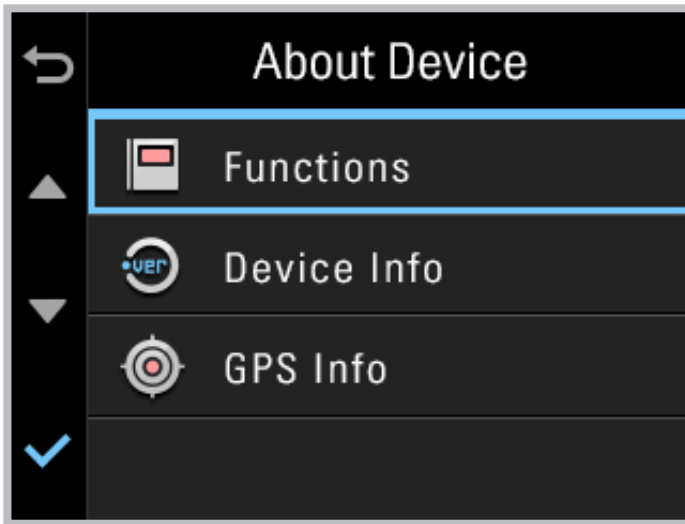

- ▶ **Functions** : Help for device features
- ▶ **Device Info** : Information on device and firmware
 - └ **Factory Reset**: Restores to factory setting
- ▶ **GPS Info** : View GPS information
 - └ **GPS Initialization**: Reset GPS

4. PC Viewer Software

4-1. Thinkware Dash Cam PC Viewer

Thinkware Dash Cam Viewer for Windows/MacOS is provided which can be used to watch videos recorded with the dash cam. The video files recorded by the dash cam are in one minute segments and the PC viewer allows the user to watch these segments as a single continuous video.

The setup file for the Thinkware Dash Cam PC Viewer is included in the MicroSD card within the package. Please check THINKWARE homepage (www.thinkware.com) for the latest Dash Cam PC Viewer application.

4-1-1. Thinkware Dash Cam PC Viewer Software

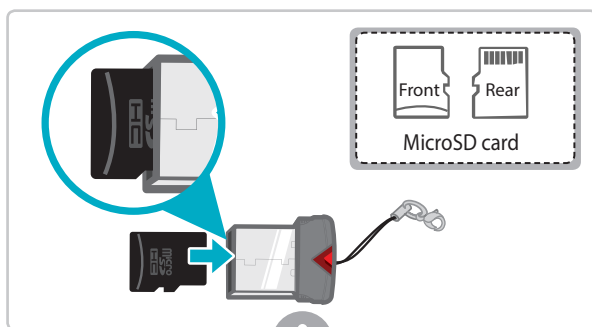

① Insert the MicroSD card into the USB MicroSD card reader (included in the package) with front side facing up as shown in the illustration.

② Connect the USB MicroSD card reader to the PC.

Ensure that the USB card reader is correctly oriented when inserting it into the USB drive

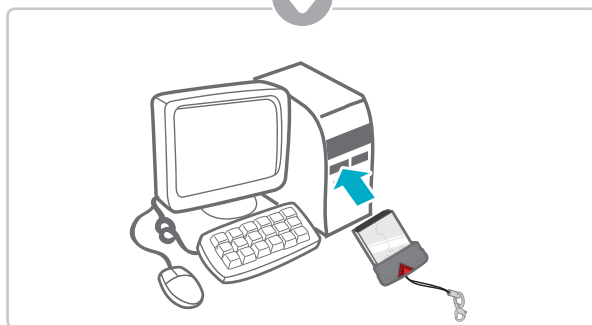

Removing MicroSD card

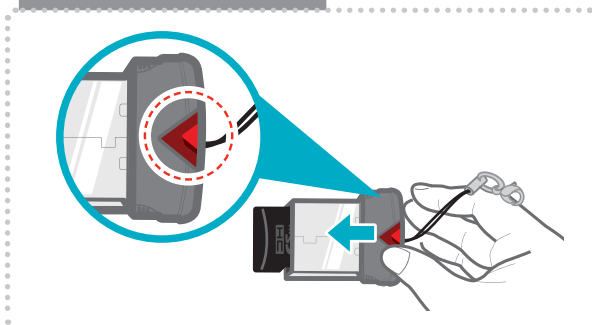

4-1-2. Installing Thinkware Dash Cam Viewer

Windows



- ① Double-click the Thinkware Dash Cam Viewer setup file saved in the MicroSD card to initiate program installation.
- ② Double-click the application icon once PC Viewer installation completes and the application main screen will then appear.

Cautions

- System requirements :
Windows XP (32 bit), Windows 7 (32 /64 bit),
Windows 8.x (32/64 bit)

MAC

- ① Move the file named "Dashcam Viewer.zip" stored in the MicroSD card to the desktop.
- ② Right click on the mouse and select "Open With" > "Archive Utility" to launch the Thinkware Dash Cam viewer application.

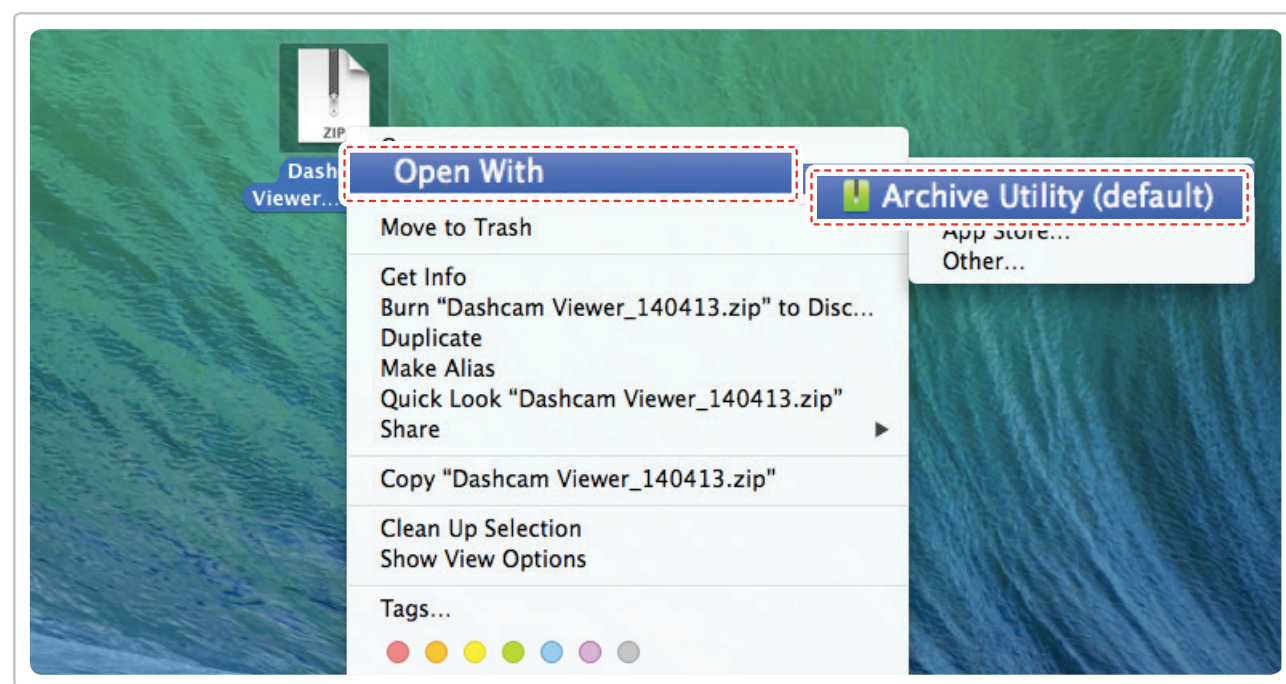

Cautions

- System requirements : MAC OS X 10.8 Mountain Lion or later (OS X 10.9 Mavericks, OS X 10.10 Yosemite)

4-1-3. Select the Device Drive for X500

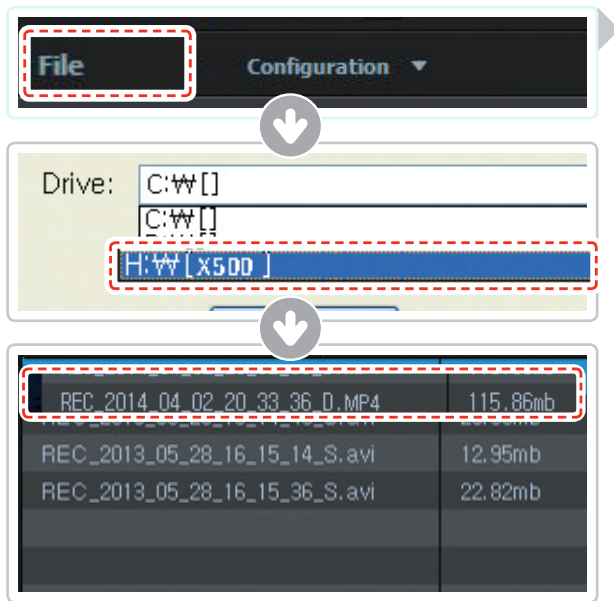

- ① Click **File** ▼ from menu and select the drive for the portable storage drive for the connected MicroSD card.
- ② Select any file from the list to load entire video playlist in the memory card.

Cautions

- The MicroSD card will not be recognized by the software until it has been initialized in the dash cam.
- It is recommended that the user record at least one video clip on the MicroSD card with the dash cam unit before accessing the Thinkware Dash Cam PC Viewer.

4-1-4. Thinkware Dash Cam Viewer Overview

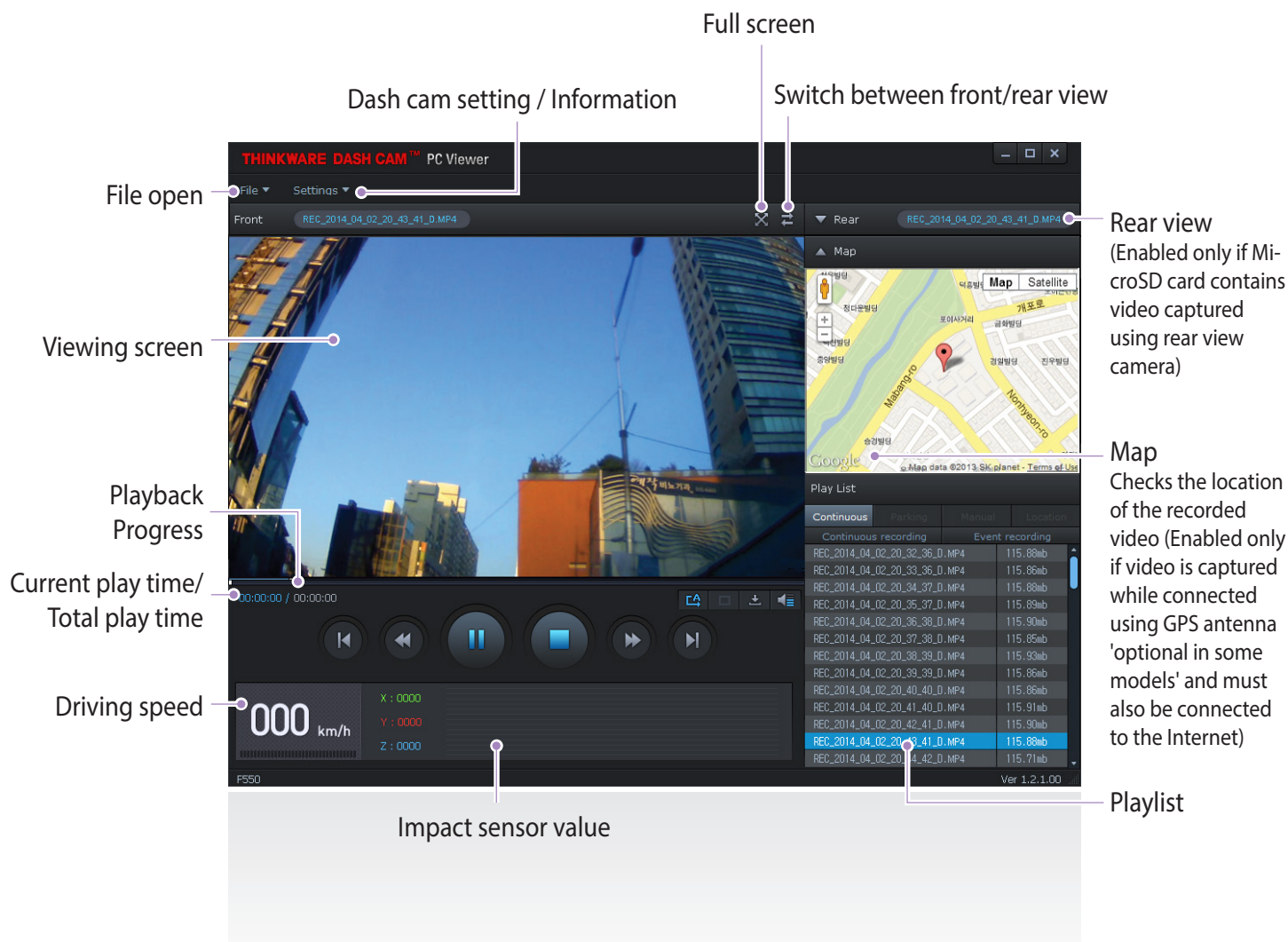

No.	Name	Description
⏮	Play Previous	Plays the previous file before the current file
⏪	Rewind by 10 Sec	Rewinds the current file being played by 10 seconds (If selected, it continues to rewind by 10 seconds)
▶/⏸	Play/Pause	Plays the recorded file / temporarily pauses playback
■	Stop	Stops the file being played. The playback status resets to the starting point of the video.
⏩	Fast-forward by 10 Sec	Fast-forwards the current file being played by 10 seconds (If selected, it continues to fast-forward by 10 seconds)
▶	Play Next	Plays the next file after the current file
🔄	Auto Play	Automatically loops the video back to beginning once the end has reached
📏	Zoom	Sets the video expansion ratio (0.5x / 1.0x / 1.5x / 2.0x)
⚙️	Screen Setting	Sets brightness/speed of the video
💾	Save	Saves the video in play
🔊	Volume	Sets the volume of the playback

4-1-5. View Video Playlist

- ▶ Select appropriate folder (Continuous Recording, Incident Recording, Manual Recording, Parking Motion, Parking Incident) to see the playlist for each recording mode.

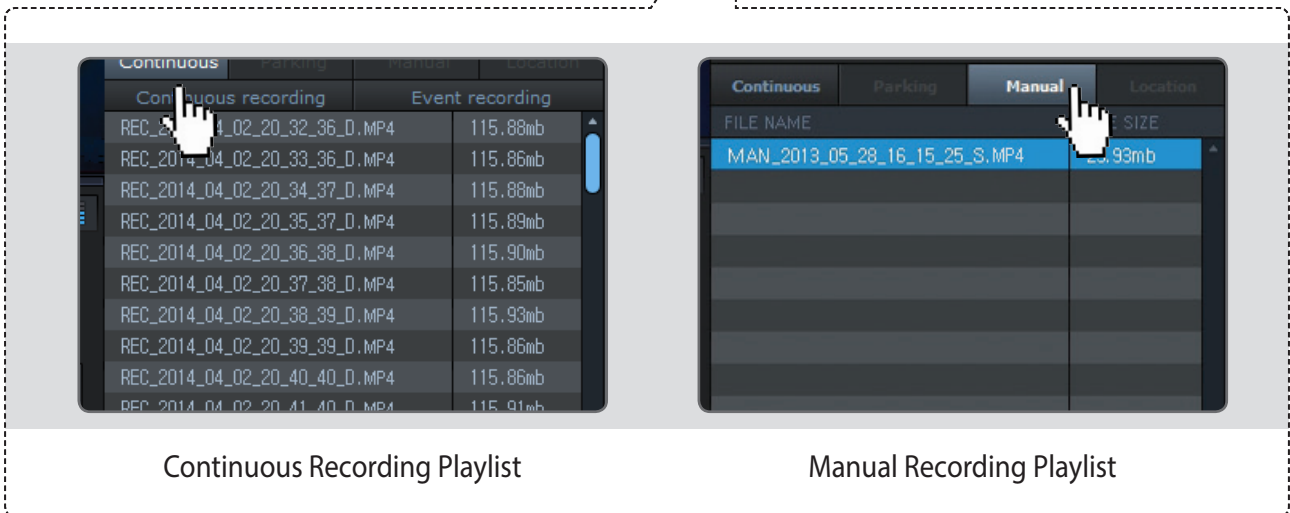
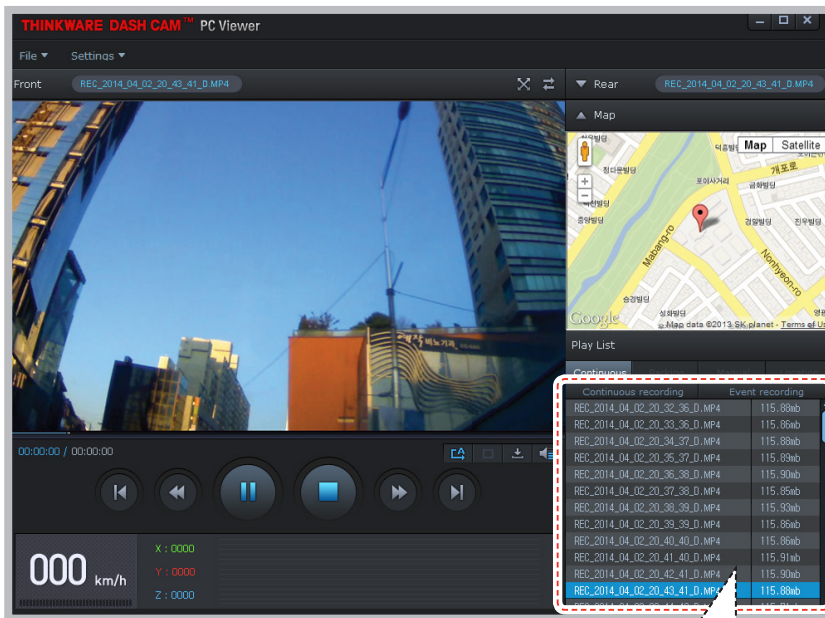

5. Specifications

5-1. Specifications

The specifications of this product may change without prior notice for product improvements.

Item	Standard	Note
Model	X500	
Size/weight	104.3 x51.4 x 29.3mm / 109g 4.1 x 2.02 x 1.15 inches / 0.24lbs	
Display Panel	2.7"LCD (320x240)	
Capacity	MicroSD card (UHS-I)	16GB/32GB/64GB
Recording mode	Continuous Recording Mode	Records in 1 minute segments
	Incident Recording Mode	
	Manual Recording Mode	
	Parking Surveillance Mode	Optional hardwiring cable and installation are required for continuous supply of power when vehicle ignition is off.
	Audio Recording	
Camera	2.19 Megapixel, 1/2.9" CMOS	Same for rear camera
Viewing angle	Approximately 140° (diagonally)	Same for rear camera
Video	Full HD (1920 x 1080/H.264/extension MP4)	Same for rear camera
Frame rate	1 channel (Front view) : up to 30 fps	Same for rear camera
Audio	PCM (Pulse code modulation)	
Acceleration sensor	3-axis acceleration sensor (3D, ±3G)	Adjustable impact sensitivity (5 levels)
Rear camera	Support V-IN port	Optional accessory that requires separate purchase.
GPS	Embedded GPS	
Input power source	DC 12/24V	Rear view camera: DC 3.3V
Current consumption	2CH: 3.5W/1CH: 2.5W (mean)	Based on fully charged super capacitor/ LCD off
Auxiliary power unit	Super Capacitor	
Warning sound	Embedded speaker	Voice (buzzer sound) guidance
Operation/Storage Temperature	-10°C to 60°C/ -20°C to 70°C 14°F to 140°F/ -4°F to 158°F	
Connection Interface	1 x V-IN port (Micro USB)	