

Always there to help you

Register your product and get support at
www.philips.com/welcome

CMD305A



User manual

PHILIPS

Contents

1 Important	2
Safety	2
2 Your car audio system	3
Introduction	3
What's in the box	3
Overview of the system	4
3 Before use	6
Install the car audio system	6
4 Get started	9
Power on	9
Change system settings	9
Set the clock	10
Select a source	10
5 Listen to radio	10
Select a radio region	10
Select a tuner sensitivity	10
Tune to a radio station	11
Store radio stations in memory	11
Tune to a preset station	11
Play with RDS	11
6 Use Bluetooth devices	13
Pair a device	13
Play audio from a connected device	14
Make a call	14
7 Play from a USB storage device	15
Control play	15
8 Listen to an external device	16
9 Use the dock	16
Compatible with Android™	16
Prepare for docking	16
Connect your phone	17
Adjust the dock bracket	18
Install the CarStudio application	19
Use the CarStudio application	20
Charge your phone	21
Undock your phone	21
Store the dock bracket	22
10 Adjust sound	22
Adjust the volume level	22
Mute sound	22
Use the DBB sound effect	22
Enable the max sound	22
Select a listening zone	22
Enable the full-range sound	23
Select a preset sound equalizer	23
Other sound settings	23
11 Adjust system settings	24
12 Additional information	25
Reset the system	25
Replace the fuse	25
13 Product information	26
14 Troubleshooting	27
General	27
About Bluetooth device	27
15 Notice	28
Compliance	28
Care of the environment	28
Copyright	29
Trademark notice	29

1 Important

Safety

Read and understand all instructions before you use the device. If damage is caused by failure to follow instructions, the warranty does not apply.

- Modification of the product could result in hazardous radiation of EMC or other unsafe operation.
- The device is designed for negative ground (earth) 12V DC operation only.
- To reduce the risk of traffic accidents, do not pick up or make a phone call, nor watch video when driving.
- To ensure safe driving, adjust the volume to a safe and comfortable level.
- Improper fuses can cause damage or fire. When you need to change the fuse, consult a professional.
- Use only the supplied mounting hardware for a safe and secure installation.
- To avoid short circuits, do not expose the device, to rain or water.
- The device shall not be exposed to dripping or splashing.
- Do not place any sources of danger on the device (e.g. liquid filled objects, lighted candles).
- Never insert objects into the ventilation slots or other openings on the device.
- Clean the device with soft, damp cloth. Never use substances such as alcohol, chemicals or household cleaners on the device.
- The dock is designed for Android-powered mobile phones only. Do not connect any other device to it.
- Risk of damage to the dock bracket: Do not place or hang any object on it.

- Risk of firing or damage to the car audio system: Do not place any other object into the compartment for dock bracket.
- Risk of damage to your phone: Unload your Android-powered mobile phone from the dock before you store the dock bracket.

2 Your car audio system

Congratulations on your purchase, and welcome to Philips! To fully benefit from the support that Philips offers, register your product at www.philips.com/welcome.

Introduction

With this system, you can:

- enjoy audio from USB storage devices, Android-powered mobile phones, and other external devices,
- listen to radio stations,
- charge your Android-powered mobile phone, and
- make phone calls.

You can enrich sound output with these sound effects:

- Dynamic bass boost (DBB)
- Automatic loudness control

Playable media:

- USB storage device
 - Compatibility: USB 2.0, USB 1.1
 - Class support: MSC (Mass Storage Class)
 - File system: FAT16, FAT32
 - Maximum capacity: 32 GB
 - Files: .mp3, .wma V4, V7, V8, V9 (L1, L2)
 - Sampling frequencies
 - MP3: 32 kHz, 44.1 kHz, 48 kHz
 - WMA: 44.1 kHz, 48 kHz
 - Bitrates
 - MP3: 8-320 kbps and variable bitrates
 - WMA: 64-192 kbps and variable bitrates
 - ID3 tag
 - v2.0 or later
 - Maximum number of albums/folders: 99
 - Maximum number of tracks/files: 999
 - Maximum level of directory: 8

- Unsupported formats
 - AAC, WAV, PCM audio files
 - DRM protected WMA files (.wav, .m4a, .m4p, .mp4, .aac)
 - WMA files in Lossless format
- Android-powered phones
 - Android version: V2.2 or above
 - Bluetooth version: V2.1 or above
 - Charging through the micro USB connector/socket
 - Width: between 52 mm and 73 mm

What's in the box



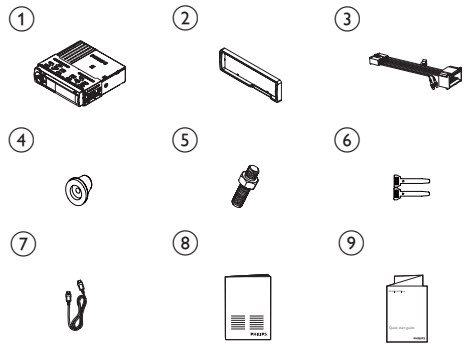

Check and identify the contents of the package:



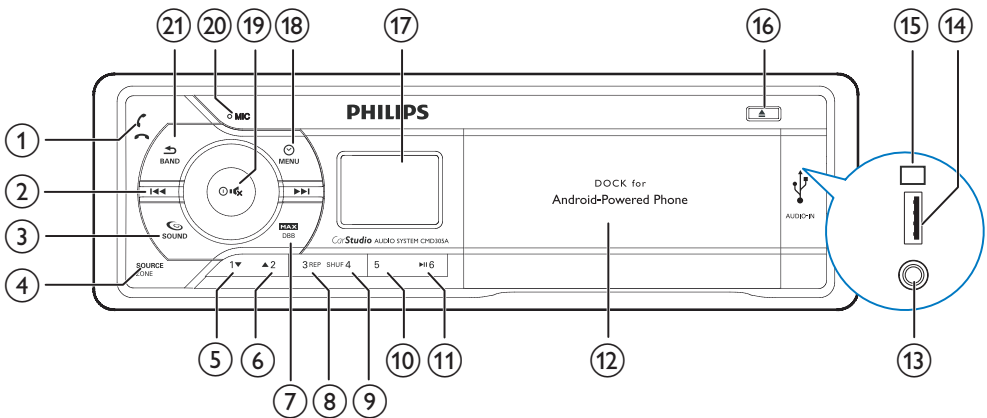

1	Main unit and front panel (with a sleeve)	2	Trim plate
3	ISO standard connector	4	Rubber cushion
5	1 x Screw	6	2 x Disassembly tools
7	USB cable	8	User manual
9	Quick start guide		

Overview of the system



- ① 
- Press to answer or redial a call.
 - Press to hang up a call.
- ② 
- Tune to a radio station.
 - Press to skip to the previous track.
 - Press and hold to rewind a track.
- ③  **SOUND**
- Press to enable or disable the full sound.
 - Press and hold to access the sound setting menu.
- ④ **SOURCE ZONE**
- Press repeatedly to select a source.
 - Press and hold to activate the selection of listening zones.
- ⑤  **1**
- In radio mode, press to select the preset radio station of No. 1.
 - In radio mode, press and hold to store the current radio station at channel No. 1.
 - For .wma/.mp3 tracks, press to select the next album/folder.

- ⑥  **2**
- In radio mode, press to select the preset radio station of No. 2.
 - In radio mode, press and hold to store the current radio station at channel No. 2.
 - For .wma/.mp3 tracks, press to select the previous album or folder.
- ⑦  **MAX DBB**
- Press to enable or disable the maximum volume.
 - Press and hold to enable or disable the DBB (dynamic bass boost) sound effect.
- ⑧ **3 REP**
- In radio mode, press to select the preset radio station of No. 3.
 - In radio mode, press and hold to store the current radio station at channel No. 3.
 - For tracks, press to select a repeat mode: repeat the current track, or repeat all tracks in the current album or folder.

⑨ **SHUF 4**

- In radio mode, press to select the preset radio station of No. 4.
- In radio mode, press and hold to store the current radio station at channel No. 4.
- For tracks, press to start playing all tracks in the current album or folder randomly.

⑩ **5**

- In radio mode, press to select the preset radio station of No. 5.
- In radio mode, press and hold to store the current radio station at channel No. 5.

⑪ **▶|| 6**

- In radio mode, press to select the preset radio station of No. 6.
- In radio mode, press and hold to store the current radio station at channel No. 6.
- Start, pause, or resume the play of tracks.

⑫ **Dock for Android-powered phone**

⑬ **AUDIO-IN**

- Connect to the audio output socket (usually the headphone socket) of an external device.

⑭ **USB**

- Connect to a USB storage device.

⑮ **RESET**

- Press to reset the system to factory default settings.

⑯ **▲**

- Press to eject the dock bracket.

⑰ **LCD screen**

⑱ **MENU**

- Press once to display the system clock.
- Press and hold to access the system menu.

⑲ **⏻**

- Press to turn on the system.
- Press and hold to turn off the system.
- Press to mute the system or release it from mute status.
- Press to confirm an option.
- Rotate to switch between menu options.
- Rotate to adjust the volume level.

⑳ **MIC**

- Integrated microphone.

㉑ **BAND**

- Press to exit the current menu.
- Press repeatedly to select a tuner band.
- Press and hold to transfer a call.

3 Before use



Caution

- Use the controls only as stated in this user manual.

Always follow the instructions in this chapter in sequence.

If you contact Philips, you will be asked for the model number and serial number of your car audio system. The model number and serial number are on its bottom. Write the numbers here:

Model No.: _____

Serial No.: _____

Install the car audio system

These instructions are for a typical installation. However, if your car has different requirements, make the adjustment accordingly. If you have any question regarding installation kits, consult your local retailer.



Caution

- This system is designed for negative ground (earth) 12V DC operation only.
- Always install this system in the car dashboard. Other locations can be dangerous as the rear of the system heats up during use.
- To avoid short-circuit: before you connect, make sure that the ignition is off.
- Make sure that you connect the yellow and red power supply leads after all other leads are connected.
- Make sure that all loose leads are insulated with electrical tape.
- Make sure that the leads do not get caught under screws iron parts that will move (e.g. seat rail).
- Make sure that all ground (earth) leads are run to a common ground (earth) point.
- Use only the supplied mounting hardware for a safe and secure installation.
- Improper fuses can cause damage or fire. When you need to change the fuse, consult a professional.
- When you connect other devices to this system, make sure that the rating of the car circuit is higher than the total fuse value of all the connected devices.
- Never connect speaker wires to the metal body or chassis of the car.
- Never connect speaker wires with stripes to one another.

Connect wires



Caution

- Make sure that all loose leads are insulated with electrical tape.

1 Check the car's wiring carefully, and then connect them to the supplied ISO wires.

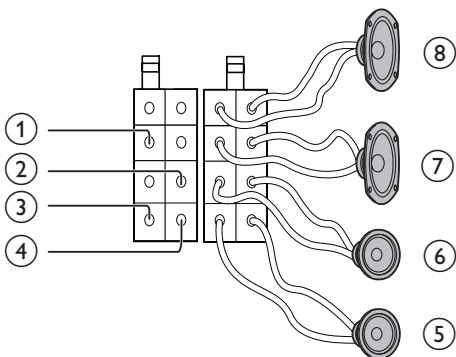

Connector	Connect to
1 Yellow wire	The +12V car battery which is live at all times
2 Blue/White wire	The electric antenna control lead or power supply lead of the antenna booster. If there is no electric antenna or antenna booster, or it is manually operated telescopic antenna, it is unnecessary to connect this lead.
3 Black wire	A metal surface of the car: Connect the black ground (earth) lead before connecting the yellow and red power supply leads.
4 Red wire	The +12V power terminal which is live in the accessory (ACC) position of the ignition switch. If there is no accessory position, connect to the +12V car battery terminal that is always live. Make sure that the black ground (earth) lead is connected to a metal surface of the car first.
5 Green and green/black wires	Left speaker (rear)
6 White and white/black wires	Left speaker (front)
7 Gray and gray/black wires	Right speaker (front)
8 Purple and purple/black wires	Right speaker (rear)

- 2 Connect the other end of the supplied standard connector to the car audio system.

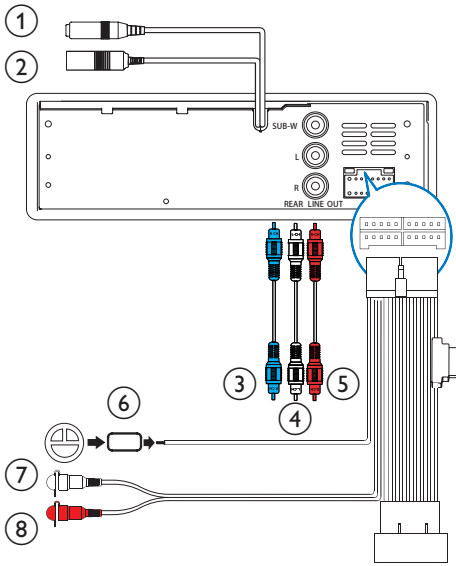

Connector	Connect to
1 ANTENNA	Antenna for radio
2 External Mic	An external microphone for phone call
3 SUBWOOFER (Socket)	Subwoofer
4 REAR LINE OUT L (Socket)	Rear left speaker
5 REAR LINE OUT R (Socket)	Rear right speaker
6 OE REMOTE (Brown)	OE remote
7 FRONT LINE OUT L	Front left speaker
8 FRONT LINE OUT R	Front right speaker



Tip

- The pin arrangement for the ISO connectors depends on the type of vehicle you drive. Be sure to make proper connections to prevent damage to the system.

Mount into the dashboard

- If the car does not have an on-board drive or navigation computer, disconnect the negative terminal of the car battery.
 - If you disconnect the car battery in a car that has an on-board drive or navigation computer, the computer may lose its memory.
 - If the car battery is not disconnected, to avoid short-circuit, make sure that the bare wires do not touch each other.
- Make sure that the car dashboard opening is within these measurements.

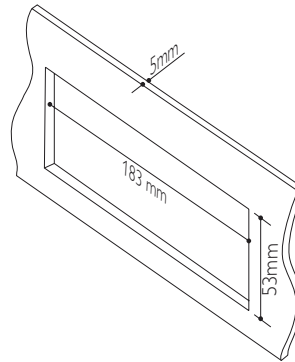

- Install the sleeve into the dashboard and bend the tabs outward to fix the sleeve.

Note

- If the system is not fixed by sleeve but by the supplied screws, skip this step.

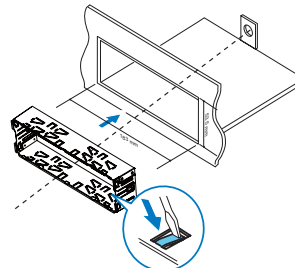

- 4 Place the supplied rubber cushion over the end of the mounting bolt.

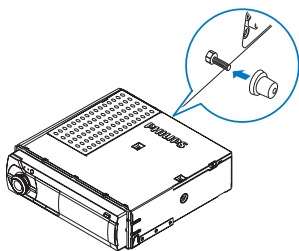

- 5 Slide the system into the sleeve until you hear a "click".

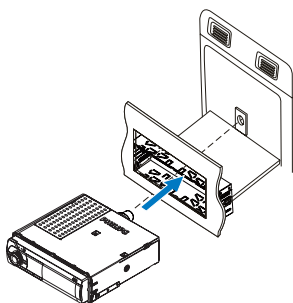

- 6 Attach the trim plate.

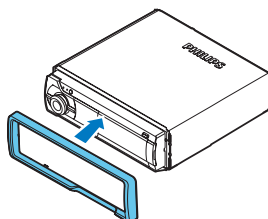

- 7 Reconnect the negative terminal of the car battery.

4 Get started





Power on

Press .







↳ [WELCOME] scrolls.

- To power off the system, press and hold  until [GOODBYE] is displayed.



Change system settings

- 1 Press and hold  to access the system menu.
- 2 Press  repeatedly to select an option.
 - [BT RECON]/[DISCONNECTED]
 - [RDS]
 - [PTY >]
 - [RDS AF]
 - [RDS TA]
 - [TP STORE]
 - [RDS REG]
 - [RDS CT]
 - [STORE >]
 - [AREA]
 - [LOCAL]
 - [CLOCK]
 - [CLOCK 12H]
 - [BEEP]
 - [BKO]
 - [DIMMER]
 - [DEMO]
- 3 Rotate  to select a setting.
 - To exit the setting, press .

Set the clock

- 1 Press and hold  to access the system menu.
- 2 Press  repeatedly until **[CLOCK]** and the current time are displayed.
↳ If the clock is not set before, **[--:--]** is displayed.
- 3 Rotate  to set the hour.
- 4 Press  to confirm.
- 5 Rotate  to set the minute.
- 6 Press  to confirm.

Set the clock format

- 1 Press and hold  to access the system menu.
- 2 Press  repeatedly until **[CLOCK 12H]** or **[CLOCK 24H]** is displayed.
- 3 Rotate  to select a setting.
 - **[CLOCK 12H]**: 12-hour time format
 - **[CLOCK 24H]**: 24-hour time format

Display the clock

- Press  to display the clock.
- To exit, press any button.

Select a source



Note

- When all other sources are unavailable, the system switches the source to **[RADIO]** automatically.



Press  repeatedly to select a source.

- **[RADIO]**: FM/MW radio
- **[AUDIO-IN]**: the audio that is transferred through the **AUDIO-IN** socket
- **[BT AUDIO]**: the audio that is transferred from a Bluetooth device
- **[USB]**: When a USB storage device is connected and recognized, you can select this source to play audio files that are stored on it.

5 Listen to radio



Select a radio region

You can select a radio region that matches your location.









- 1 Press and hold  to access the system menu.
- 2 Press  repeatedly until **[AREA]** is displayed.
- 3 Rotate  to select an option.
 - **[USA]** (United States)
 - **[EUR]** (Western Europe)
 - **[RUS]** (Russia)
 - **[AUS]** (Australia)
 - **[EAS]** (Middle East)
 - **[ASI]** (Asia Pacific)
 - **[JAP]** (Japan)
 - **[LAT]** (Latin America)

Select a tuner sensitivity

To receive stations with strong signals only or more radio stations, you can change the tuner sensitivity.

- 1 Press and hold  to access the system menu.
- 2 Press  repeatedly until **[LOCAL]** is displayed.
- 3 Rotate  to select a setting.
 - **[LOCAL ON]** (local on): Search for stations with strong signals only.
 - **[LOCAL OFF]** (local off): Search for stations with strong and weak signals.

Tune to a radio station

- 1 Press  repeatedly to switch the source to **[RADIO]**.
- 2 Press  repeatedly to select a band: **[FM1]**, **[FM2]**, **[FM3]**, **[MW1]** or **[MW2]**.
- 3 Press and hold  or  until the frequency digits blink.
- 4 Press  or  repeatedly to tune to a radio station manually.
 - ↳ The radio station is broadcast.
 - To search for a radio station automatically, press  or .



Store radio stations in memory



Note

- You can store a maximum of six stations in each band.

Store stations automatically

- 1 Press and hold  to access the system menu.
- 2 Press  repeatedly until **[STORE >]** is displayed.
- 3 Press  to confirm.
 - ↳ The strongest stations of the selected band are saved in preset channels automatically.

Store stations manually

- 1 Press  repeatedly to select a band.
- 2 Tune to a radio station that you want to store.
- 3 Press and hold a numeric button for three seconds.
 - ↳ The station is saved in the selected channel.
- 4 Repeat steps 2 and 3 to store more radio stations.
 - To replace a radio station, store another one in its channel.

Tune to a preset station

- 1 Press  repeatedly to select a band.
- 2 Press a numeric key to select a preset station.

Play with RDS





The RDS (Radio Data System) function operates only in areas with FM stations broadcasting RDS signals. If you tune to an RDS station, the station name is displayed.

Enable the RDS function







Note

- The RDS function is enabled by default.

- 1 Press and hold  to access the system menu.
- 2 Press  repeatedly until **[RDS]** is displayed.
- 3 Rotate  to select **[RDS ON]**.
 - ↳ The RDS function is enabled.
 - To disable the RDS function, rotate  to select **[RDS OFF]**.

Select a program type



Before tuning to RDS stations, you can select a program type to search for programs of the selected category only.

- 1 Press and hold  to access the system menu.
- 2 Press  repeatedly until **[PTY >]** is displayed.
- 3 Press  to confirm.
- 4 Rotate  to select a program type, and then press  to confirm.

Item	Program type	Description
1	NEWS	News services
2	AFFAIRS	Politics and current affairs
3	INFO	Special information programs
4	SPORT	Sports
5	EDUCATE	Education and advanced training
6	DRAMA	Radio plays and literature
7	CULTURE	Culture, religion and society
8	SCIENCE	Science
9	VARIED	Entertainment programs
10	POP M	Pop music
11	ROCK M	Rock music
12	EASY M	Light music
13	LIGHT M	Light classical music
14	CLASSICS	Classical music
15	OTHER M	Special music programs
16	WEATHER	Weather
17	FINANCE	Finance
18	CHILDREN	Children's programs
19	SOCIAL	Social Affairs
20	RELIGION	Religion
21	PHONE IN	Phone In
22	TRAVEL	Travel
23	LEISURE	Leisure
24	JAZZ	Jazz Music
25	COUNTRY	Country Music
26	NATION M	National Music
27	OLDIES	Oldies Music
28	FOLK M	Folk Music
29	DOCUMENT	Documentary
30	TEST	Alarm Test
31	ALARM	Alarm

Use alternate frequencies

If the signal of an RDS station is poor, enable the AF (Alternate Frequency) function to search for another station that transmits the same program.



- 1 Press and hold  to access the system menu.
- 2 Press  repeatedly until [RDS AF] is displayed.
- 3 Rotate  to select a setting:
 - [AF ON]: Enable the AF function.
 - [AF OFF]: Disable the AF function.

Set the region for AF tuning

You can set the region for AF tuning:



[REG ON] Only RDS stations in current region can be tuned to automatically.

[REG OFF] All RDS stations can be tuned to automatically.

- 1 Press and hold  to access the system menu.
- 2 Press  repeatedly until [RDS REG] is displayed.
- 3 Rotate  to select a setting.

Receive traffic announcement

If you do not want to miss traffic announcement, enable the TA (Traffic Announcement) function.

- 1 Press and hold  to access the system menu.
- 2 Press  repeatedly until [RDS TA] is displayed.
- 3 Rotate  to select a setting:
 - [TA ON]: When a traffic announcement is on air, the system automatically switches to the tuner mode and begins to broadcast the traffic announcement. When the traffic announcement is over, the system returns to the previous mode.
 - [TA OFF]: Traffic announcement does not cut in.





Tip

- When a traffic announcement cuts in, you can press  to switch the system to the previous mode.



Receive traffic programs only

If you want to receive traffic announcements only, use the TP (Traffic Program) function.

- 1 Press and hold  to access the system menu.
- 2 Press  repeatedly until [TP STORE] is displayed.
- 3 Press  to start searching for and storing stations that regularly broadcast traffic announcements.
 - ↳ After the search is complete, the first stored station starts broadcasting.

Synchronize the system clock

You can synchronize the system clock with an RDS station that transmits time signals.

- 1 Press and hold  to access the system menu.
- 2 Press  repeatedly until [RDS CT] is displayed.
- 3 Rotate  to select a setting:
 - [CT ON]: Synchronize the system clock with the RDS station.
 - [CT OFF]: Do not synchronize the system clock.



Tip

- The accuracy of time depends on the RDS station that transmits the time signal.

6 Use Bluetooth devices

With this car audio system, you can listen to audio from a player or make a call through Bluetooth.

Pair a device



Note

- Philips does not guarantee the compatibility with all Bluetooth devices.
- Before pairing a device with this system, read its user manual for Bluetooth compatibility. Make sure that the Bluetooth firmware version of the device is V2.1 or later.
- Make sure that Bluetooth function is enabled on your device, and your device is set as visible to all other Bluetooth devices.
- The operational range between this system and a Bluetooth device is approximately 3 meters (10 feet).
- Any obstacle between this system and a Bluetooth device can reduce the operational range.
- Keep away from any other electronic device that may cause interference.

On your device, follow the steps below.

- 1 Enable it to search for other Bluetooth devices.
- 2 In the device list, select **CMD305A**.
- 3 Enter the default password "0000".
 - ↳ If the pairing is successful, [PAIR OK] is displayed.
 - To disconnect the device, disable the Bluetooth feature on it.

Disconnect a device



- 1 Press and hold  until [BT DISCO] is displayed.
- 2 Press  to confirm.
 - ↳ [DISCONNECTED] scrolls.



Tip





- You can also disable the Bluetooth function on this connected device.

Reconnect a device

- 1 Press and hold  until **[BT RECON]** is displayed.
- 2 Press  to confirm.
 - If the auto connection between CMD305A and this device is authorized, CMD305A reconnects to this device automatically. If not, perform step 3.
- 3 On this device, accept the connection request from CMD305A.
 - ↳ **[CONNECTED]** scrolls.

Play audio from a connected device

If the connected Bluetooth device supports Advanced Audio Distribution Profile (A2DP), you can listen to tracks that are stored on the device through the system. If the device also supports Audio Video Remote Control Profile (AVRCP) profile, you can control play on the system.

- 1 Connect the Bluetooth device to this system via Bluetooth.
- 2 Press  repeatedly to switch the source to **[BT AUDIO]**.
 - ↳ Play starts automatically.
 - If play does not start, press  **6**.
 - To pause play, press  **6** again.
 - To skip to the previous or next track, press .



Note

- If the connected device does not support the AVRCP profile, control play on the connected device.

Make a call





Note

- Keep the Bluetooth connection active between the system and your mobile.

Call a number

On your mobile, call a number:
↳ **[CALL---** is displayed.

Redial the last called number

- 1 Press 
 - ↳ **[REDIAL]** is displayed.
- 2 Press  to confirm.
 - ↳ **[CALL---** is displayed.

Pick up an incoming call

When the system receives an incoming call, the phone number or **[PHONE IN]** is displayed. Press  to answer the call.

Reject an incoming call

Press and hold  until **[END]** is displayed.

End a call

To end an on-going call, press .

Transfer a phone call to mobile phone

By default, voice comes from the loudspeakers during a call.

- 1 Press and hold  until **[TRANSFER]** is displayed.
 - ↳ The loudspeakers are muted, and the voice comes from your mobile phone only.
- 2 Take up your mobile phone for the conversation.

7 Play from a USB storage device

This system can play .mp3 and .wma files that are copied onto a compatible USB storage device.



Note

- Philips does not guarantee compatibility with all USB storage devices.
- NTFS (New Technology File System) file system is not supported.

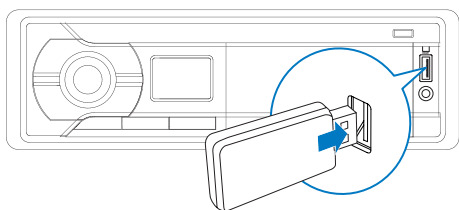

- 1 Connect the USB storage device to the  socket.
- 2 Press **SOURCE ZONE** repeatedly until **[USB]** is displayed.
↳ Play starts automatically.

If play does not start automatically,

- 1 Press **1▼ / ▲2** to select a folder.
- 2 Press **◀◀ / ▶▶** to select a file.
- 3 Press **▶▶ 6** to start play.

Control play

During play, follow the instructions below to control play.

Buttons	Functions
▶▶ 6	Pause or resume play.
◀◀ / ▶▶	Skip to the previous or next track. Press and hold to rewind a track or search forward fast within a track.
1▼ / ▲2	Skip to the previous or next folder when one or more folders exist.
3 REP	Select a repeat mode. <ul style="list-style-type: none">• [REPEAT TRACK]: repeat the current track• [REPEAT ALL]: repeat all tracks• [REPEAT FOLDER]: repeat all tracks in the current folder
SHUF 4	Enable or disable shuffle play. <ul style="list-style-type: none">• [SHUF FOLDER]: play all tracks in the current folder randomly• [SHUF ALL]: play all tracks randomly• [SHUF OFF]: play tracks in sequence

8 Listen to an external device

You can use the system to amplify the audio input that is transferred from an external device, for example, MP3 player:

- 1 Press **SOURCE**/**ZONE** repeatedly to switch the source to **[AUDIO-IN]**.
- 2 Connect the MP3 link cable to
 - the **AUDIO-IN** socket on the system, and
 - the audio output socket (usually the headphone socket) on the external device.
- 3 Play audio on the external device (refer to its user manual).

9 Use the dock

An application **Philips CarStudio** is available on Google Play for this car audio system. To enjoy full features, download and install the application to your Android-powered phone.

Compatible with Android™

Before using the dock, check your Android-powered phone and make sure that it meets the following requirements:

- With Android operating system V2.2 or later;
- With a micro USB socket, and
- With a width between 52 mm and 73 mm.

For other Android-powered devices with a micro USB socket, you can use the dock to

- Charge your device through the USB socket.

Prepare for docking

- 1 Press **▲** to eject the dock bracket.

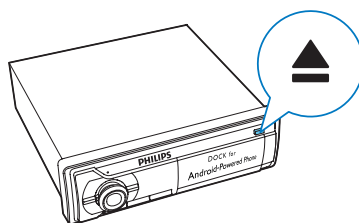

- 2 Pull out the dock bracket until you see the yellow lines and hear a "click".

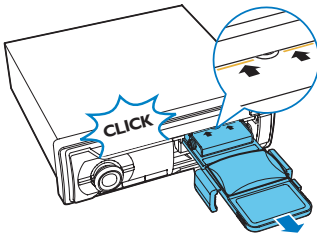

- 3 Flip the dock bracket upwards.

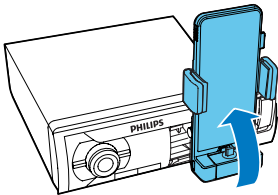

- 4 Press **RELEASE** to loosen the hooks.

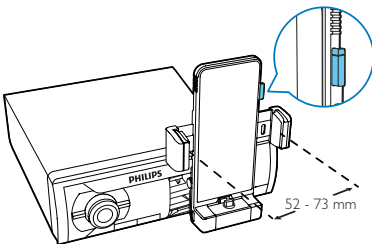

Connect your phone

You can connect your phone to the dock directly or through the supplied USB cable.

Dock your phone

Note

- Make sure that the width of your phone is between 52 mm and 73 mm.
- Before docking your phone, make sure that the dock bracket is in portrait position.

- 1 Flip out the USB connector or hide it in the dock.
- If the USB socket of your phone is on its bottom, flip out the USB connector.
 - Otherwise, flip the USB connector inwards to hide it in the dock.

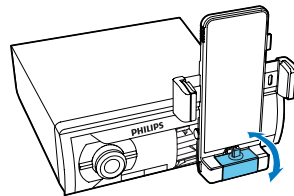

- 2 Switch the cushions to make sure that no buttons on the side of the phone are to be covered.

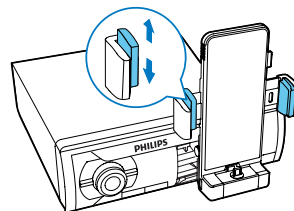

- 3 Connect your phone to the dock with its screen facing you.
- To match the USB socket of your phone, turn the USB connector by 180° as illustrated if necessary.

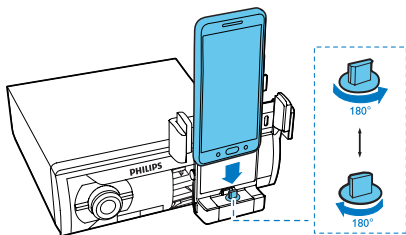

- 4 Pinch the hooks to secure your phone.

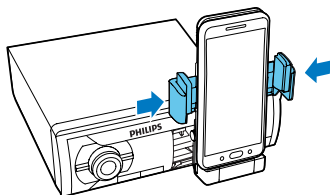

Use the USB cable

If the USB socket of your phone is not on its bottom or the width of your phone exceeds the range from 52 mm to 73 mm, use the supplied USB cable for connection.

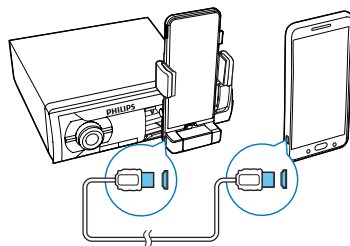
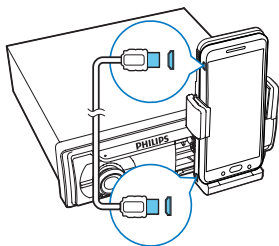

- Connect the USB cable between
- the USB socket of your phone, and
 - the USB socket in the dock.

Adjust the dock bracket



Caution

- When the dock bracket is in portrait position, do not turn it clockwise.
- When the dock bracket is in landscape position, do not turn it anti-clockwise.

Switch to landscape mode

- 1 Turn the dock bracket anti-clockwise by 90 degrees.

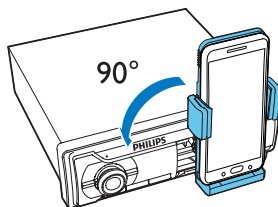

- 2 Adjust the viewing angle.

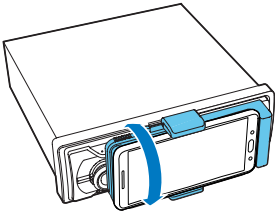

Switch to portrait mode

- 1 Turn the dock bracket clockwise by 90 degrees.

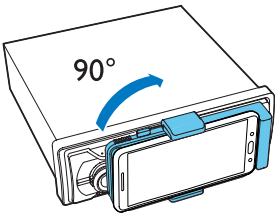

- 2 Adjust the viewing angle.

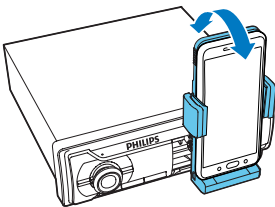

Install the CarStudio application



Note

- Make sure that the internet connection is active on your phone.

- 1 Run the Google **Play Store** application on your phone.

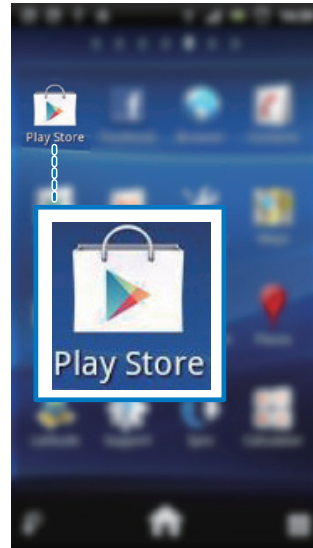

- 2 Tap **Q** to display the search interface.

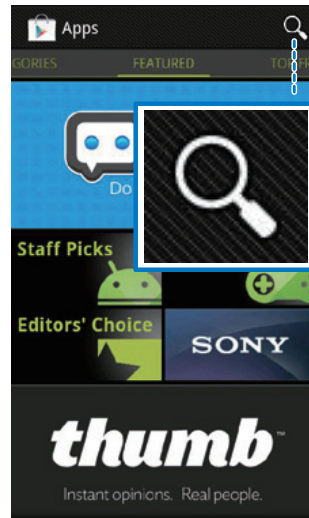

3 Type in **CarStudio** and then tap **Search**.

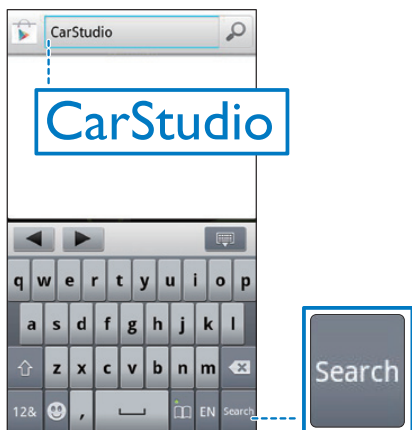

4 Tap Philips **CarStudio** in the search result list.

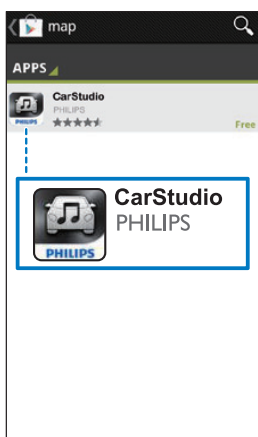

5 Tap **Install** and then **Accept & download** to start the download and installation.

↳ After the download and installation is complete, the **CarStudio** icon is displayed in the list of applications.

Use the CarStudio application

Note

- To use the hands-free function or play audio through the dock, connect your phone with the car audio system via Bluetooth first.
- To enjoy the latest features, update the application on your phone when an update message prompts.
- After update, the interface and features may be different from the description in this section. Follow the actual operations.

1 Run the **CarStudio** application on your phone.

↳ The main interface is displayed.

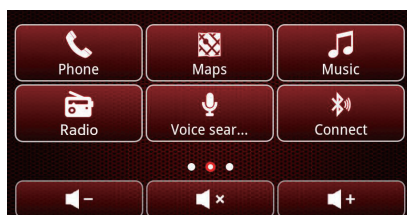
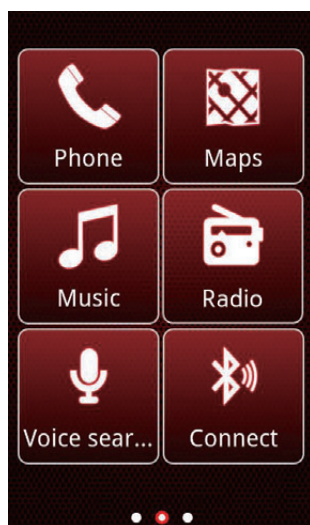

- To switch the interface for more features, swipe on the screen.

2 Tap an icon to access its feature or change settings.

- 📞 (phone): Make a phone call
- 🗺️ (map): Run the map application that is installed on your phone.
- 🎵 (music): Play music
- 📻 (radio): Listen to radio
- 🗣️ (Voice Search): Run the Voice Search application that is installed on your phone.
- 📶 / 📶× (Bluetooth connection): Search for Bluetooth devices or break the current connection.
- 🎧 (external audio input): Switch the source to the audio input that is transferred through the **AUDIO-IN** socket.
- 🔄 (USB): Switch the source to USB storage device.
- ⚙️ (settings): Change settings
- 🏠 : Return to the main interface
- + : Add a shortcut of an application onto the current interface. Tap + to display the dialog box, tap **Application** on the dialog box to display all applications that are installed on your phone, and then tap an application name to create a shortcut.
- To remove an icon from the interface, tap and hold it until a dialog box is displayed, and then tap ✕.

Charge your phone

Once your phone is connected and recognized, the charging starts.

Undock your phone

Note

- Before you undock your phone, make sure that the dock bracket is in portrait position.

1 Press **RELEASE** to loosen the hooks.

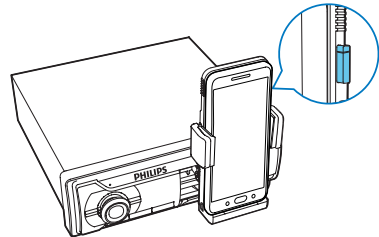

2 Slide up the phone to disconnect from the dock.

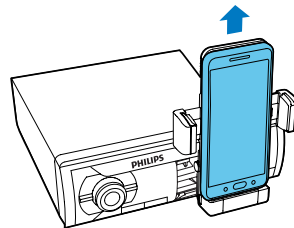

Tip

- For the safety of your property, undock your phone before leaving your car.

Store the dock bracket

Note

- Before storage, make sure that you have unloaded your phone and pinched the hooks.

- 1 Flip the dock bracket downwards until you hear a "click".
 - ↳ You can see the indication line on top of the dock panel. If not, pull the dock panel outwards until you see it.

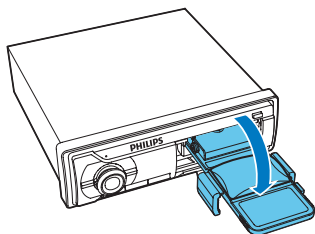

- 2 Push the dock panel inwards until you hear a "click".

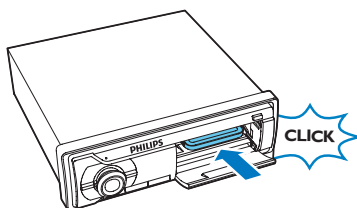

- 3 Flip up the cover:

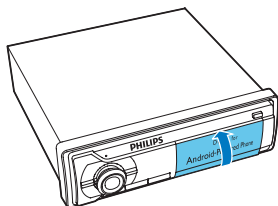

10 Adjust sound

The following operations are applicable to all compatible media.

Adjust the volume level

Rotate  clockwise or anti-clockwise.

Mute sound

Press .

- To restore sound, press  again.

Use the DBB sound effect

Press and hold  until one of the following settings is displayed.



- [DBB ON]: Dynamic bass boost (DBB) is enabled.
- [DBB OFF]: DBB is disabled.

Enable the max sound

Press  repeatedly to select one of the following settings.

- [MAX ON]: Use the maximum sound.
- [MAX OFF]: Return to the customized sound.

Select a listening zone



- 1 Press and hold  until one of the following settings is displayed.
 - [ALL]: For all passengers
 - [FRONT-L]: For the front-left seat only
 - [FRONT-R]: For the front-right seat only
 - [FRONT]: For front passengers only
- 2 Rotate  to select a setting.

Enable the full-range sound



Press  repeatedly to select one of the following settings.

- **[FULL ON]**: Enable the full-range sound
- **[FULL OFF]**: Use the preset equalizer that you select



Select a preset sound equalizer

- 1 Press and hold  until **[EQ]** and the name of current equalizer are displayed.
- 2 Rotate  to select one of the preset sound equalizers.
 - **[FLAT]** (flat)
 - **[POP]** (pop)
 - **[ROCK]** (rock)
 - **[JAZZ]** (jazz)
 - **[CLASSIC]** (classic)
 - **[TECHNO]** (techno)
 - **[OPTIMAL]** (optimal)
 - **[USER]** (user settings)

Other sound settings

- 1 Press and hold  until **[EQ]** is displayed.
- 2 Press  repeatedly to select a setting.
 - **[BALANCE]**: Balance of sound from left and right speakers (12L to 12R)
 - **[FADER]**: Fade of sound from front and rear speakers (12R to 12F)
 - **[BASS]**: Bass level (-7 to +7)
 - **[TREBLE]**: Treble level (-7 to +7)
 - **[SUBW]**: Enable or mute the subwoofer
- 3 Rotate  clockwise or anti-clockwise to change the setting.

11 Adjust system settings

- 1 Press and hold  to access the system menu.
- 2 Press  repeatedly until one of the following settings is displayed.
 - [BEEP], [BKO], [DIMMER], or [DEMO]
- 3 Rotate  to change the setting.

[BEEP]	[BEEP ON]	Enable the beep sound of buttons.
	[BEEP OFF]	Disable the beep sound of buttons.
[BKO]	[BKO 10S]	Turn off the screen automatically 10 seconds after the last operation.
	[BKO 20S]	Turn off the screen automatically 20 seconds after the last operation.
	[BKO OFF]	Never turn off the screen automatically.
[DIMMER]	[DIMMER HIGH]	Increase the brightness level of the screen.
	[DIMMER LOW]	Decrease the brightness level of the screen.
[DEMO]	[DEMO ON]	Demonstrate all features after the system stays inactive for 120 seconds.
	[DEMO OFF]	Disable the demo mode.

12 Additional information

Reset the system

You can reset the system to factory default settings.

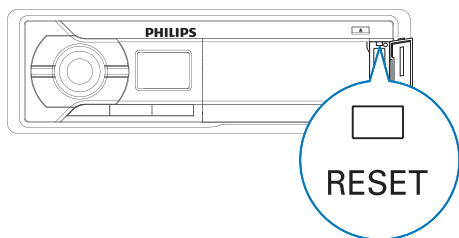

- 1 Open the protective cover for the USB socket, MP3-LINK socket, and **RESET** button.
- 2 Press **RESET** with the tip of a ball-point pen or toothpick.
↳ The system is reset.

Replace the fuse

If there is no power, check the fuse and replace it if it is damaged.

- 1 Detach the system from dashboard.
- 2 Check the electric connection.
- 3 Remove the damaged fuse from the rear panel.
- 4 Insert a new fuse with the same specifications (15 A).

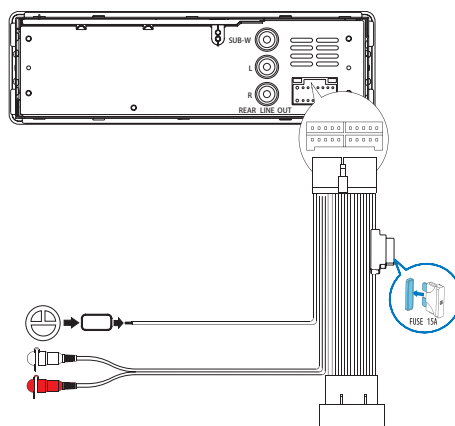

Note

- If the fuse gets damaged immediately after it is replaced, an internal malfunction may occur. In this case, consult your Philips retailer.

13 Product information

Frequency band	2.4000 GHz - 2.4835 GHz ISM Band
Range	3 meters (10 feet in free space)
Standard	V2.0



Note

- Product information is subject to change without prior notice.

General

Power supply	12 V DC (11V - 16V), negative ground
Fuse	15 A
Suitable speaker impedance	4-8 Ω
Maximum power output	50 W \times 4 channels
Continuous power output	22 W \times 4 RMS (4 Ω 10% T.H.D.)
Pre-Amp output voltage	2.5 V
Aux-in level	500 mV
Dimensions (W \times H \times D)	188 \times 58 \times 199.5 mm
Weight	1.32 kg

Radio

Frequency range - FM	87.5-108.0 MHz (100 kHz per step in auto search and 50 kHz per step in manual search)
Frequency range - AM(MW)	522-1620 kHz (9 kHz) 530-1710 kHz (10 kHz)
Usable sensitivity - FM	8 μ V
Usable sensitivity - AM(MW) (S/N = 20 dB)	30 μ V

Bluetooth

Output power	0 dBm (Class 2)
--------------	-----------------

14 Troubleshooting



Warning

- Never remove the casing of this product.

To keep the warranty valid, never try to repair the product yourself.

If you encounter problems when using this product, check the following points before requesting service. If the problem remains unsolved, go to the Philips Web page (www.philips.com/support). When you contact Philips, make sure that the product is nearby and the model number and serial number are available.

General

No power or no sound

- The power supply from car battery is cut off, or the car battery runs out of energy. Power the system with car battery.
- Car engine is not on. Turn the car engine on.
- Cable is not correctly connected. Check connections.
- Fuse is burnt. Replace fuse.
- Volume is too low. Adjust volume.
- If the above solutions cannot help, press the **RESET** button.
- Make sure that the current track is in a compatible format.

Noise in broadcasts

- Signals are too weak. Select other stations with stronger signals.
- Check the connection of the car antenna.
- Change the broadcast setting from stereo to mono.

Preset stations are lost.

- Battery cable is not correctly connected. Connect the battery cable to the terminal that is always live.

Display shows ERR-12.

- USB data error. Check the USB storage device.

GPS signal reception of the phone is poor.

- Remove the phone from the dock, and place it in another location for better signal reception.

About Bluetooth device

Cannot pair the Bluetooth enabled device with the car audio system.

- The device does not support the profiles required for the system.
- The Bluetooth function of the device is not enabled. Refer to the user manual of the device for how to enable the function.

The audio quality is poor after connection with a Bluetooth-enabled device.

- The microphone is not correctly positioned. Adjust the position of the microphone. For example, stick the microphone onto the dashboard where close to the driver.
- The Bluetooth reception is poor. Move the device closer to the car audio system or remove any obstacle between the device and the system.

Music playback is unavailable on the system even after successful Bluetooth connection.

- The device cannot be used with the system to play music.

The paired mobile phone connects and disconnects constantly.

- The Bluetooth reception is poor. Move the mobile phone closer to the car audio system or remove any obstacle between the mobile phone and the system.
- Some mobile phones may connect and disconnect constantly when you make or end calls. This does not indicate any malfunction of the system.

- For some mobile phones, the Bluetooth connection may be deactivated automatically as a power-saving feature. This does not indicate any malfunction of the system.

15 Notice

Any changes or modifications made to this device that are not expressly approved by Philips Consumer Lifestyle may void the user's authority to operate the equipment.

Compliance

CE 1177

This product complies with the radio interference requirements of the European Community.

Care of the environment



Your product is designed and manufactured with high quality materials and components, which can be recycled and reused.



When this crossed-out wheeled bin symbol is attached to a product it means that the product is covered by the European Directive 2002/96/EC. Please inform yourself about the local separate collection system for electrical and electronic products.

Please act according to your local rules and do not dispose of your old products with your normal household waste.

Correct disposal of your old product helps to prevent potential negative consequences for the environment and human health.

Environmental information

All unnecessary packaging has been omitted. We have tried to make the packaging easy to separate into three materials: cardboard (box), polystyrene foam (buffer) and polyethylene (bags, protective foam sheet.)

Your system consists of materials which can be recycled and reused if disassembled by a specialized company. Please observe the local regulations regarding the disposal of packaging materials, exhausted batteries and old equipment.

Copyright

2012 © Koninklijke Philips Electronics N.V. Specifications are subject to change without notice. Trademarks are the property of Koninklijke Philips Electronics N.V or their respective owners. Philips reserves the right to change products at any time without being obliged to adjust earlier supplies accordingly.

Trademark notice

The Bluetooth® word mark and logos are registered trademarks owned by Bluetooth SIG, Inc. and any use of such marks by Philips is under license.



Windows Media and the Windows logo are trademarks, or registered trademarks of Microsoft Corporation in the United States and/or other countries.

Android is a trademark of Google Inc. Use of this trademark is subject to Google permissions.

Other trademarks and trade names are those of their respective owners.



Specifications are subject to change without notice
© 2012 Koninklijke Philips Electronics N.V.
All rights reserved.

CMD305A_05_UM_V1.0

