

CIRCUIT DIAGRAM - MAIN BOARD
 RADIO PART

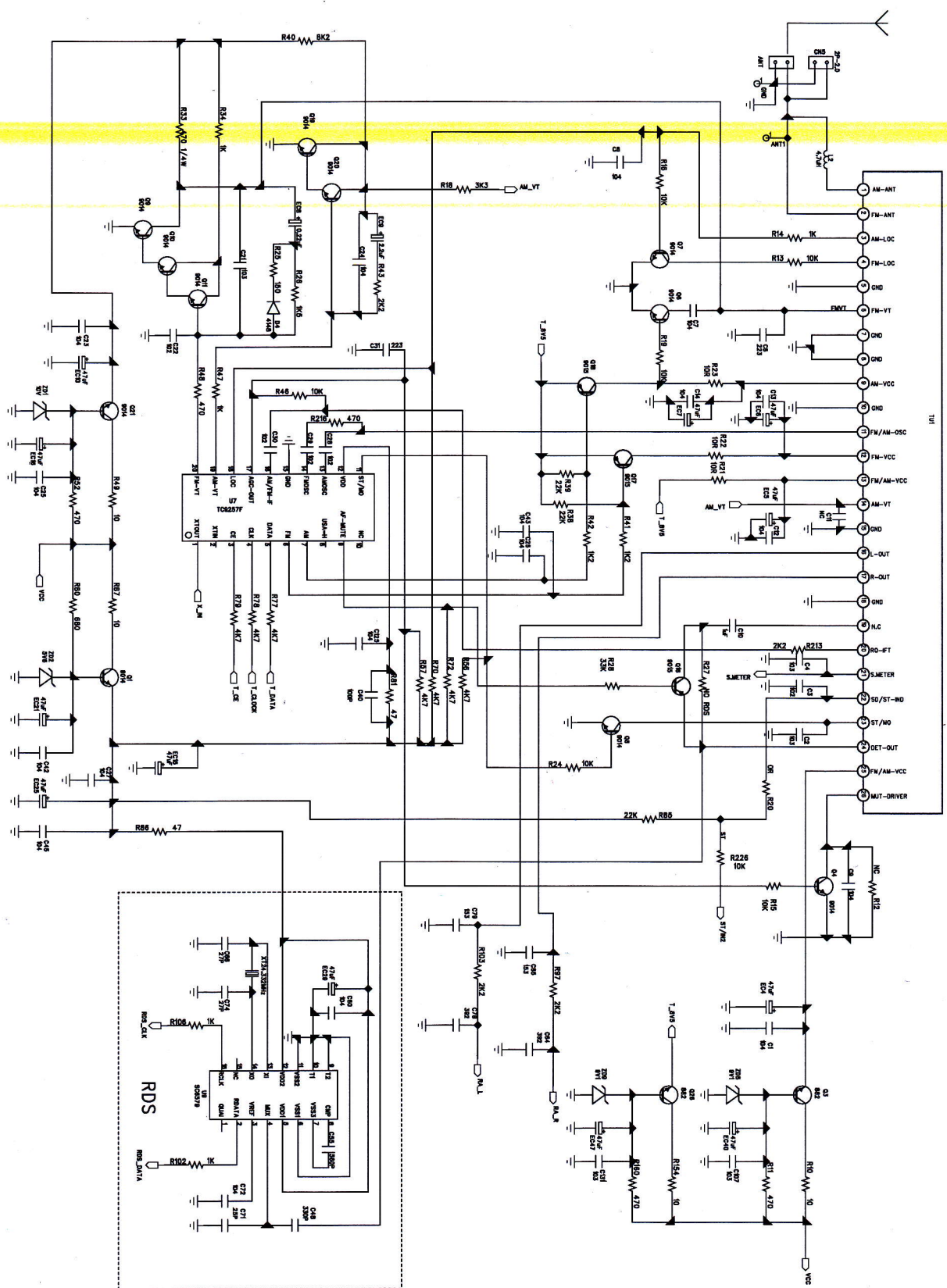

CIRCUIT DIAGRAM - MAIN BOARD
AUDIO PART

5-2

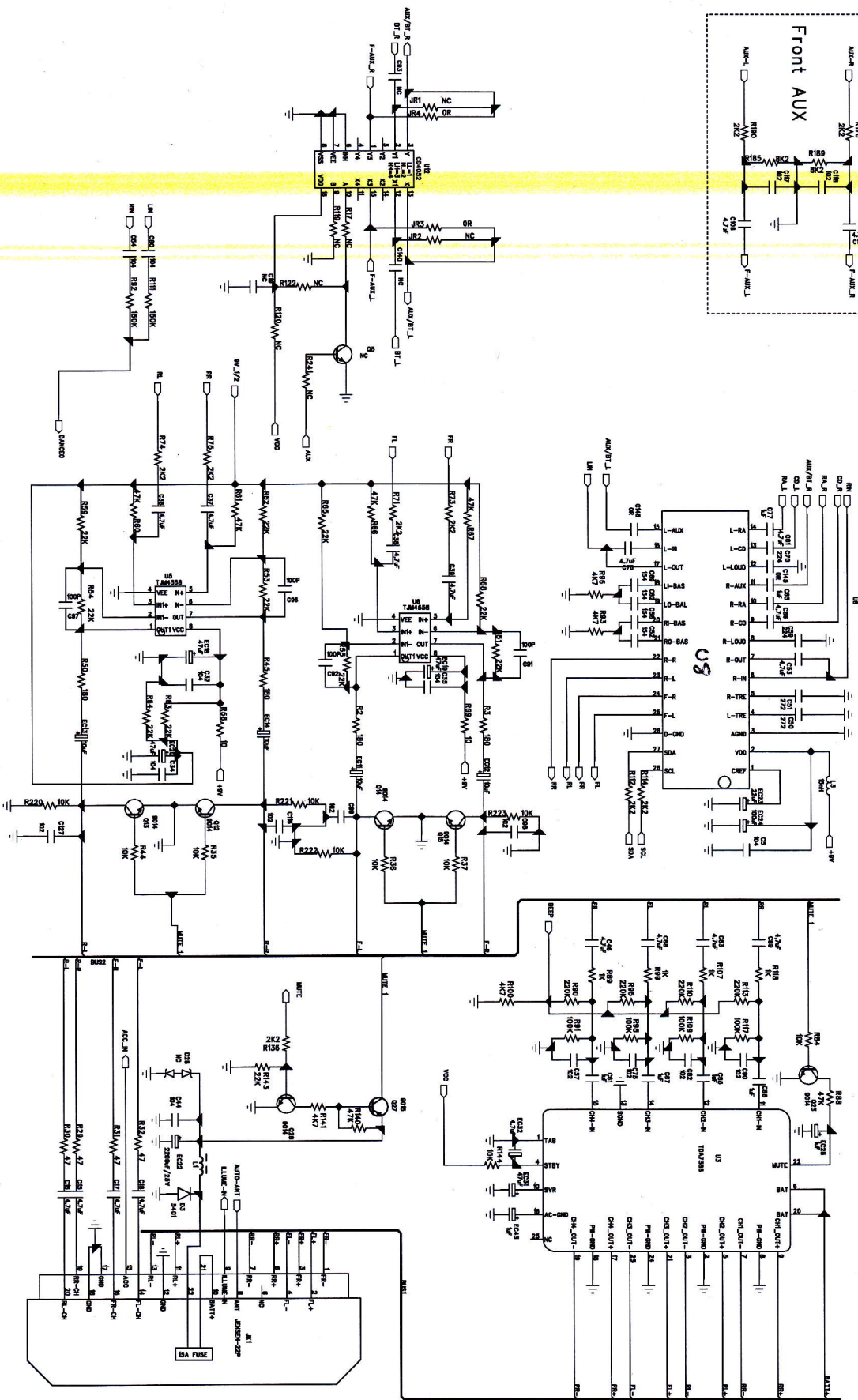
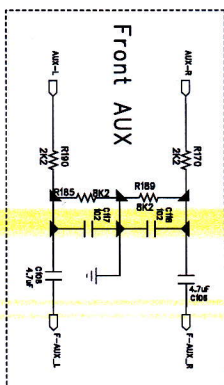

5-2

CIRCUIT DIAGRAM - MAIN BOARD
MCU PART

5 - 1

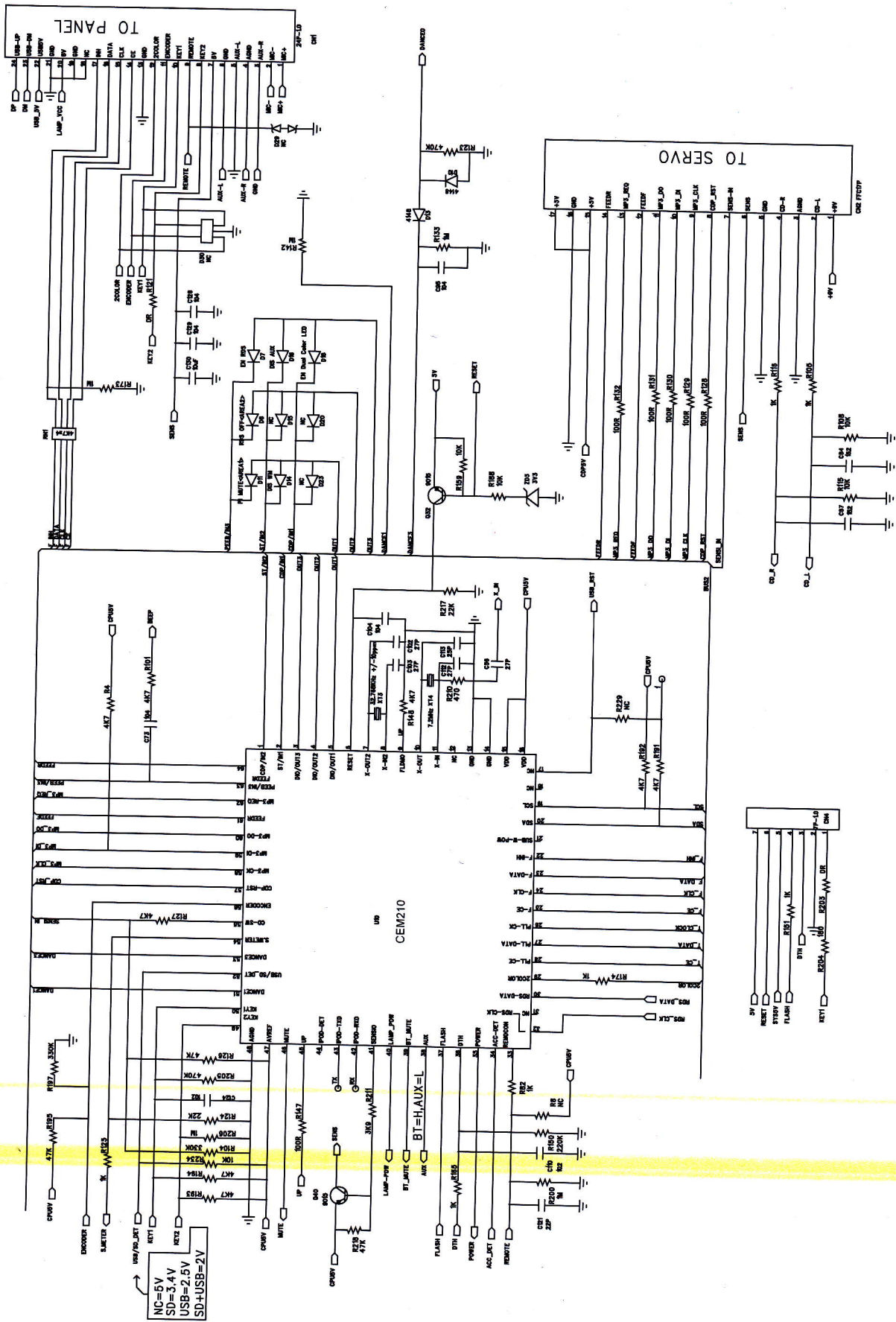

5 - 1

DISASSEMBLY DIAGRAM VIEW
PART 2

3. Front panel disassembly ;

Step:1

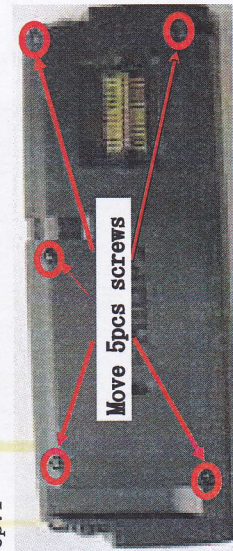

Step:2



Step:3

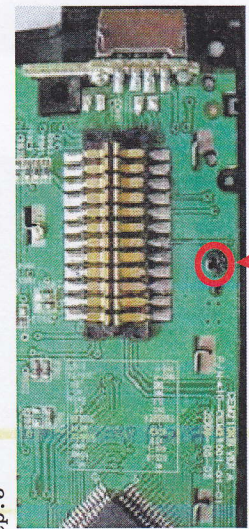

Step:4

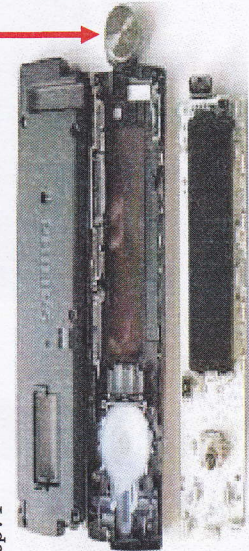

DISASSEMBLY DIAGRAM VIEW
PART 1

1. How to open Unit of top and button cover ?

Step:1

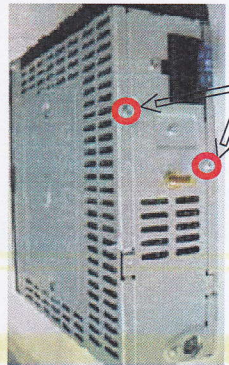

Remove 2 screws of top and button cover

Step:2

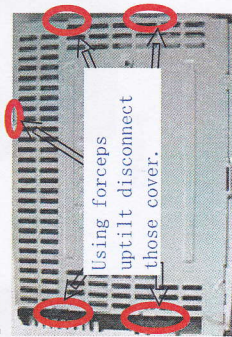

Using forceps
uptilt disconnect
those cover.

Step:3

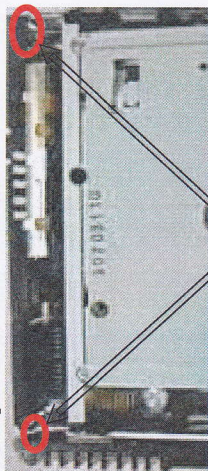

Remove 4 screws, the unit and CD loader was
Isolation

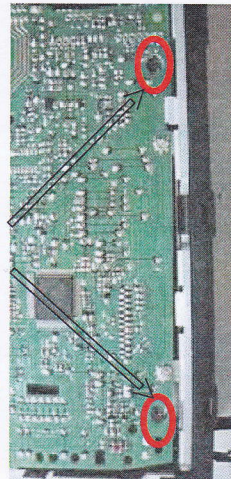

Remove 3pcs screws on servo board, then
the CD and servo PCBA isolation.

2. Servo board disassembly .

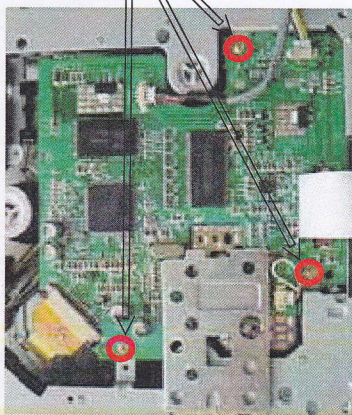

SET BLOCK DIAGRAM

4-1

4-1

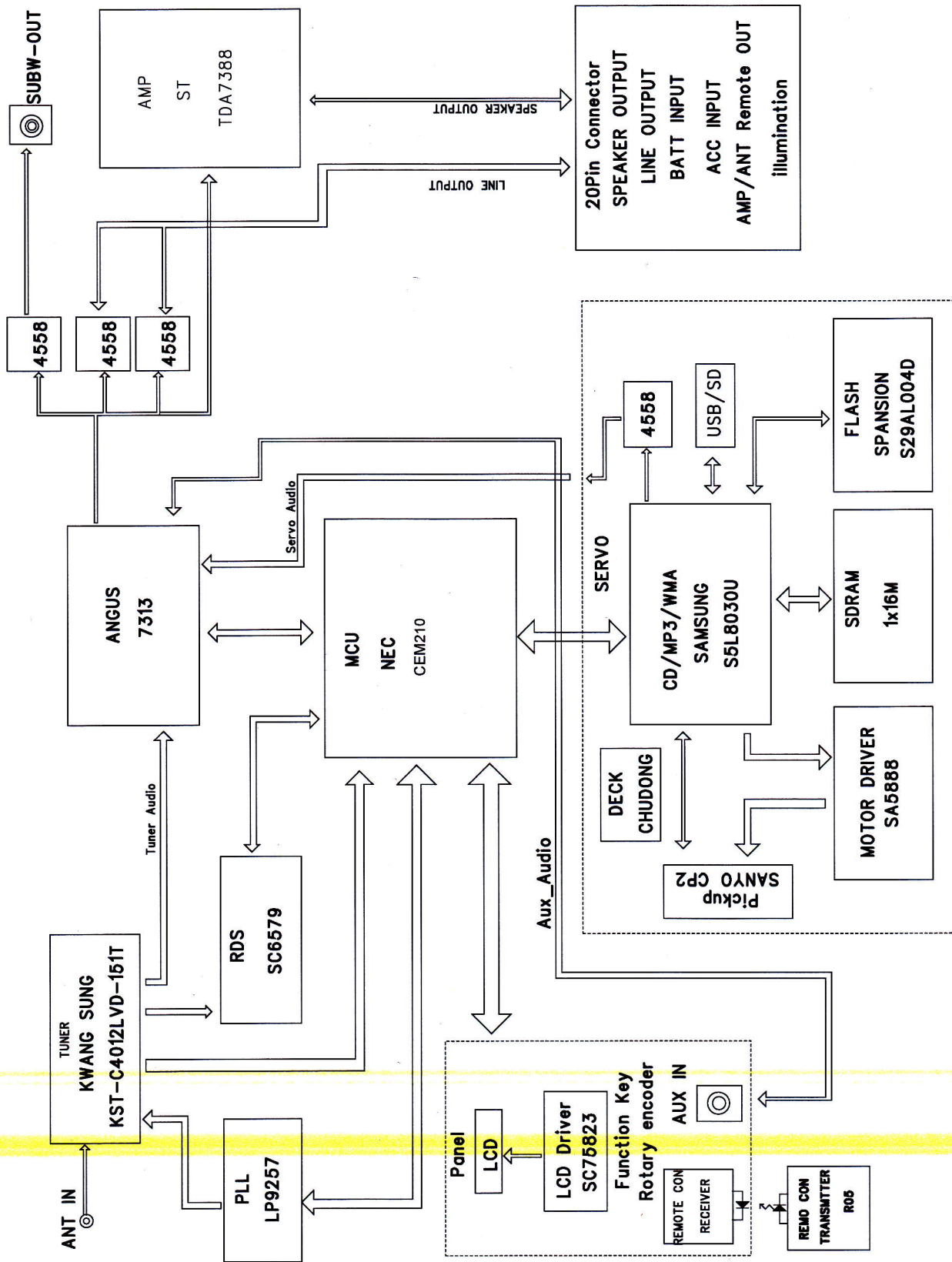

SET WIRING DIAGRAM

4-2

4-2

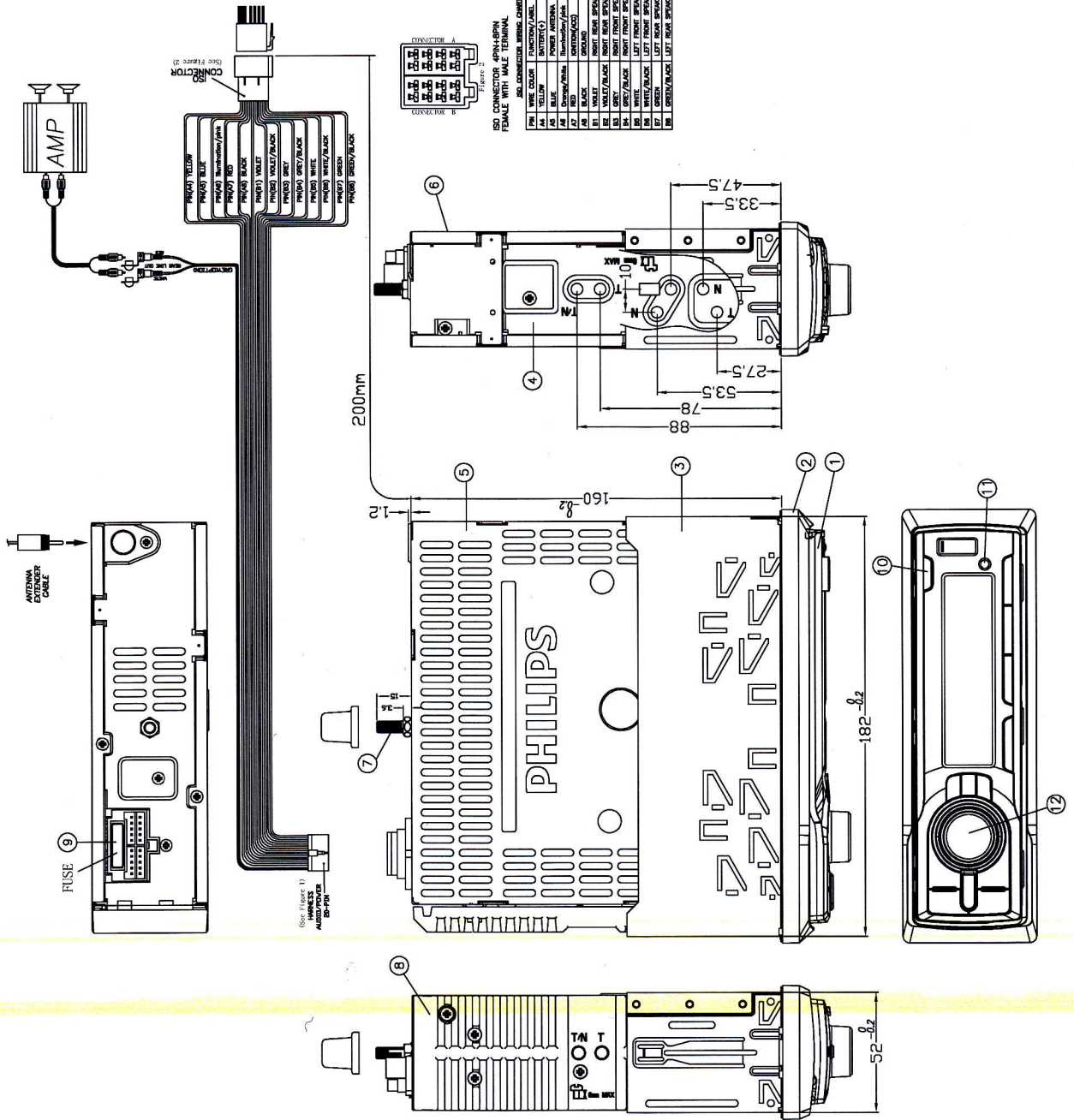

INSTRUCTIONS ON CD PLAYABILITY

PLAYABILITY CHECK

For sets which are compatible with CD-RW discs
 use CD-RW Printed Audio Disc.....7104 099 9661 1

TR 3 (Fingerprint)
 TR 8 (600µ Black dot) **maximum at 01:00**

• playback of these two tracks without audible disturbance
 playing time for: Fingerprint ≥ 10 seconds
 Black dot from 00:50 to 01:10

• Jump forward/backward (search) within a reasonable time

For all other sets
 use CD-DA SBC 444A.....4822 397 30245

TR 14 (600µ Black dot) **maximum at 01:15**
 TR 19 (Fingerprint)
 TR 10 (1000µ wedge)

• playback of all these tracks without audible disturbance
 playing time for: 1000µ wedge ≥ 10 seconds
 Fingerprint ≥ 10 seconds
 Black dot from 01:05 to 01:25

• Jump forward/backward (search) within a reasonable time

CUSTOMER INFORMATION

It is proposed to add an addendum sheet to the set which informs the customer that the set has been checked carefully - but no fault was found.
 The problem was obviously caused by a scratched, dirty or copy-protected CD. In case problems remain, the customer is requested to contact the workshop directly.
 The lens cleaning (method) should be mentioned in the addendum sheet.

The final wording in national language as well as the printing is under responsibility of the Regional Service Organizations.



The direction of cleaning must be in the way as indicated in the picture below.

The actuator is a very precise mechanical component and may not be damaged in order to guarantee its full function. Clean the lens gently (don't press too hard) with a soft and clean cotton bud moistened with the special lens cleaner.

Because the material of the lens is synthetic and coated with a special anti-reflectivity layer, cleaning must be done with a non-aggressive cleaning fluid. It is advised to use "Cleaning Solvent"

Before touching the lens it is advised to clean the surface of the lens by blowing clean air over it. This to avoid that little particles make scratches on the lens.

LIQUID LENS CLEANING

INSTRUCTIONS ON CD PLAYABILITY

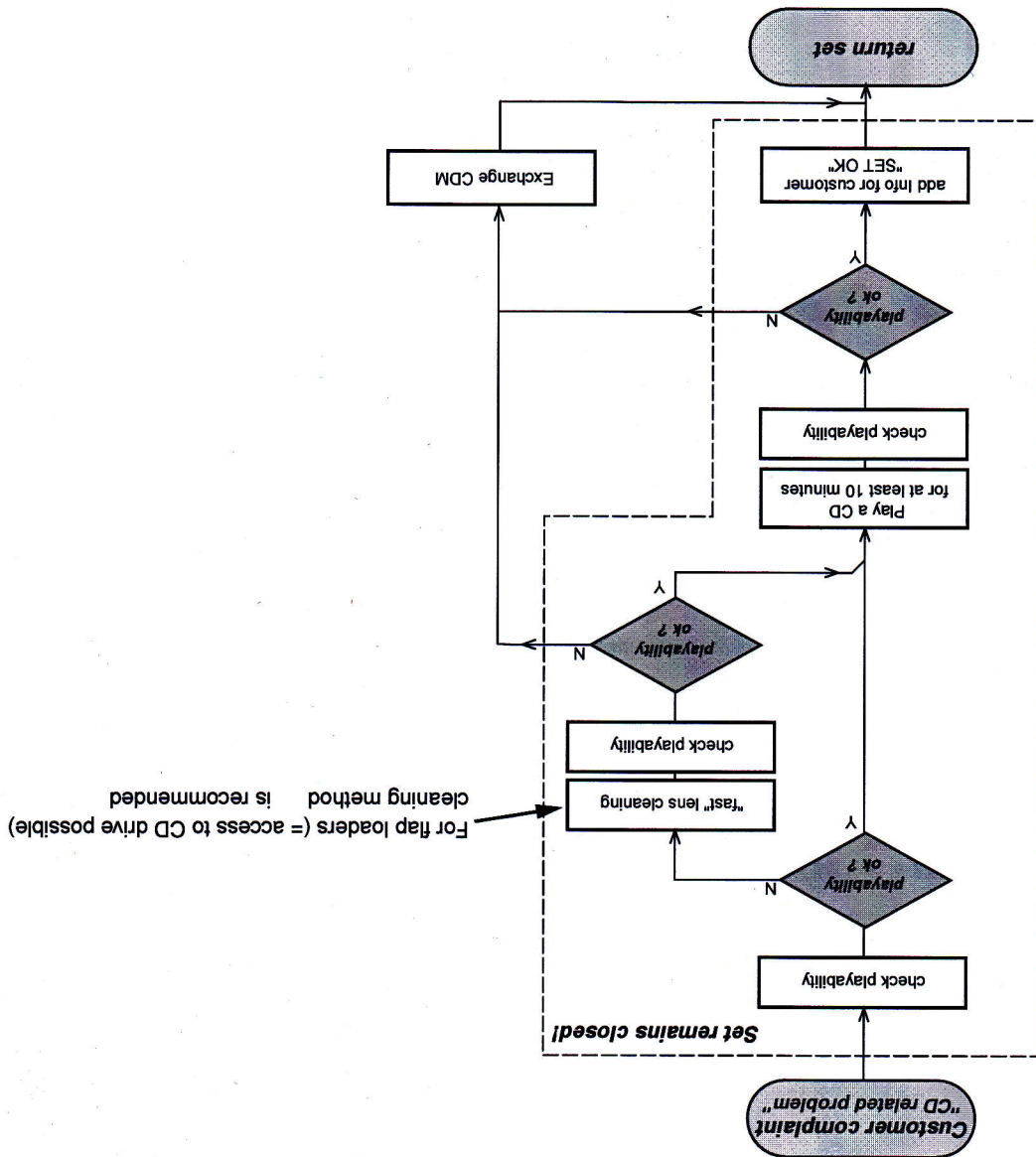

- For description - see following pages

SERVICE AIDS



WARNING

All ICs and many other semi-conductors are susceptible to electrostatic discharges (ESD). Careless handling during repair can reduce life drastically. When repairing, make sure that you are connected with the same potential as the mass of the set via a wrist wrap with resistance. Keep components and tools also at this potential.



Safety regulations require that the set be restored to its original condition and that parts which are identical with those specified, be used

Safety components are marked by the symbol .



ESD

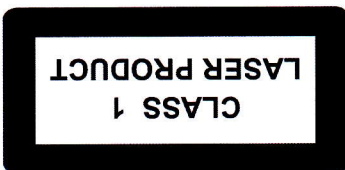

INFORMATION ABOUT LEAD-FREE SOLDERING

Philips CE is producing lead-free sets from 1.1.2005 onwards.

IDENTIFICATION:

Regardless of special logo (not always indicated) one must treat all sets from 1 Jan 2005 onwards, according next rules:



- On our website www.atyourservice.ce.philips.com you find more information to:

- * BGA-de-/soldering (+ baking instructions)
- * Heating-profiles of BGAs and other ICs used in Philips-sets
- * Lead free

You will find this and more technical information within the "magazine", chapter "workshop news".

For additional questions please contact your local repair-helpdesk.

SERVICE INSTRUCTION

Safety regulations require that after a repair, the set must be returned in its original condition. Pay in particular attention to the following points:

- Route the wire trees correctly and fix them with the mounted cable clamps.
 - Check the insulation of the AC Power lead for external damage.
 - Check the strain relief of the AC Power cord for proper function.
 - Check the electrical DC resistance between the AC Power Plug and the secondary side (only for sets which have a AC Power isolated power supply):
1. Unplug the AC Power cord and connect a wire between the two pins of the AC Power plug.
 2. Set the AC Power switch to the "on" position (keep the AC Power cord unplugged).
 3. Measure the resistance value between the pins of the AC Power plug and the metal shielding of the tuner or the aerial connection on the set. The reading should be larger than 4.5 Mohm (For U.S. it should be between 4.2 Mohm and 12 Mohm).
 4. Switch "off" the set, and remove the wire between the two pins of the AC Power plug.

- Check the cabinet for defects, to avoid touching of any inner parts by the customer.

MEASUREMENT SETUP

Tuner FM

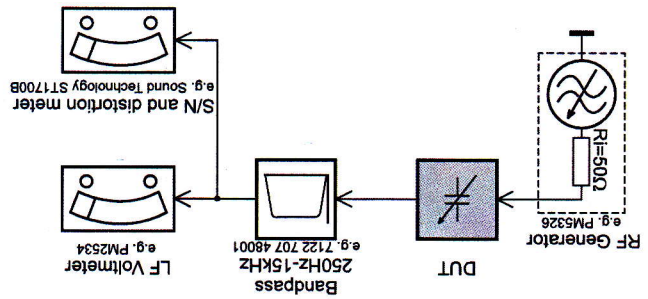

Use a bandpass filter to eliminate hum (50Hz, 100Hz) and disturbance from the pilotone (19kHz, 38kHz).

Tuner AM (MW/LW)

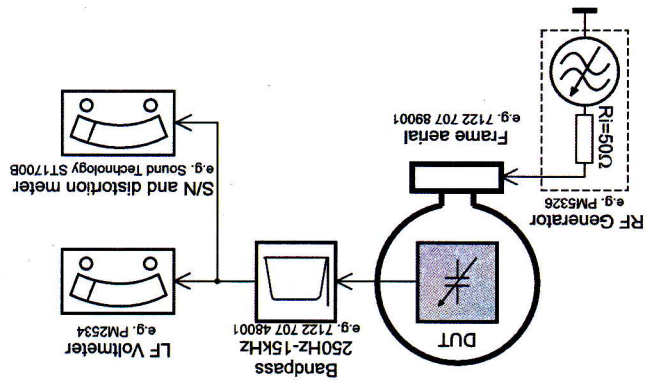

To avoid atmospheric interference all AM-measurements have to be carried out in a Faraday's cage. Use a bandpass filter (or at least a high pass filter with 250Hz) to eliminate hum (50Hz, 100Hz).

CD

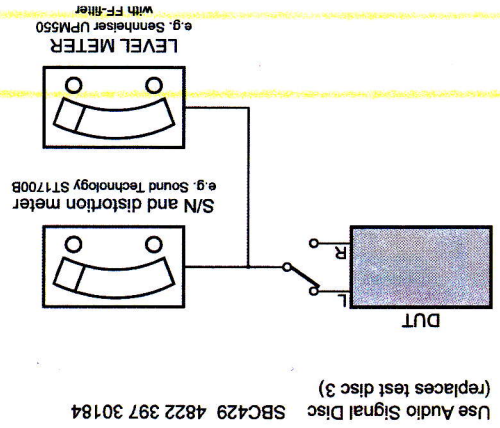

Use Audio Signal Disc SBC429 4822 397 30184
(replaces test disc 3)

Recorder

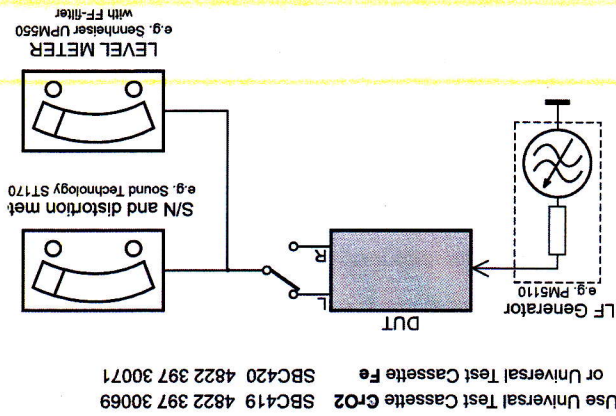

Use Universal Test Cassette **C02** SBC419 4822 397 30069
or Universal Test Cassette **Fa** SBC420 4822 397 30071

SERVICE AIDS

(GB) WARNING

All ICs and many other semi-conductors are susceptible to electrostatic discharges (ESD). Careless handling during repair can reduce life drastically. When repairing, make sure that you are connected with the same potential as the mass of the set via a wrist wrap with resistance. Keep components and tools also at this potential.



ESD

(GB)

Safety regulations require that the set be restored to its original condition and that parts which are identical with those specified, Safety components are marked by the symbol ▲.

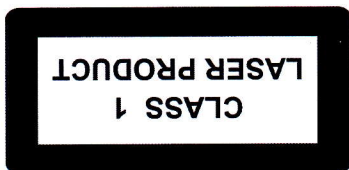

INFORMATION ABOUT LEAD-FREE SOLDERING

Philips CE is producing lead-free sets from 1.1.2005 onwards.

IDENTIFICATION:

Regardless of special logo (not always indicated) one must treat all sets from 1 Jan 2005 onwards, according next rules:



- On our website www.atyourservice.ce.philips.com you find more information to:

- * BGA-de-/soldering (+ baking instructions)
- * Heating-profiles of BGAs and other ICs used in Philips-sets
- * Lead free

You will find this and more technical information within the "magazine", chapter "workshop news".

For additional questions please contact your local repair-helpdesk.

SERVICE INSTRUCTION

Safety regulations require that after a repair, the set must be returned in its original condition. Pay in particular attention to the following points:

- Route the wire trees correctly and fix them with the mounted cable clamps.
 - Check the insulation of the AC Power lead for external damage.
 - Check the strain relief of the AC Power cord for proper function.
 - Check the electrical DC resistance between the AC Power Plug and the secondary side (only for sets which have a AC Power isolated power supply):
1. Unplug the AC Power cord and connect a wire between the two pins of the AC Power plug.
 2. Set the AC Power switch to the "on" position (keep the AC Power cord unplugged).
 3. Measure the resistance value between the pins of the AC Power plug and the metal shielding of the tuner or the aerial connection on the set. The reading should be larger than 4.5 Mohm (For U.S. it should be between 4.2 Mohm and 12 Mohm).
 4. Switch "off" the set, and remove the wire between the two pins of the AC Power plug.

- Check the cabinet for defects, to avoid touching of any inner parts by the customer.

CIRCUIT DIAGRAM - SERVO BOARD

6 - 1

6 - 1

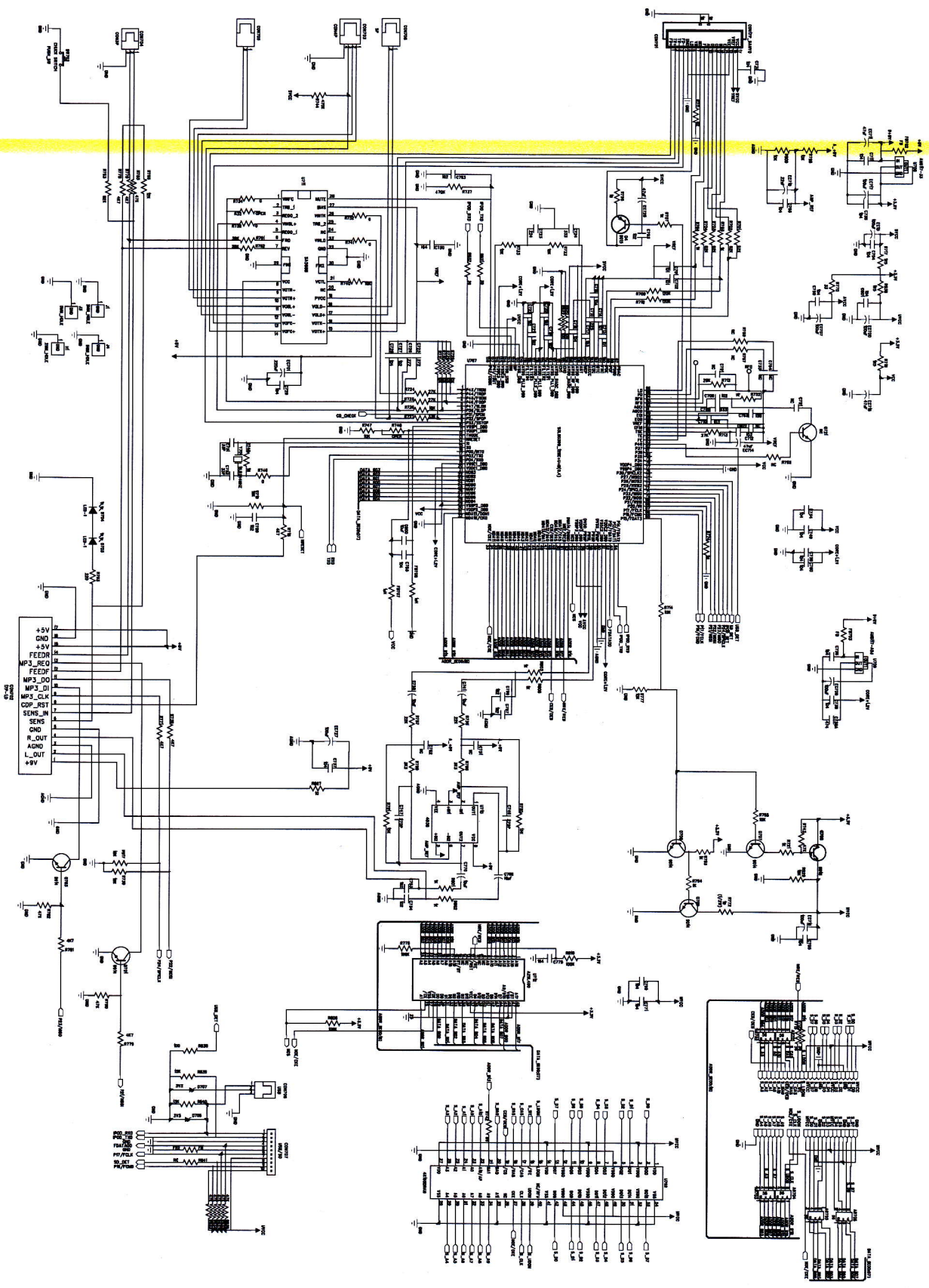

LAYOUT DIAGRAM - SERVO BOARD
COMPONENT SIDE VIEW

6-2

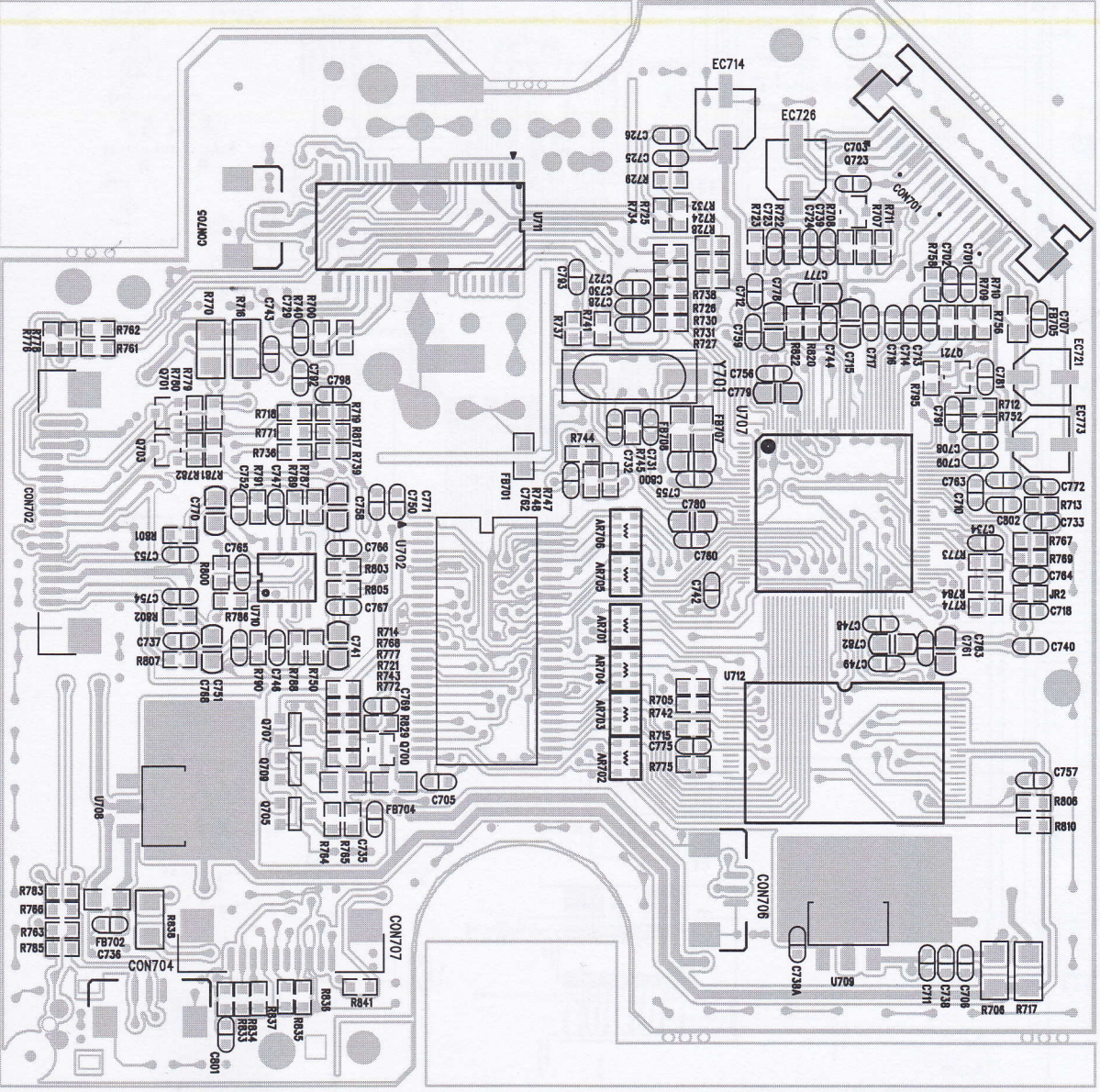

6-2

LAYOUT DIAGRAM - MAIN BOARD
COMPONENT SIDE VIEW

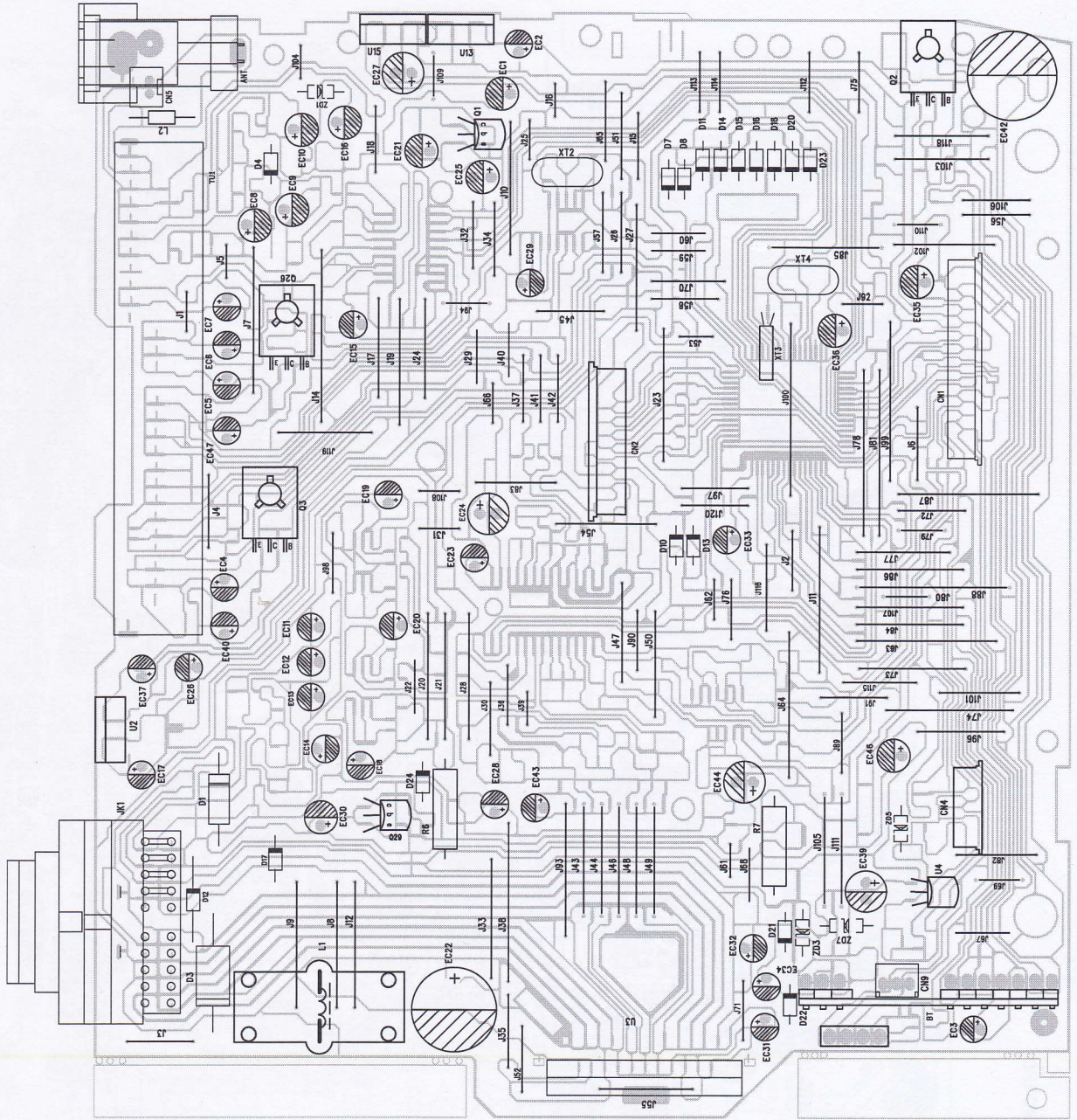

LAYOUT DIAGRAM - MAIN BOARD
COPPER SIDE VIEW

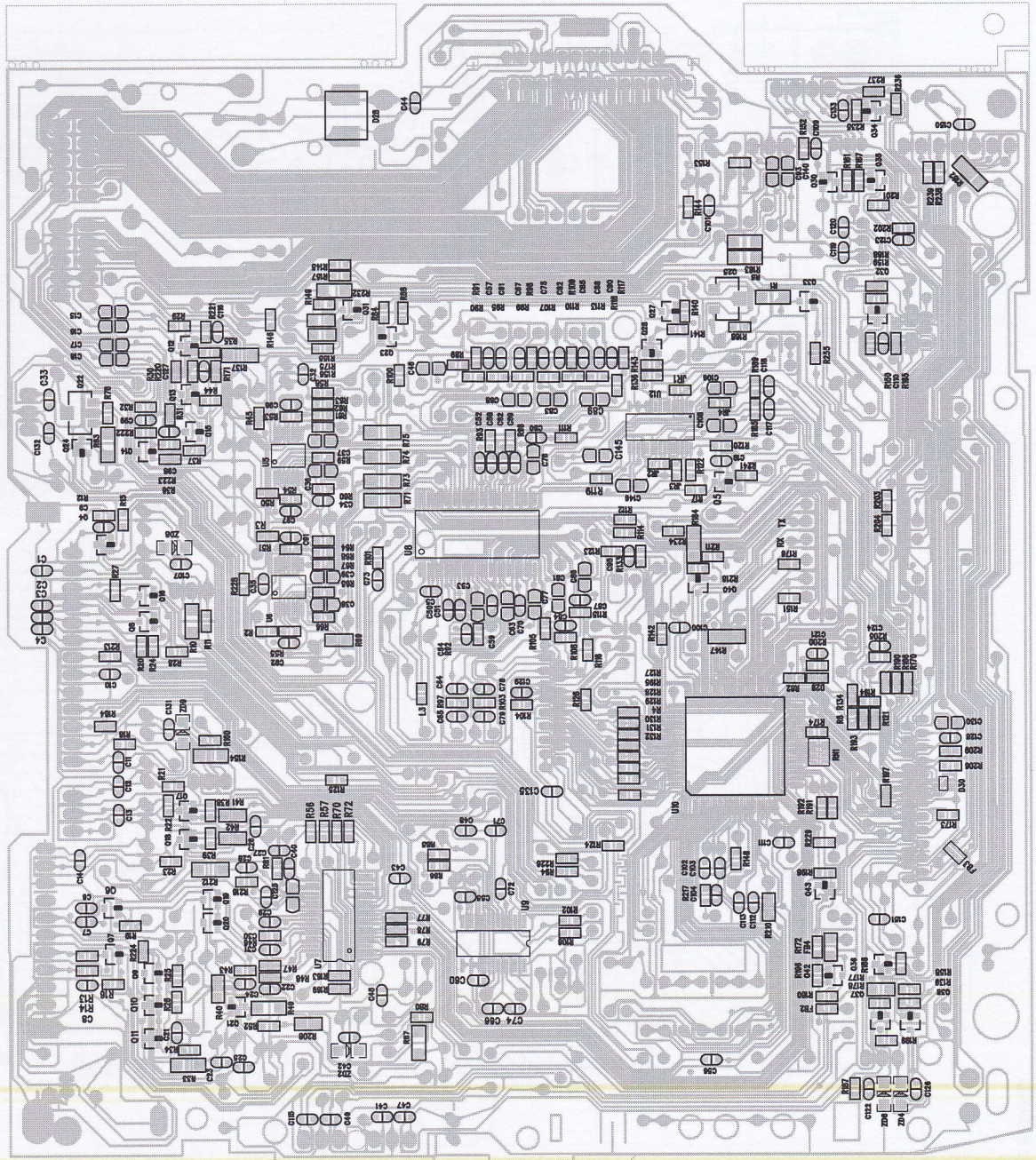

LAYOUT DIAGRAM - SERVO BOARD
COPPER SIDE VIEW

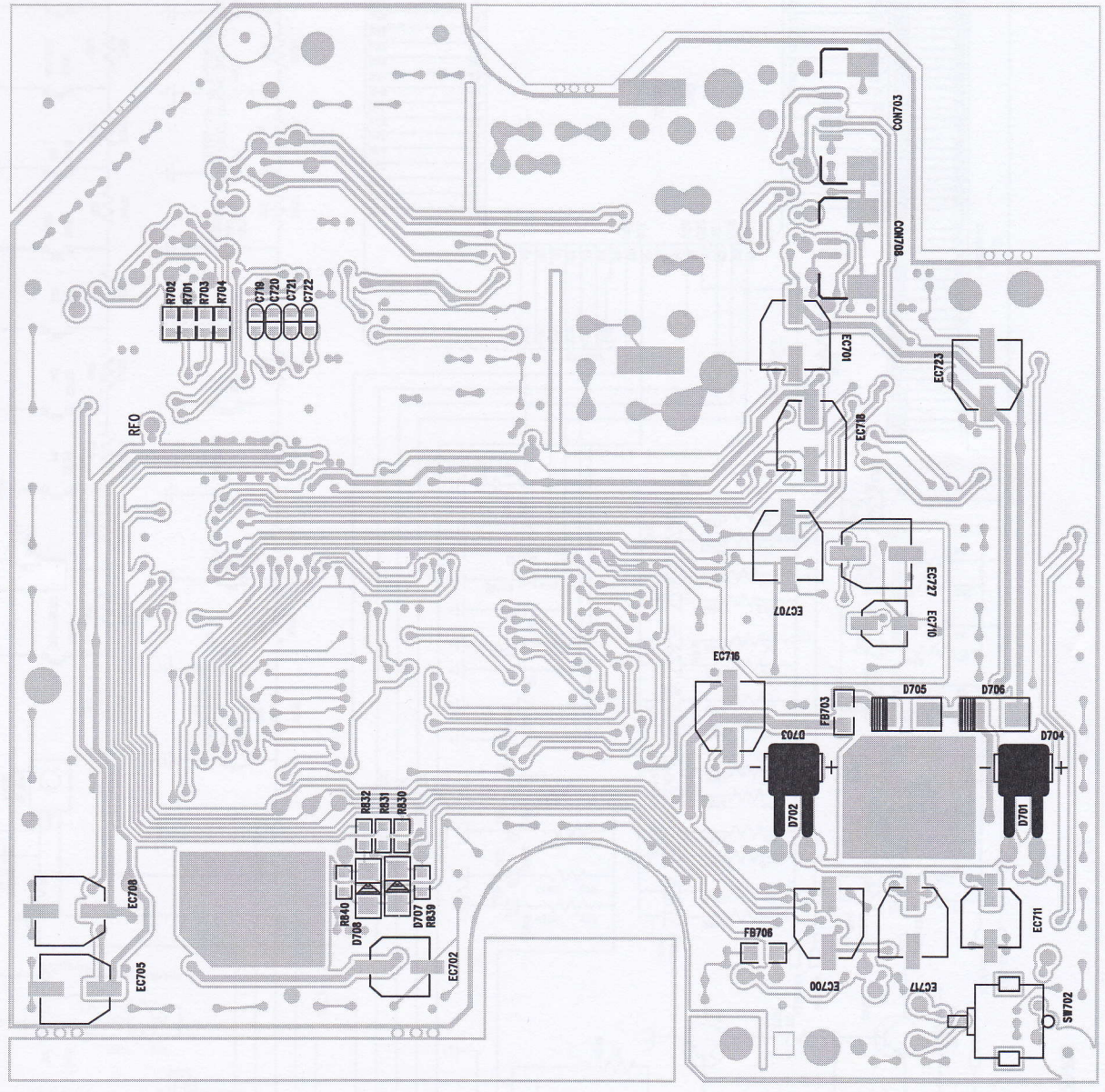

CIRCUIT DIAGRAM - PANEL BOARD

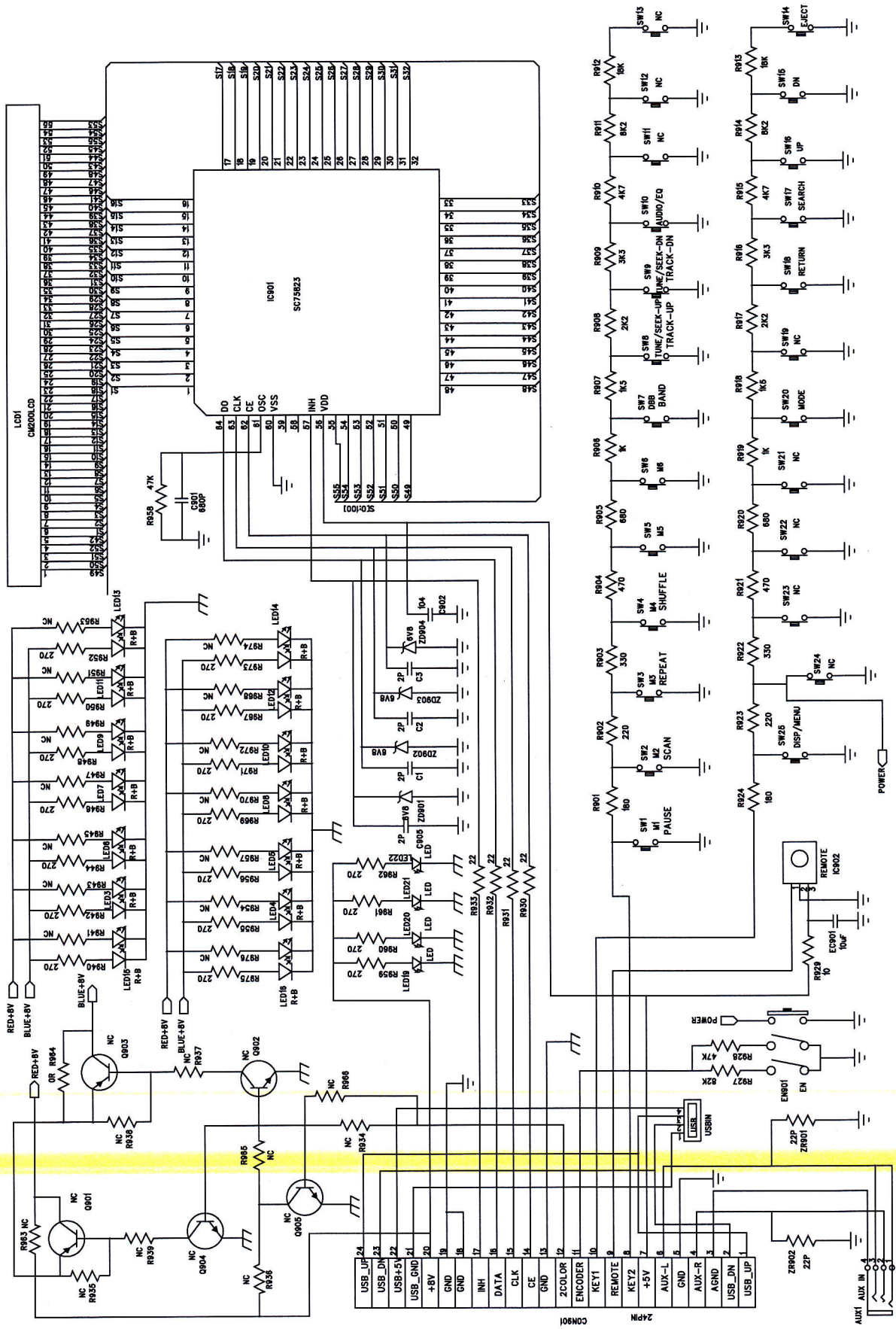

LAYOUT DIAGRAM - PANEL BOARD
COMPONENT SIDE VIEW

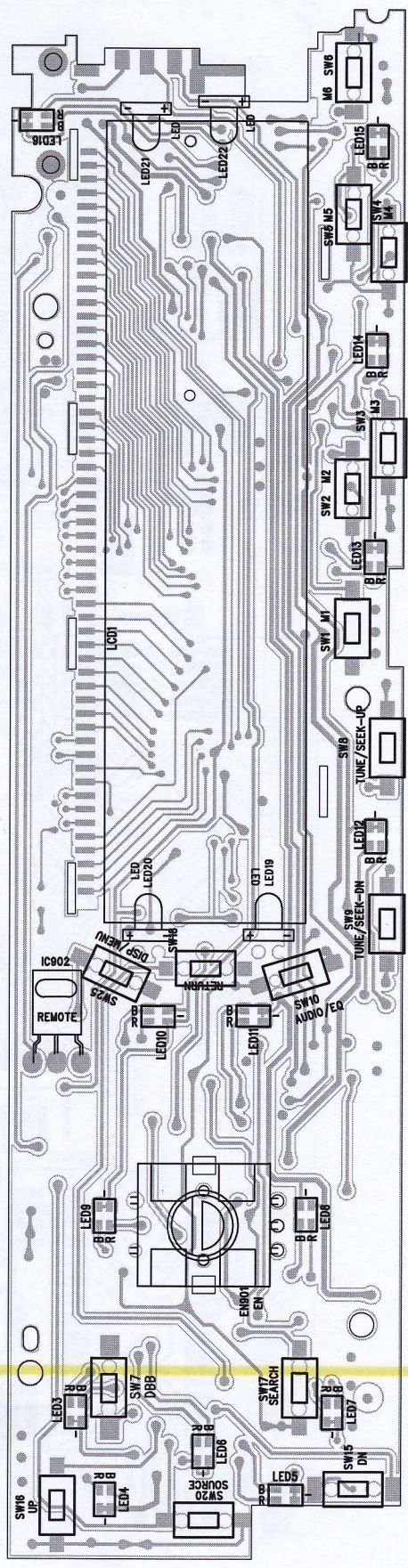

DATE: 11/11/01
PAGE: 1 OF 1

LAYOUT DIAGRAM - PANEL BOARD
COPPER SIDE VIEW

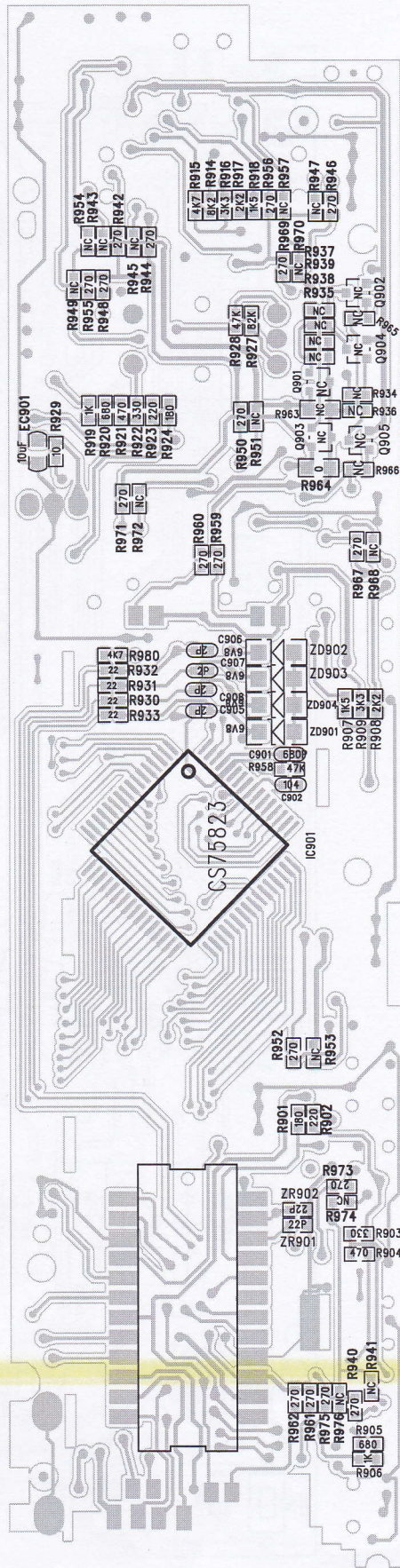

8-1

8-1

EXPLODED VIEW DIAGRAM

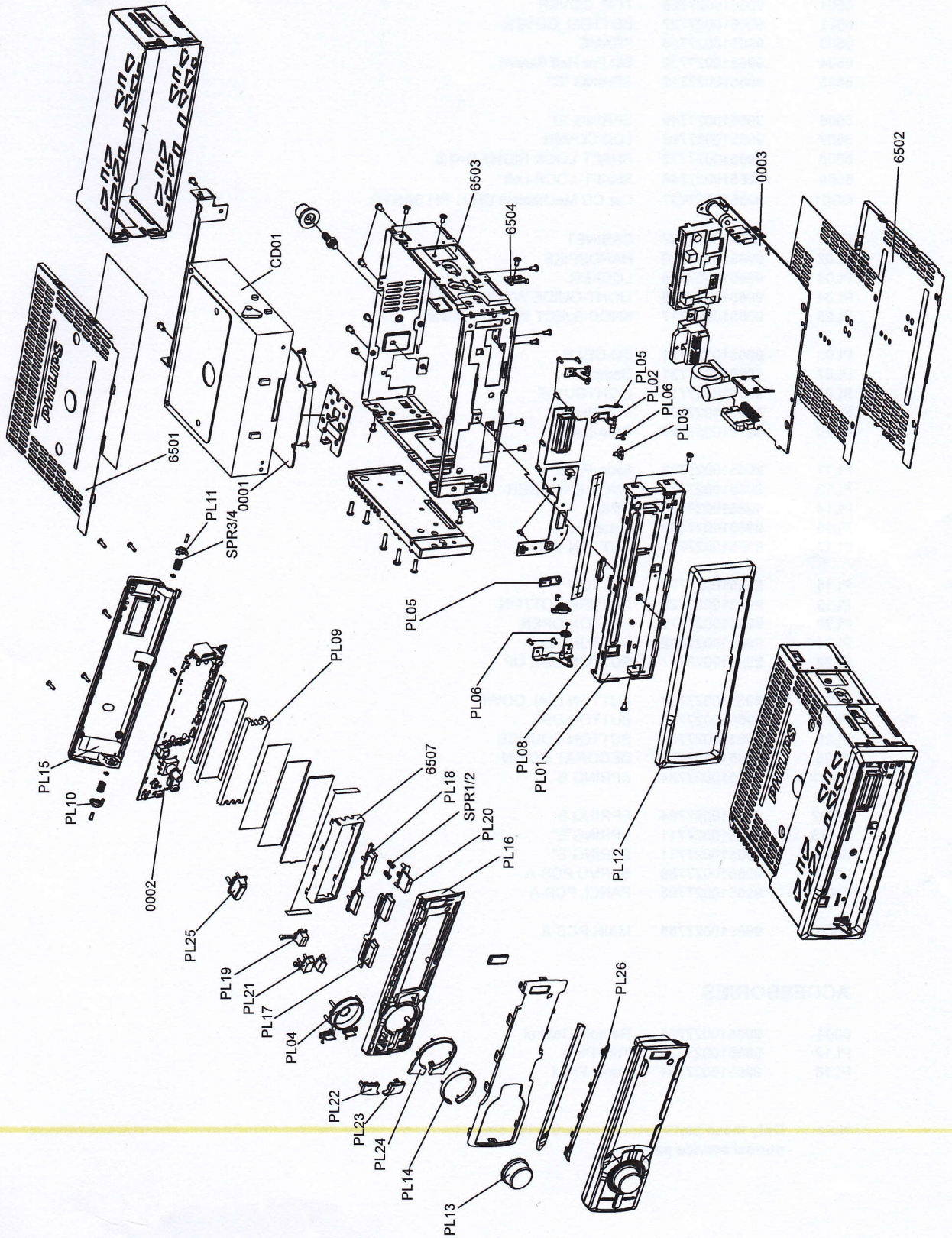

MECHANICAL PARTSLIST

6501	996510027725	TOP_COVER
6502	996510027727	BOTTOM_COVER
6503	996510027756	FRAME
6504	996510027759	Bkt For Half Sleeve
6505	996510027712	SPRING "C"
6506	996510027749	SPRING "D"
6507	996510027792	LCD COVER
6508	996510027773	SHAFT-LOCK-RIGHT D=2.8
6509	996510027746	SHAFT-LOCK-Left
CD01	996510027757	Car CD Mechanism CR01-PH SANYO
PL01	996510027787	CABINET
PL02	996510027726	HANDSPIKE
PL03	996510027769	LOCKER
PL04	996510027778	LIGHT-GUIDE W/Silkscreen white
PL05	996510027717	KNOB-EJECT W/Spray Shining
PL06	996510027721	6M-GEAR
PL07	996510027731	Damper
PL08	996510027714	LIGHTGUIDE
PL09	996510027796	LCD Bracket
PL10	996510027737	Slide-Left
PL11	996510027722	Slide-Right
PL13	996510027732	KNOB ENCODER
PL14	996510027788	RING
PL15	996510027789	Panel Back
PL17	996510027781	BUTTON SKIP
PL18	996510027708	BUTTON 1
PL19	996510027729	RETURN BUTTON
PL20	996510027779	BUTTON OPEN
PL21	996510027752	BUTTON EQ
PL22	996510027747	BUTTON DIAL UP
PL23	996510027734	BUTTON DIAL DOWN
PL24	996510027745	BUTTON DBB
PL25	996510027767	BUTTON SOURCE
PL26	996510027766	DECORAT DOWN
SPR1	996510027784	SPRING B
SPR2	996510027784	SPRING B
SPR3	996510027711	SPRING"E"
SPR4	996510027711	SPRING"E"
0001	996510027768	SERVO PCB-A
0002	996510027795	PANEL PCB-A
0003	996510027785	MAIN PCB-A

ACCESSORIES

0004	996510027724	Remote Control
PL12	996510027735	Trim Plate
PL16	996510027794	Panel Front

Note: Only these parts mentioned in the list are normal service parts.

ELECTRICAL PARTSLIST**PANEL BOARD ASSEMBLY**

IC901	996510027793	IC SC75823
LCD1	996510027791	LCD
LED10	996510027742	LED(SMD 0603)Size=1.6x0.8x0.8
LED11	996510027742	LED(SMD 0603)Size=1.6x0.8x0.8
LED12	996510027742	LED(SMD 0603)Size=1.6x0.8x0.8
LED13	996510027742	LED(SMD 0603)Size=1.6x0.8x0.8
LED14	996510027742	LED(SMD 0603)Size=1.6x0.8x0.8
LED15	996510027742	LED(SMD 0603)Size=1.6x0.8x0.8
LED16	996510027742	LED(SMD 0603)Size=1.6x0.8x0.8
LED19	996510027741	LED D3xL4.15mm
LED20	996510027741	LED D3xL4.15mm
LED21	996510027741	LED D3xL4.15mm
LED22	996510027741	LED D3xL4.15mm
LED3	996510027742	LED(SMD 0603)Size=1.6x0.8x0.8
LED4	996510027742	LED(SMD 0603)Size=1.6x0.8x0.8
LED5	996510027742	LED(SMD 0603)Size=1.6x0.8x0.8
LED6	996510027742	LED(SMD 0603)Size=1.6x0.8x0.8
LED7	996510027742	LED(SMD 0603)Size=1.6x0.8x0.8
LED8	996510027742	LED(SMD 0603)Size=1.6x0.8x0.8
LED9	996510027742	LED(SMD 0603)Size=1.6x0.8x0.8
PJ1	996510027743	Minature Ph Jack
RE1	996510027772	Rotary Encoder
SW1	996510027723	Surface Mount Tact Switch
SW10	996510027723	Surface Mount Tact Switch
SW11	996510027723	Surface Mount Tact Switch
SW12	996510027723	Surface Mount Tact Switch
SW13	996510027723	Surface Mount Tact Switch
SW14	996510027723	Surface Mount Tact Switch
SW15	996510027723	Surface Mount Tact Switch
SW16	996510027723	Surface Mount Tact Switch
SW2	996510027723	Surface Mount Tact Switch
SW3	996510027723	Surface Mount Tact Switch
SW4	996510027723	Surface Mount Tact Switch
SW5	996510027723	Surface Mount Tact Switch
SW6	996510027723	Surface Mount Tact Switch
SW7	996510027723	Surface Mount Tact Switch
SW8	996510027723	Surface Mount Tact Switch
SW9	996510027723	Surface Mount Tact Switch
US1	996510027761	USB Socket. Flex Type

Note: Only these parts mentioned in the list are normal service parts.

ELECTRICAL PARTSLIST**MAIN BOARD ASSEMBLY**

ANT	996510027755	Antenna Socket
FFC2	996510027733	FFC 7 pin UL20624 P=1.0 L=35
FFC3	996510027739	FFC 24 pin UL20624 P=1.0 L=30
FU1	 996510027762	W/15A Fuse
L1	996510027719	Ferrite Choke Transformer
S1	996510027777	Surface Mount Tact Sw H=5.2
S2	996510027744	Surface Mount Tact Switch 4Pin
S3	996510027758	Push Switch
TU1	996510027706	Tuner Pack KST-C4011LVD-151T
U10	996510027783	IC Supported USB/SD/MP3/WMA
U13	996510027763	IC L7809CV
U15	996510027776	IC L7805CV
U2	996510027763	IC L7809CV
U3	996510027707	IC TDA7388
U4	996510027736	IC LM2950L-50
U5	996510027771	IC LS4558F SOP-8 Op
U7	996510027782	IC PLL - DTS LP9257 SOP-20-300-
U8	996510027775	IC 7313
U9	996510027751	IC RDS Demodulator LP6579
XT2	996510027713	Crystal 4.332MHz
XT3	996510027748	Crystal 32.768 KHz
XT4	996510027774	Crystal 7.2MHz

SERVO BOARD ASSEMBLY

D703	996510027764	Infrared LED BIR-HM133A-TRB
D704	996510027764	Infrared LED BIR-HM133A-TRB
D705	996510027709	Rectifier SMD M7 1.0A/1000V
FFC1	996510027728	FFC 16 Pin UL2896 P=1.0 L=100
SW702	996510027718	Push Switch SW-111
U702	996510027753	IC IS42S16400F-7TL
U707	996510027754	IC S5L8030U
U708	996510027738	IC AP1117 3.3V SOT223-3L
U709	996510027715	IC AP1117-ADJ +/-2%1A
U710	996510027771	IC LS4558F SOP-8 Op
U711	996510027716	IC SA5888
U712	996510027786	IC S29AL004D70TF102
Y701	996510027765	Crystal SMD 16.9344MHz