

Register your product and get support at
www.philips.com/welcome

CED750



EN User manual

PHILIPS

Contents

1 Important	4
Safety	4
Notice	4
2 Your Car Entertainment System	6
Introduction	6
What's in the box	6
Overview of the main unit	7
Overview of the remote control	8
3 Get started	10
Install the car audio	10
Install remote control battery	16
Turn on	17
Set clock	17
4 Listen to radio	18
Tune to a radio station	18
Store radio stations in memory	18
Tune to a preset station	19
5 Play	20
Load discs	20
Insert USB or SD/MMC card	20
Play/Pause	21
Search for a folder	21
Search within a title/folder	21
Repeat	22
Repeat a section	22
Random play	22
Select audio language	23
Select audio mode	23
Select subtitle language	23
Change view angle	23
Rotate pictures	23
Zoom	23
Select slide show duration	24
6 Play with Bluetooth device	25
Pair the Bluetooth-enabled devices	25
Make a call	25
Receive call	26
Switch phone call to the mobile	26
Listen to music from Bluetooth device	26
7 Adjust sound	27
Adjust volume	27
Mute	27
Select preset equalizer	27
Adjust fader/balance	27
8 Adjust settings	28
Adjust general system settings	28
Adjust sound settings	29
Adjust video settings	29
Adjust Bluetooth settings	29
Adjust language settings	30
Adjust volume settings	30
Adjust DVD rating	31
9 Others	32
Listen to other devices	32
Reset	32
Remove the unit	32
Replace fuse	33
10 Product information	34
11 Troubleshooting	36
About Bluetooth device	36
12 Glossary	38

1 Important

Safety

- Read and understand all instructions before you use your unit. If damage is caused by failure to follow instructions, the warranty does not apply.
- Use of controls or adjustments or performance of procedures other than herein may result in hazardous radiation exposure or other unsafe operation.
- This unit is designed for negative ground (earth) 12V DC operation only.
- To reduce the risk of traffic accident, do not watch video during driving.
- To ensure safe driving, adjust the volume to a safe and comfortable level.
- Improper fuses can cause damage or fire. When you need to change the fuse, consult a professional.
- Use only the supplied mounting hardware for a safe and secure installation.
- To avoid short circuit, do not expose the unit, remote control or remote control batteries to rain or water.
- Never insert objects into the ventilation slots or other openings on the unit.
- Clean the unit and frame with a soft, damp cloth. Never use substances such as alcohol, chemicals or household cleaners on the unit.
- Never place any objects other than discs into the unit.
- Never use solvents such as benzene, thinner, cleaners available commercially, or anti-static sprays intended for discs.
- Visible and invisible laser radiation when open. Avoid exposure to beam.
- Risk of damage to the unit screen! Never touch, push, rub or strike the screen with any object.

Notice

Notice of compliance

The set complies with the FCC-Rules, Part 15 and with 21 CFR 1040.10. Operation is subject to the following two conditions:

1. This device may not cause harmful interference, and
2. This device must accept any interference received, including interference that may cause undesired operation.

FCC Notice (For U.S. and Canada)

Note:

This equipment has been tested and found to comply with the limits for a Class B digital device, pursuant to part 15 of the FCC Rules. These limits are designed to provide reasonable protection against harmful interference in a residential installation. This equipment generates, uses, and can radiate radio frequency energy and, if not installed and used in accordance with the instruction manual, may cause harmful interference to radio communications. However, there is no guarantee that interference will not occur in a particular installation. If this equipment does cause harmful interference to radio or television reception, which can be determined by turning the equipment off and on, the user is encouraged to try to correct the interference by one or more of the following measures:

- Relocate the receiving antenna.
- Increase the separation between the equipment and receiver
- Connect the equipment into an outlet on a circuit different from that to which the receiver is connected.
- Consult the dealer or an experienced radio/TV technician for help.

IMPORTANT!

Modifications not authorized by the manufacturer may void users authority to operate this device.

 **Be responsible**
Respect copyrights

The making of unauthorized copies of copy-protected material, including computer programs, files, broadcasts and sound recordings, may be an infringement of copyrights and constitute a criminal offence. This equipment should not be used for such purposes.

Official DivX® Certified product. Plays all versions of DivX® video (including DivX® 6) with standard playback of DivX® media files.



"DivX, DivX" Certified, and associated logos are trademarks of DivX, Inc. and are used under license.

The Bluetooth® word mark and logos are registered trademarks owned by Bluetooth SIG, Inc. and any use of such marks by Philips is under license.



Manufactured under license from Dolby Laboratories.

"Dolby" and the double-D symbol are trademarks of Dolby Laboratories.

Other trademarks and trade names are those of their respective owners.

This unit includes this label:

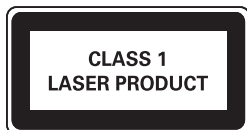

Environmental information

All unnecessary packaging has been omitted. We have tried to make the packaging easy to separate into three materials: cardboard (box), polystyrene foam (buffer) and polyethylene (bags, protective foam sheet.)

Your system consists of materials which can be recycled and reused if disassembled by a specialized company. Please observe the local regulations regarding the disposal of packaging materials, exhausted batteries and old equipment.

Any changes or modifications made to this device that are not expressly approved by Philips Consumer Lifestyle may void the user's authority to operate the equipment.

2008 © Koninklijke Philips Electronics N.V. All rights reserved.

Specifications are subject to change without notice. Trademarks are the property of Koninklijke Philips Electronics N.V. or their respective owners. Philips reserves the right to change products at any time without being obliged to adjust earlier supplies accordingly.

2 Your Car Entertainment System

Congratulations on your purchase, and welcome to Philips! To fully benefit from the support that Philips offers, register your product at www.Philips.com/welcome.

Introduction

With the car entertainment system, you and your passengers can enjoy:

- Audio/video/JPEG pictures from
 - DVD, VCD or CD
 - USB devices
 - SD/SDHC/MMC cards
 - External devices
- FM or AM (MW) radio
- Audio from Bluetooth-enabled devices

You can also make/receive phone calls with Bluetooth-enabled devices.

What's in the box

Check and identify the contents of your package:

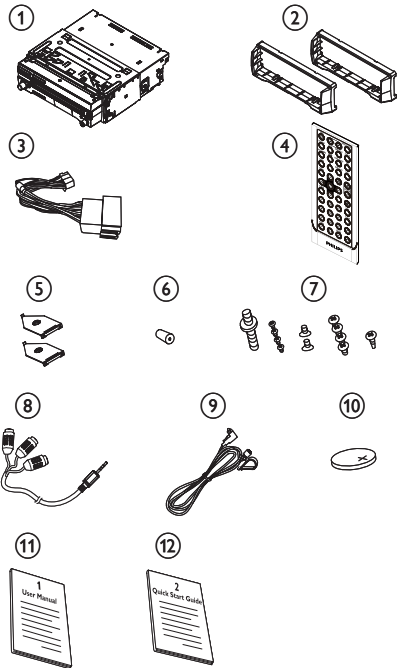

- ① Main unit
- ② Trim plate x 2 pcs
- ③ Standard connector
- ④ Remote control
- ⑤ Short mounting bracket x 2 pcs
- ⑥ Rubber cushion
- ⑦ Screws
 - M5x16mm x 1 pcs
 - M4x3mm x 4 pcs
 - M5x5mm x 2 pcs
 - M5x5.5mm x 4 pcs
 - M5x6mm x 1 pc
- ⑧ AV cable
- ⑨ Bluetooth microphone cable
- ⑩ Remote control battery
- ⑪ User manual
- ⑫ Quick start guide

Overview of the main unit

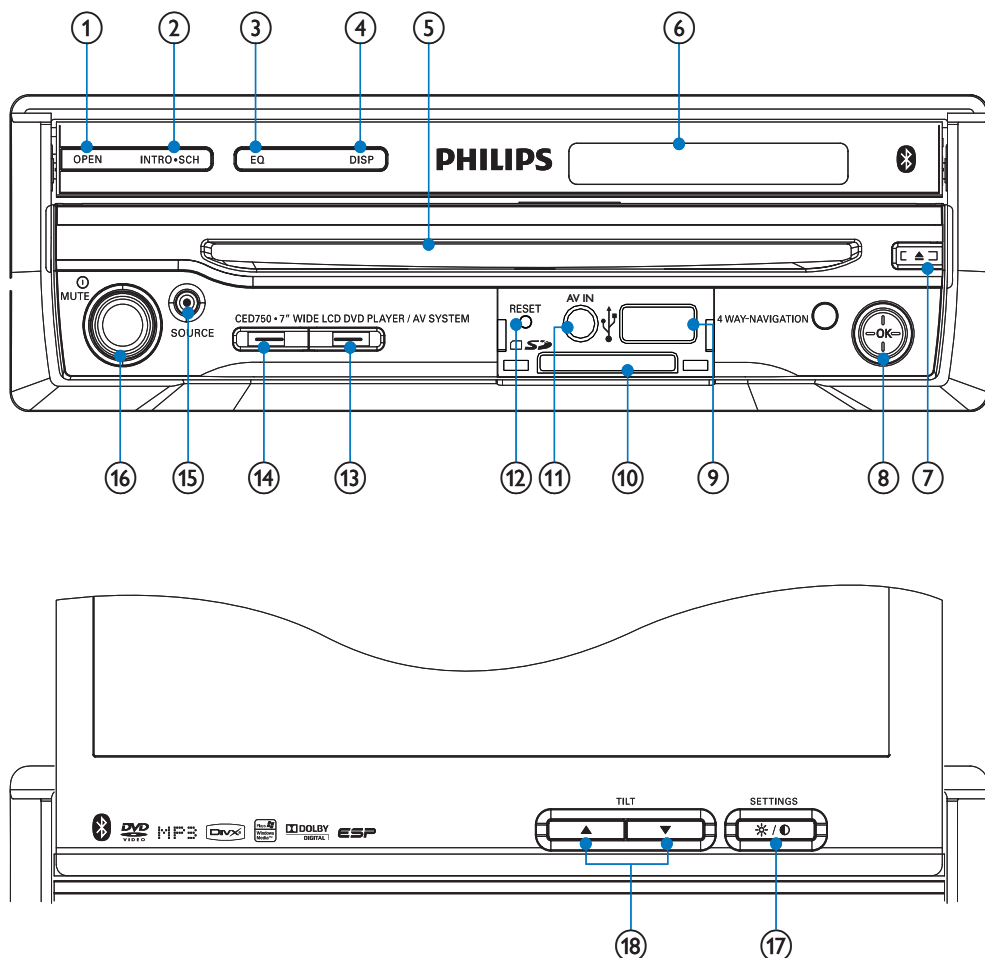

- | | |
|---|---|
| <p>① OPEN</p> <ul style="list-style-type: none"> • Open or close the screen. <p>② INTRO.SCH</p> <ul style="list-style-type: none"> • Search for radio station. • Search for radio station and save the top six stations with strong signal into preset channels automatically. <p>③ EQ</p> <ul style="list-style-type: none"> • Select equalizer (EQ) setting. | <p>④ DISP</p> <ul style="list-style-type: none"> • Display play information. <p>⑤ Disc slot</p> <p>⑥ Small screen</p> <p>⑦ ▲</p> <ul style="list-style-type: none"> • Eject disc. |
|---|---|

⑧ 4 WAY NAVIGATION

- Navigate to left/right
Tune for radio station.
Skip to the previous/next track/
chapter.
Move cursor to left/right.
- Navigate up/down
Skip to the previous/next preset
station.
Skip to the previous/next folder
Search backward/forward.
Move cursor up/down.
- Press
Start play or pause.
Confirm selection.

⑨

- USB socket

⑩ SD/SDHC/MMC card slot

⑪ AV IN

- External equipment audio/video in
socket

⑫ RESET

- Reset the unit when it hangs up.

⑬ — (red)

- Terminate call.

⑭ — (green)

- Answer phone.
- Dial number.

⑮ SOURCE

- Select source.

⑯

- Turn the unit on or off.
- Turn mute on or off.
- Adjust volume.

⑰

- Adjust screen brightness and contrast.

⑱ ▲ TILT ▼

- Adjust tilt of the screen.

Overview of the remote control

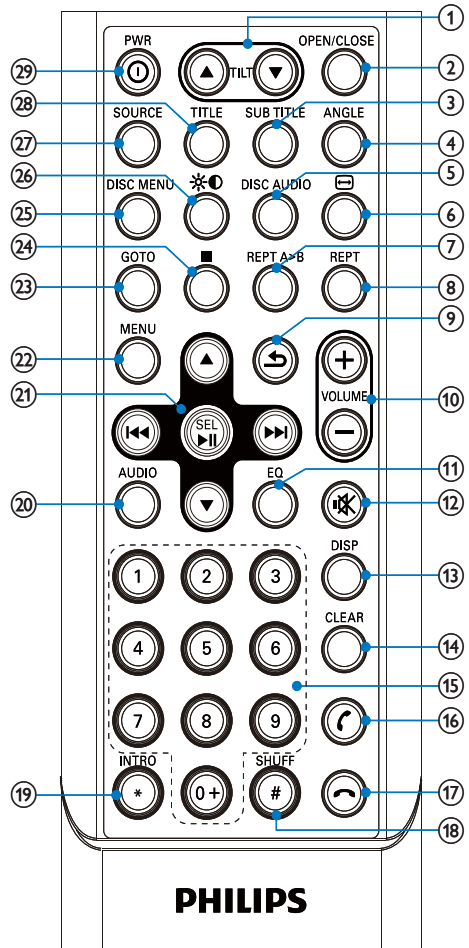

① ▲ TILT ▼

- Adjust tilt of the screen.

② OPEN/CLOSE









- Open or close the screen.

③ SUBTITLE

- Select DVD or DivX subtitle language.

④ ANGLE

- Select a difference angle/version of
the current DVD scene.

- ⑤ **DISC AUDIO**
- Select audio language or audio channel.
- ⑥ 
- Change to wide screen display.
- ⑦ **REPT A->B**
- Set A-B repeat play.
- ⑧ **REPT**
- Select repeat play mode.
- ⑨ 
- Return to previous menu or exit.
- ⑩ **VOLUME +/-**
- Adjust volume.
- ⑪ **EQ**
- Select equalizer (EQ) setting.
- ⑫ 
- Mute or unmute audio.
- ⑬ **DISP**
- Display play information.
- ⑭ **CLEAR**
- Delete entered numbers.
- ⑮ **Numeric keypad**
- ⑯  (green)
- Answer phone.
 - Dial number.
- ⑰  (red)
- Terminate call.
- ⑱ **SHUFF #**
- Turn random play on or off.
 - # symbol for phone call.
- ⑲ **INTRO ***
- Search for radio station and play the station for 10 seconds, then search for next station.
 - * symbol for phone call.
- ⑳ **AUDIO**
- Access audio setting menu.
- ㉑ **Navigation buttons**
- 
 - Tune for radio station.
 - Skip to previous/next track/chapter.
 - Move cursor to left/right.
 - 
 - Skip to the previous/next preset station.
 - Skip to the previous/next folder.
 - Search backward/forward for DVD video.
 - Move cursor up/down.
 - **SEL▶||**
 - Start play or pause.
 - Confirm selection.
- ㉒ **MENU**
- Access system menu
- ㉓ **GOTO**
- Select track/chapter.
- ㉔ 
- Stop play.
- ㉕ **DISC MENU**
- Return to DVD main menu.
- ㉖ 
- Adjust brightness/contrast.
- ㉗ **SOURCE**
- Select source.
- ㉘ **TITLE**
- Access or exit DVD title menu.
- ㉙ **ⓅPWR**
- Turn the unit on or off.

3 Get started

! Caution

- Use the controls only as stated in this user manual.

Always follow the instructions in this chapter in sequence.

If you contact Philips, you will be asked for the model and serial number of your unit. The model number and serial number are on the bottom of your unit. Write the numbers here:

Model No. _____

Serial No. _____

Install the car audio

These instructions are for a typical installation. However, if your car has different requirements, make the corresponding adjustment. If you have any questions regarding installation kits, consult your Philips car audio dealer.

! Caution

- This unit is designed for negative ground (earth) 12V DC operation only.
- Always install this unit in the car dashboard. Other locations can be dangerous as the rear of the unit heats up during use.
- To avoid short-circuit: before you connect, ensure that the ignition is off.
- Ensure that you connect the yellow and red power supply leads after all other leads are connected.
- Ensure that all loose leads are insulated with electrical tape.
- Ensure that the leads do not get caught under screws or parts that will move (e.g. seat rail).
- Ensure that all ground (earth) leads are run to a common ground (earth) point.
- Use only the supplied mounting hardware for a safe and secure installation.
- Improper fuses can cause damage or fire. When you need to change the fuse, consult a professional.

Note on the power supply lead (yellow)

- When you connect other devices to this unit, ensure that the rating of the car circuit is higher than the total fuse value of all the connected devices.

Notes on speaker connection

- Never connect speaker wires to the metal body or chassis of the car.
- Never connect speaker wires with stripes to one another.

Overview of parts

These are the supplied parts needed to connect and install this unit.

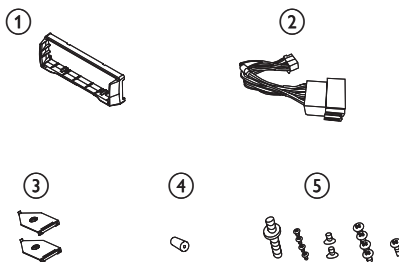

- ① Trim plate x 2 pcs
- ② Standard connector
- ③ Short mounting bracket x 2 pcs
- ④ Rubber cushion
- ⑤ Screws
 - M5x16mm x 1 pc
 - M4x3mm x 4 pcs
 - M5x5mm x 2 pcs
 - M5x5.5mm x 4 pcs
 - M5x6mm x 1 pc

Connect wires: ISO connectors

! Caution

- Ensure that all loose leads are insulated with electrical tape.

- 1 Pull out the ISO connectors from the car dashboard and connect them to the bigger end of the supplied standard connector:

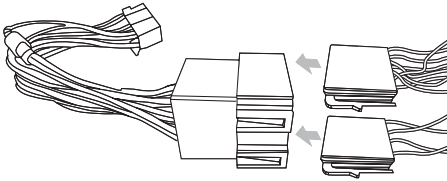

- 2 Connect the other end of supplied standard connector to the unit.

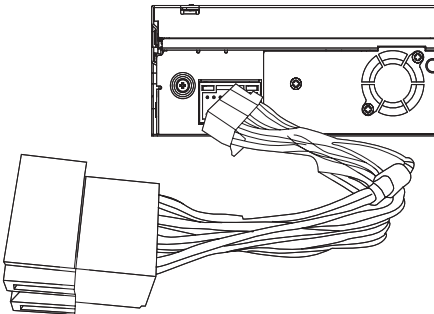

- If necessary, connect the following:

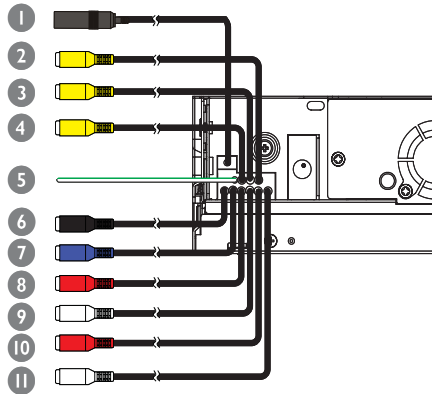

	Connector	Connect to/with
1	Black cable	Antenna
2	Yellow cable	Video out 1
3	Yellow cable	Video out 2
4	Yellow cable	Camera in
5	Green/white wire	Parking (see 'Connect parking brake wire' on page 14)
6	Black cable	Bluetooth microphone
7	Blue cable	Subwoofer
8	Red cable	Front line out L
9	White cable	Front line out R
10	Red cable	Rear line out L
11	white cable	Rear line out R

Connect wires: without ISO connectors

! Caution

- Ensure that all loose leads are insulated with electrical tape.

- 1 Cut off the bigger end of the supplied standard connector:

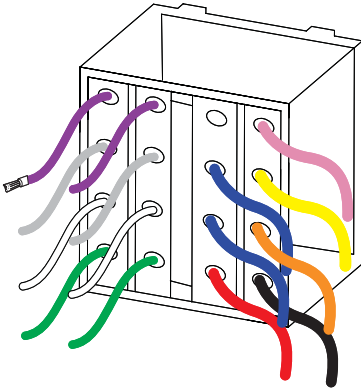

2 Check the car's wiring carefully, then connect them to the standard connector.

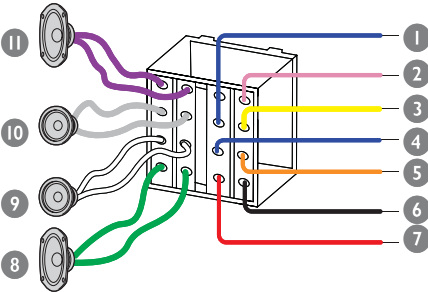

Connector	Connect to
1 Blue/white wire	The electric antenna control lead or power supply lead of the antenna booster If there is no electric antenna or antenna booster; or it is manually operated telescopic antenna, it is not necessary to connect this lead.
2 Pink wire	Reverse driving (see 'Connect reverse driving cable' on page 14)
3 Yellow wire	The +12V car battery which is live at all times.
4 Blue wire	Amp. remote
5 Orange/white wire	Illumination switch
6 Black wire	A metal surface of the car First connect the black ground (earth) lead, then connect the yellow and red power supply leads.

7	Red wire	<p>The +12V power terminal which is live in the accessory (ACC) position of the ignition switch</p> <p>If there is no accessory position, connect to the +12V car battery terminal that is always live. Be sure to connect the black ground (earth) lead to a metal surface of the car first.</p>
8	Green and green/black wires	Left speaker (Rear)
9	White and white/black wires	Left speaker (Front)
10	Gray and gray/black wires	Right speaker (Front)
11	Purple and purple/black wires	Right speaker (Rear)

- 3** Connect the supplied standard connector to the unit.

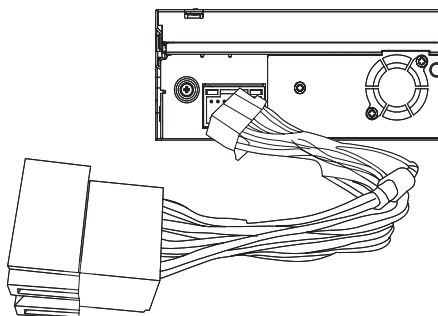

- If necessary, do the other connections. (See the last step in section **Connect wires: ISO connector**)

Connect reverse driving cable

- 1 Refer to the illustration below to connect reverse driving wire.

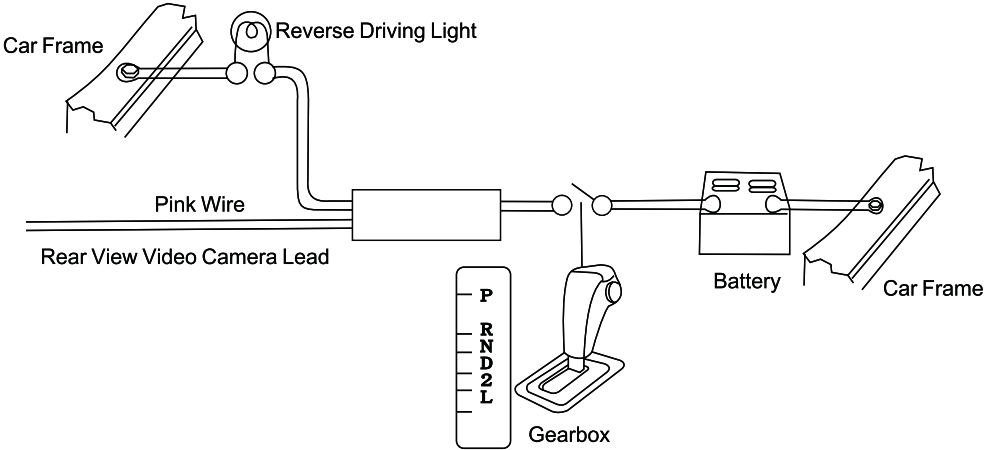

Connect parking brake wire

- 1 Refer to the illustration below to connect parking brake wire.

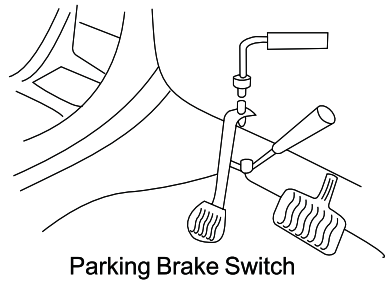
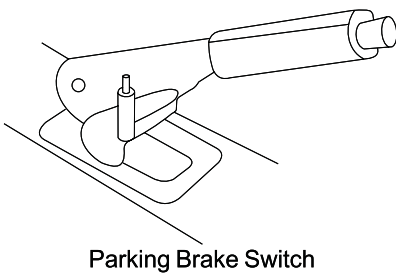
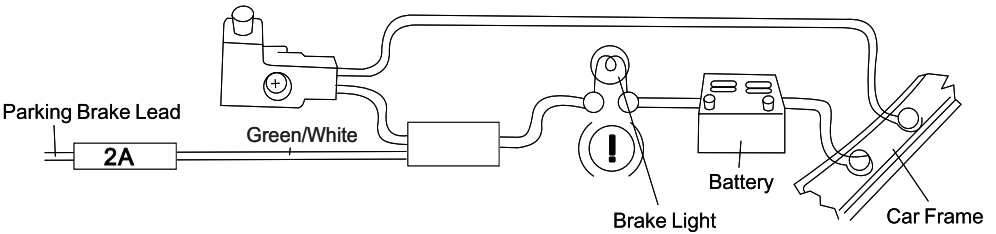

Mount in the dashboard

Note

- Check wire connection before you mount the unit into a car.
- If preset radio stations are lost when the ignition key is turned OFF and then back ON, reconnect the red leads crosswise to the yellow ones.

- 1 If the car does not have an on-board drive or navigation computer, disconnect the negative terminal of the car battery.
 - If you disconnect the car battery in a car that has an on-board drive or navigation computer, the computer may lose its memory.
 - If the car battery is not disconnected, to avoid short-circuit, ensure that bare wires do not touch each other.
- 2 Ensure that car dashboard opening is within these measurements:

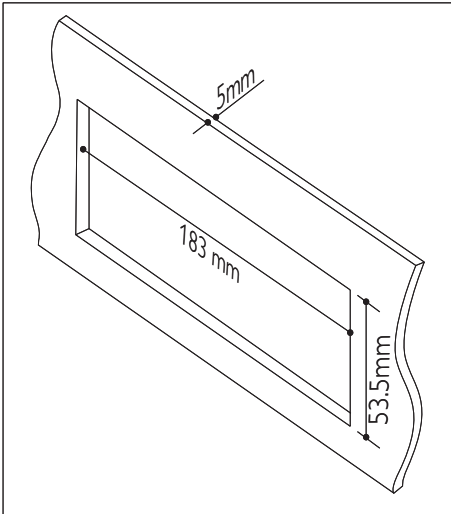

- Since the unit cannot be used if the dashboard opening's slant angle is above 20 degrees: Ensure that the horizontal slant of the car dashboard opening is between 0 and 20 degrees

- 3 Remove the screws on the both side of the unit.

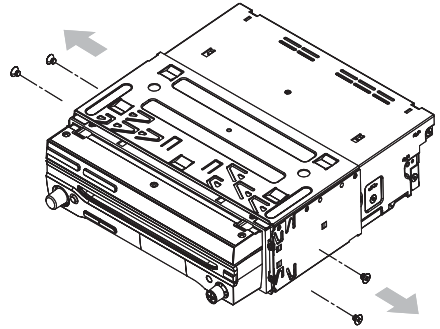

- 4 Remove the mounting sleeve.

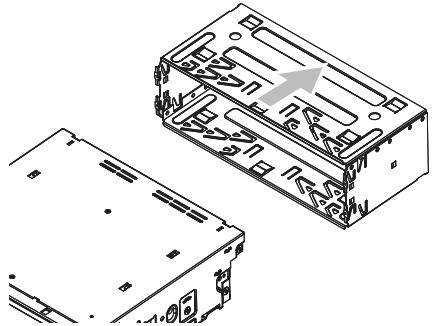

- 5 Install the sleeve into the dashboard and bend the tabs outward to fix the sleeve.

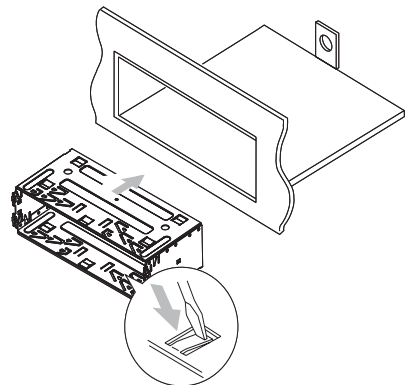

- 6 Place the rubber cushion over the end of the bolt.

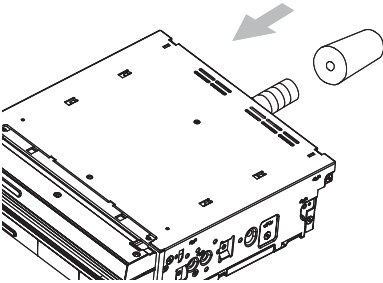

- 7 Slide the unit into the dashboard until a click sound is heard.

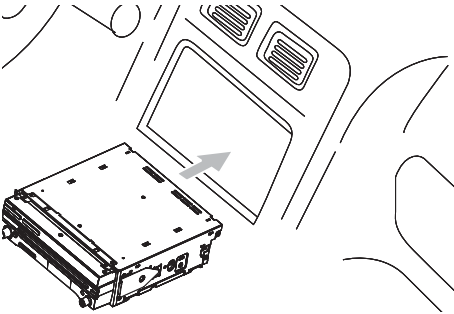

- If the unit cannot fit into the dashboard, remove the mounting bracket on the both side of the unit and replace them with the supplied short mounting brackets.

- 8 Attach the trim plate.

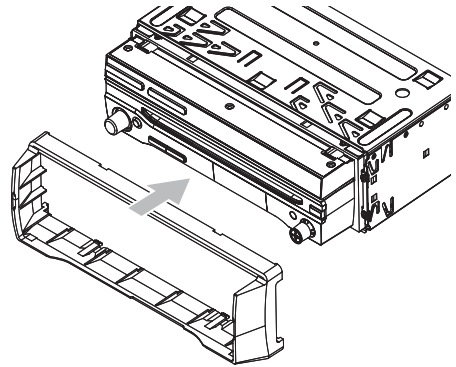

- 9 Reconnect the negative terminal of the car battery.

Install remote control battery

! Caution

- Risk of explosion! Keep batteries away from heat, sunshine or fire. Never discard batteries in fire.

≡ Note

- Remove batteries if they are exhausted or if the remote control is not to be used for a long time.
- Batteries contain chemical substances, they should be disposed of properly.
- Perchlorate Material - special handling may apply. See www.dtsc.ca.gov/hazardouswaste/perchlorate.

- 1 Open the battery compartment.
- 2 Insert 1 CR2025 battery with correct polarity (+/-) as indicated.
- 3 Close the battery compartment.

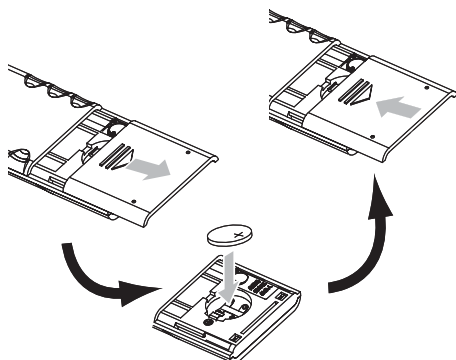

Turn on

! Caution

- Risk of road accidents! Never watch video or adjust settings while you drive.

- 1 Press **⏻** to turn on the unit.
 - ↳ The screen opens automatically.
 - ↳ The available OSD (On-Screen Display) languages are displayed.



- 2 Touch a language to select.
 - ↳ The OSD language is changed to the selected language immediately.
 - To adjust the screen tilt, press **▲ TILT ▼**.
 - To close the screen, press **OPEN/CLOSE**.
 - To adjust the brightness/contrast, press **⊗/⊕**, then adjust **4WAY NAVIGATION**.
 - To turn off the unit, press **⏻** for 3 seconds.
 - ↳ The screen closes automatically.

Set clock

- 1 Touch **↶** to display main menu.



- 2 Touch **[Settings]**.
 - ↳ The setup menu is displayed.



- 3 Touch **[General]**.
- 4 Touch **[Clock mode]** repeatedly to select:
 - **[12hr]** : 12 hour mode
 - **[24hr]** : 24 hour mode
- 5 Touch the hour digits, then touch **+** or **-**.
- 6 Touch the minute digits, then touch **+** or **-**.
- 7 If 12 hour mode is selected, touch **+** or **-** to select **[AM]** or **[PM]**.
- 8 Touch **↶** to exit.

4 Listen to radio

Tune to a radio station

- 1 Touch **[Home]** to display the main menu.
- 2 Touch **[Radio]**.
 - ↳ Band and frequency information is displayed.



- 3 Touch **[Band]** repeatedly to select:
 - FM band options: **[FM1]**, **[FM2]**, **[FM3]**
 - AM band options: **[AM1]**, **[AM2]**
- 4 Briefly touch **[Previous]** or **[Next]** to tune to a radio station by step.
 - Touch **[Previous]** or **[Next]** for over 1 seconds to tune to a radio station automatically.

Tune by frequency

- 1 Touch **[Band]** to select band.
- 2 Touch **[Tune]**.
 - ↳ The manual tune menu is displayed.



- 3 Touch the numbers to enter frequency.
 - Touch **[Back]** to clear the last entered number.

- Touch **[Clear]** to clear all the entered numbers.

- 4 Touch **[Enter]** to save.
 - ↳ The radio station is broadcast.

Scan search

You can search for a station with intro search, which broadcasts a 10-second preview of each detected radio station.

- 1 Touch **[Band]** to select band.
- 2 Press **INTRO.SCH** on the main unit.

Select tuner sensitivity

Before you start to search for radio stations, you can select tuner sensitivity.

- **[Normal]**: Only stations with strong signals can be broadcast.
- **[HiSens]**: Stations with strong and weak signals can be broadcast.

- 1 Touch **[HiSens]** to toggle tuner sensitivity from normal to high sensitivity.
 - ↳ The display is changed.
 - ↳ To change tuner sensitivity back to normal, touch **[Normal]**.

Store radio stations in memory

You can store up to 6 stations in each band.

Store stations automatically

- 1 Touch **[Home]** to display the main menu.
- 2 Touch **[Radio]**.
- 3 Touch **[Band]** repeatedly to select band.
- 4 Touch **[Search]**.
 - ↳ Auto search starts. The six strongest stations of the selected band are saved in preset channels 1-6 automatically.

Store stations manually

- 1 Tune to the station (see 'Tune to a radio station' on page 18).
- 2 Touch **[Save]**.
 - ↳ The preset stations are displayed.



- 3 Touch one of the preset stations.
 - ↳ The station is saved in the selected preset number.

Tune to a preset station

- 1 Touch **[Radio]**.
- 2 Touch **[Band]** to select band.
- 3 Touch ▲ or ▼ to select a preset station.

5 Play

Load discs

You can play video, audio or images stored on the following discs:

- DVD video, DVD-R, DVD-RW
- VCD
- Audio CD, CD-R, CD-RW

Note

- Ensure that the disc contains playable content.

- 1 Insert the disc into the disc slot with label side facing up.
↳ Play starts automatically.

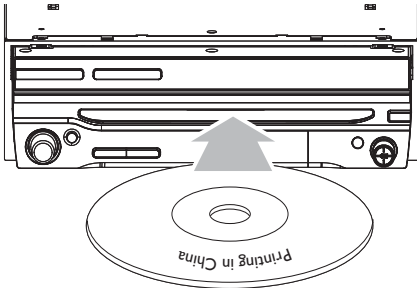

- ↳ To remove the disc, press the ▲ button.
- ↳ When the disc is ejected, the unit switches to the previous source, if connected. Otherwise, the unit switches to **[Radio]** mode automatically.

Insert USB or SD/MMC card

Note

- Ensure that the device contains playable content.
- The unit supports SDHC card.

- 1 Open the USB/SD/MMC card cover.

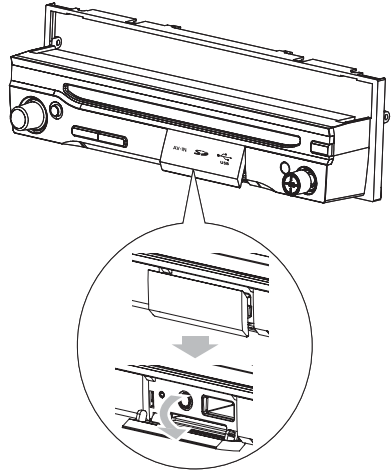

- 2 Insert the USB device or SD/MMC card into the USB socket or SD/MMC card slot.
↳ Play starts automatically.

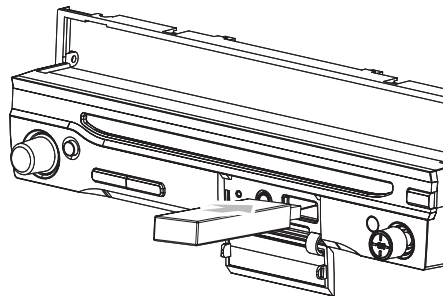

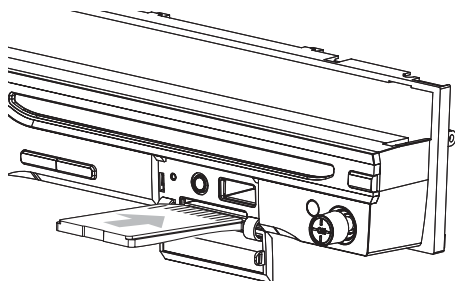

Remove the USB device

- 1 Press **SOURCE** to switch to another source.
- 2 Remove the USB device.

Remove the SD/MMC card

- 1 Press **SOURCE** to switch to another source.
- 2 Press the card until you hear a click sound.
↳ The card is now disengaged.
- 3 Remove the SD or MMC card.

Play/Pause

- 1 Once the disc, USB or SD/MMC card is inserted, play starts automatically.
For DVD movie, if a menu appears, press to start play.

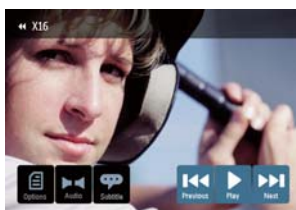

- 2 To pause, touch **||**.
 - To resume play, touch **||** again.
- 3 To stop, press **■** on the remote control.

Search for a folder

For video files

- 1 Touch **↶** to return to playlist menu.
- 2 Touch **📁** to display all available video file folders.
- 3 Touch a folder; then touch **[Select]**.
- 4 Touch a video file to select, then touch **▶** to start play.

For audio files

- 1 Touch **↶** to return to playlist menu.
- 2 Touch **📁** to display all available audio folders.
- 3 Touch a folder; then touch **[Select]**.
- 4 Touch an audio file to select, then touch **▶** to start play.

For picture files

- 1 Touch **↶** to return to playlist menu.
- 2 Touch **📁** to display all available picture folders.
- 3 Touch a folder; then touch **[Select]**.
- 4 Touch a picture file to select, then touch **▶** to start play.

Search within a title/folder

Search by step

- 1 Touch anywhere except for the upper left corner to display menu on the screen, if necessary.
- 2 Touch **[Previous]** or **[Next]** to skip to the previous or next chapter/track.

Direct search

- 1 Touch anywhere except for the upper left corner to display menu on the screen, if necessary.
- 2 Touch **[Goto]**.
↳ The search screen is displayed.



↳ For video files, touch **[Options]** first, then touch **[Goto]**.

- 3 Touch the numbers to enter chapter/file number; then touch **[Enter]**.

Repeat

During play, you can select different repeat play modes.

For DVD/VCD movie disc:

- 1 Touch anywhere except for the upper left corner to display menu on the screen, if necessary.
- 2 Touch **[Options]** >  to select:
 - **[Repeat chapter]**: play the current chapter repeatedly.
 - **[Repeat title]**: play all chapters in the title repeatedly.
 - **[Repeat off]**: cancel repeat play.

For VCD karaoke or audio CD:

- 1 Touch anywhere except for the upper left corner to display menu on the screen, if necessary.
- 2 Touch  to select:
 - **[Repeat 1]**: play the current track repeatedly.
 - **[Repeat off]**: cancel repeat play.

For MP3/WMA files:

- 1 Touch anywhere except for the upper left corner to display menu on the screen, if necessary.
- 2 Touch  to select:
 - **[Repeat 1]**: play the current track repeatedly.
 - **[Repeat folder]**: play all the tracks in the current folder repeatedly.

- **[Repeat off]**: cancel repeat play.



Tip

- You can also press **REPT** on the remote control to select repeated play mode.

Repeat a section

You can repeat a specific section of video file (repeat A-B).

- 1 During play, touch anywhere except for the upper left corner to display menu on the screen, if necessary.
- 2 Touch **[Options]**.
- 3 Touch **A-B** repeatedly to mark:
 - **[Repeat A-]**: the start of the section to repeat.
 - **[Repeat A-B]**: the the end of the section to repeat.
 - The selected section plays repeatedly.
- 4 To exit A-B repeat mode, touch **A-B** repeatedly until **[Repeat A-B off]** is displayed.



Tip

- You can also press **A-B** on the remote control to set A-B repeat play.

Random play

You can play audio tracks/files in random order.

- 1 During play, touch  repeatedly to select:
 - **[Shuffle on]** : start random play.
 - **[Shuffle off]** : cancel random play.



Tip

- You can also press **SHUFF** on the remote control to select random play mode.

Select audio language

For video discs that contain two or more audio channels.

- 1 During play, touch anywhere except for the upper left corner to display menu on the screen, if necessary.
- 2 Touch **[Channel]** repeatedly.
 - ↳ The audio channel information is displayed on the upper line of the screen.



Tip

- You may also press **DISC AUDIO** on the remote control repeatedly to select audio channel.

Select audio mode

When you play VCDs/CDs, you can select an audio mode (R/L/Stereo).

- 1 During play, touch anywhere except for the upper left corner to display menu on the screen.
- 2 Touch **[Audio]** repeatedly until the audio mode is selected.

Select subtitle language

For DVD or DivX discs that contain two or more subtitle languages.

- 1 During play, touch anywhere except for the upper left corner to display menu on the screen, if necessary.

- 2 Touch **[Subtitle]** repeatedly to select a language.
 - ↳ The selected language is displayed.



Tip

- You may also press **SUBTITLE** on the remote control repeatedly to select subtitle language.

Change view angle

Some DVDs contain alternate scenes, such as scenes recorded from different camera angles. For such DVDs, you can select from the available alternate scenes.

- 1 During play, touch anywhere except for the upper left corner to display menu on the screen, if necessary.
- 2 Touch **[Options]**.
- 3 Touch **[Angle]**.
 - ↳ The view angle is changed.



Tip

- You can also change view angle by pressing **ANGLE** on the remote control.

Rotate pictures

- 1 When you view pictures, touch anywhere except for the upper left corner to display menu on the screen, if necessary.
- 2 Touch **[Rotate]** repeatedly to rotate the picture.

Zoom

You can zoom in pictures for a close view.

- 1 During view pictures, touch anywhere except for the upper left corner to display menu on the screen, if necessary.
- 2 Touch **[Zoom]** repeatedly to zoom in the picture.



- 3 Touch ▲, ▼ or ◀▶ to pan through the enlarged picture.

Select slide show duration

- 1 Touch anywhere except for the upper left corner to display menu on the screen, if necessary.
- 2 Touch **[Duration]** repeatedly to select:
 - **[Duration]:** 3s (3 seconds)
 - **[Duration]:** 5s (5 seconds)
 - **[Duration]:** 8s (8 seconds)

6 Play with Bluetooth device

You can make or receive phone calls with Bluetooth-enabled phones through the unit. You can also listen to music from a Bluetooth-enabled device.

Pair the Bluetooth-enabled devices

The first you connect your Bluetooth device to the unit, you need to pair the device to the unit. Pairing needs only to be done once. You can pair up to eight devices.

Note

- The operational range between this unit and a Bluetooth device is approximately 10 meters (30 feet).
- Before you connect a Bluetooth device to this unit, familiarize yourself with the Bluetooth capabilities of the device.
- Compatibility with all Bluetooth devices is not guaranteed.
- Any obstacle between this unit and a Bluetooth device can reduce the operational range.
- Keep this unit away from any other electronic device that may cause interference.

- 1 Turn on the Bluetooth function on the device.
- 2 Setup the Bluetooth function on your device.
- 3 Select "CED750" in the pairing list.
- 4 Enter default password "0000".
↳ If pairing succeeds, [Connect] is displayed on the panel.

Disconnect Bluetooth devices

- 1 To disconnect one device, touch [Disconnected].
↳ [Connect] is displayed.

Tip

- The device will also be disconnected when the device is moved beyond the operational range.
- If you want to reconnect the device to the unit, place it within the operational range.
- If you do not want to reconnect the device to the unit automatically, touch [Settings] > [Auto connect], then select [Off]. For details, see the "Adjust Bluetooth settings" section.

Make a call

- 1 Pair the phone with the unit. (see 'Pair the Bluetooth-enabled devices' on page 25)
- 2 Touch ↶ to return to main menu.
- 3 Touch [Bluetooth].
↳ The Bluetooth menu is displayed.

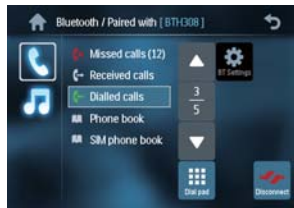

- 4 Touch ▲ or ▼ to select phone number from the following list:
 - [Dialed calls list]: dialed number
 - [Missed calls list]: missed call
 - [Received calls list]: received call
 - [Phone book list]: Phone directory
 - [SIM phonebook]: SIM directoryOr touch [Dial pad] to dial number directly.



- 5 Touch  to dial.

Receive call

By default, all incoming calls are received automatically. You can select to receive calls manually. (see 'Adjust Bluetooth settings' on page 29)

- 1 If there is incoming call, **[Incoming call...]** flashes on the screen. Speak into the Bluetooth microphone.
- 2 When conversation ends, touch  to terminate the call.

Switch phone call to the mobile



If you do not want your passenger to hear your incoming call, you can switch the call to the mobile.

- 1 During talking, touch  (**[Switch]**).
 - ↳ The voice is transferred from the unit's loudspeaker to the mobile phone.

Listen to music from Bluetooth device

If the connected Bluetooth device supports Advanced Audio Distribution Profile (A2DP), you can listen to the music stored on the device through the unit. If the device also supports Audio Video Remote Control Profile (AVRCP) profile, you can use the control on the unit or

its remote control to play music stored on the device.

- 1 Touch  to return to main menu.
- 2 Touch **[Bluetooth]**.
- 3 Touch .
- 4 Touch  to start play.

7 Adjust sound

Adjust volume

- 1 Turn \odot clockwise/anticlockwise to increase/decrease volume.

Mute

You can turn off the sound of your audio.

- 1 During play, press **MUTE** \odot .
 - To turn the sound back on, press **MUTE** \odot again.

Select preset equalizer

You can select preset equalizer:

- [User]
- [Techno]
- [Rock]
- [Classic]
- [Jazz]
- [Optimal]
- [Flat]
- [Pop]

- 1 Touch \rightarrow to display to menu.

- 2 Touch [EQ].
 - \hookrightarrow The current Equalizer setting is displayed.



- 3 Touch \blacktriangleleft or \blacktriangleright to select an EQ.
- 4 Touch \blacktriangle or \blacktriangledown to adjust below settings:
 - [Bas]bass range: -14 to +14

- [Mid]middle range: -14 to +14.
- [Tre]treble range: -14 to +14
- [LPF] low pass filter range: 60, 80, 100, 200.
- [MPF]middle pass filter range: 500, 1K, 1.5K, 2.5K.
- [HPF]high pass filter range:10K, 12.5K, 15K, 17.5K.

- 5 Press \rightarrow to exit.

Adjust fader/balance

You can also adjust the front and rear speaker balance, the left and right speaker balance, and subwoofer settings.

- 1 Touch \rightarrow to display menu.
- 2 Touch [FAD-BAL].
 - \hookrightarrow Below options are displayed:

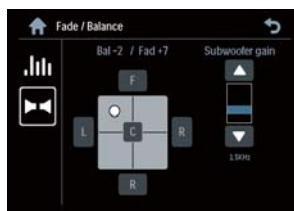

- 3 Touch \blacktriangle or \blacktriangledown repeatedly to select the item to be adjusted:
 - [Bal] balance range: 12L to 12R. (L = left speaker, R = right speaker)
 - [Fad]fader range: 12R to 12F. (R = rear speaker, F = front speaker)
 - [Sub.w] subwoofer volume: 0 to 24.
- 4 Touch \rightarrow to exit.

8 Adjust settings

Adjust general system settings

1 Touch  to display main menu.



2 Touch **[Settings]**.
↳ The settings menu is displayed.



3 Touch **[General]**.

4 Touch an option repeatedly to select:

System settings	Options	Description
[Clock mode]	[12hr]	12-hour mode.
	[24hr]	24-hour mode.
[Time]		Set clock.
[LCD panel open]	[Auto]	Open/close screen automatically when the system is turn on/off.
	[Manual]	Press OPEN/CLOSE to open or close screen.
[Beep]	[On]	Turn on the beep sound. Each time you press a button, the unit beeps.
	[Off]	Turn off the beep sound.
[Calibration]		Calibrate the touch screen.
[Radio range]	[Local]	Only stations with strong signals can be broadcast.
	[Distance]	Stations with strong and weak signals can be broadcast.
[Blackout]	[10s]	Turn on the screen saver automatically 10 seconds after last operation.
	[20s]	Turn on the screen saver automatically 20 seconds after last operation.
	[Off]	Never turn on the screen saver.
[Key color]	[Red]	Button backlight turns red.
	[Blue]	Button backlight turns blue.

5 Press  to exit.

Adjust sound settings

- 1 Touch  to display main menu.
- 2 Touch **[Settings]**.
- 3 Touch **[Sound]**.
- 4 Touch an option repeatedly to select:

Sound settings	Options	Description
[Sub.w]	[On]	Turn on the subwoofer.
	[Off]	Turn off the subwoofer.
[Sub.w filter]	[80 Hz]	Select subwoofer filter criteria.
	[120 Hz]	
	[160 Hz]	
[DBB]	[DBB on]	The Dynamic Bass Boost (DBB) function is on.
	[DBB off]	The DBB function is off.
[DRC]	[On]	Makes loud sound level softer and soft sound level louder so that you can watch the DVD movies at a low volume, without disturbing others
	[Off]	The DRC function is off.

- 5 Press  to exit.

Adjust video settings

- 1 Touch  to display main menu.
- 2 Touch **[Settings]**.
- 3 Touch **[Videos]**.
- 4 Touch an option repeatedly to select:

Video settings	Options	Description
[Aspect ratio]	[Wide]	For widescreen display.
	[Normal]	For normal display.
[Video input]	[Auto]	The correct format is set automatically. Select this option if you are not sure which format should be selected.
	NTSC	Used in the United States, Canada, Japan, Mexico, the Philippines, South Korea, Taiwan, and some other countries.
	PAL	Used in China, India, Singapore, the western European countries (except France), Australia, and some other countries.
	SECAM	Used in France, Russia and other countries.
[Rear camera]	[Normal]	When you drive in reverse, the rear view is displayed normally.
	[Mirror]	When you drive in reverse, the rear view is displayed in mirror.
[Parking]	[On]	Disable video view when you drive.
	[Off]	Enable video view when you drive.
[DivX (R) reg code]		View code for DivX registration.

- 5 Press  to exit.

Adjust Bluetooth settings

- 1 Touch  to display main menu.
- 2 Touch **[Settings]**.
- 3 Touch **[Bluetooth]**.

- 4 Touch an option repeatedly to select:

Bluetooth settings	Options	Description
[Bluetooth]	[On]	Turn on the Bluetooth function.
	[Off]	Turn off the Bluetooth function.
[Auto connect]	[On]	If the pre-paired device is within the effective range, the unit re-connects to pre-paired device automatically.
	[Off]	Need to re-connect manually.
[Auto answer]	[On]	Answer paired phone call automatically.
	[Off]	Answer hone call manually.
[Pairing code]		View code for pairing the unit with other Bluetooth devices.

- 5 Press ↵ to exit.

Adjust language settings

- 1 Touch ↵ to display main menu.
- 2 Touch [Settings].
- 3 Touch [Language].
- 4 Touch an option repeatedly to select:

Language settings	Options	Description
[OSD]	[English]	Select on-screen-display language.
	[Spanish]	
	[Portuguese]	
[DVD audio]	[English]	Select DVD audio language. Options available are depends on DVD disc.
	[Spanish]	
	[Portuguese]	
[DVD subtitle]	[English]	Select DVD subtitle language. Options available are depends on DVD disc.
	[Spanish]	
	[Portuguese]	
	[Off]	Turn off subtitle language display.
[Disc menu]	[English]	Select DVD menu language. Options available are depends on DVD disc.
	[Spanish]	
	[Portuguese]	

- 5 Press ↵ to exit.

Adjust volume settings

If you want to listen to music more louder but do not want radio to be so loud, you can adjust them individually by this settings.

- 1 Touch ↵ to display main menu.
- 2 Touch [Settings].
- 3 Touch [Volume].
 - ↳ The volume setting sub-menu is displayed.
- 4 Touch an option to select a source.

- 5 Touch ▲ or ▼ to assign value: 0 to 12.
 ↳ When switches to the source, the volume will increase or decrease accordingly.
- 6 Press ↵ to exit.

Adjust DVD rating

- 1 Touch ↵ to display main menu.
- 2 Touch [Settings].
- 3 Touch [DVD rating].
- 4 Touch an option repeatedly to select:

DVD rating	Options	Description
[Set password]		Set password to restrict the play of discs. The default password is 0000.
[Rating]	[1. Kid safe]	Acceptable for children.
	[2. G]	Acceptable for general viewers.
	[3. PG]	Parental guidance suggested.
	[4. PG-13]	Unsuitable for children under age 13.
	[5. PG-R]	Recommend parents to restrict children under 17 to view.
	[6. R]	Restricted. Recommend parent to guide children under 17 to view.
	[7. NC-17]	Unsuitable for children under age 17.
	[8. Adult]	Acceptable for adults only.
[Load factory]		Restore to default settings.

- 5 Press ↵ to exit.

9 Others

Listen to other devices

You can connect an external audio/video device to the unit.

- 1 Connect the device to the unit with the supplier AV cable.

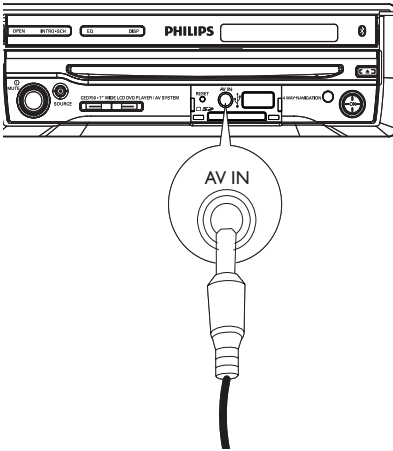

- 2 Touch  to display main menu.
- 3 Touch [AV IN].
- 4 Begin play on the device (see the device instructions).

Reset

When the unit hangs up, you can reset it.

- 1 Press **RESET** with a ball-point pen or similar tool.

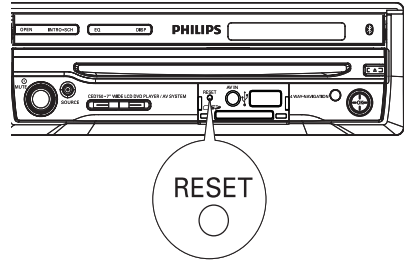

Tip

- When the unit is reset, all the settings remains unchanged.

Remove the unit

To repair, replace fuse, or replace the unit with another car audio, remove it from the dashboard.

- 1 Take off the trim plate.
- 2 Screw off the four (4) screws on the left/right side of the unit.
- 3 Pull the unit out from the dashboard.

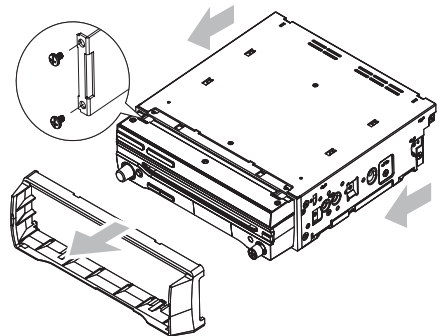

Replace fuse

If there is no power, the fuse may be damaged and need to be replaced.

- 1 Take out the unit from dashboard.
- 2 Check the electric connection.
- 3 Buy a fuse that matches the voltage of the damaged fuse (15A)
- 4 Replace the fuse.

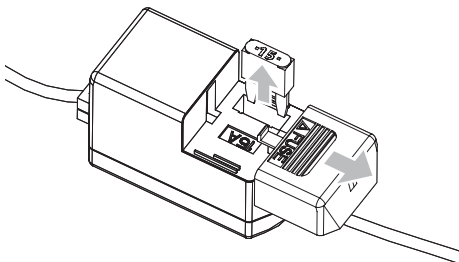

If the fuse gets damaged immediately after it has been replaced, there may be an internal malfunction. In such case, consult your Philips dealer.

10 Product information

Note

- Product information is subject to change without prior notice.

General

Power supply	12 V DC (11 V - 16 V), negative ground
Fuse	15 A
Suitable speaker impedance	4 - 8 Ω
Maximum power output	50 W x 4 channels
Continuous power output	24 W x 4 channels (4 Ω 10% T.H.D.)
Pre-Amp output voltage	2.0V (CD play mode; 1 kHz, 0 dB, 10 k Ω load)
Subwoofer output voltage	2.0V (CD play mode)
Aux-in level	\geq 500 mV
Dimensions (W x H x D)	188 x 58 x 203 mm
Weight (main unit)	2.5 kg

Disc player

System	Disc digital audio system
Frequency response	20 Hz - 20k Hz
Signal/noise ratio	>75dB
Total harmonic distortion	Less than 0.30% (1K Hz)
Channel separation	>55dB
Video signal format	NTSC
Video output	1 +/- 0.2V

Tuner

Frequency range - FM	87.5 - 108.0 MHz (Europe) 65.0 - 74.0 MHz.(OIRT) 87.5 - 107.9 MHz (American)
Frequency range - AM(MW)	522 - 1620 KHz (Europe) 530 - 1710 HKz (American)
Usable sensitivity - FM	8 uV
Usable sensitivity - AM(MW) (S/N = 20 dB)	30 uV
Frequency response	30 Hz - 15 KHz
Stereo separation	30 db (1 kHz)
Signal/noise ratio	>55 dB

LCD

Screen size	7 inches (16:9)
Display resolution	480 x 234 dots
Active area	154.08 x 86.58 mm
Dot pitch	0.107 x 0.370 mm
Contrast ratio	350
Brightness	200 cd/m

Bluetooth

Communication system	Bluetooth Standard version 2.0
Output	Bluetooth Standard Power Class 2
Maximum communication range	Line of sight approx.10m
Frequency band	2.4 GHz band (2.4000 GHz - 2.4835 GHz)
Modulation method	FHSS
Compatible Bluetooth profiles	Hands-Free Profile (HFP) Hands-Free Profile (HFP) Advanced Audio Distribution Profile (A2DP) Audio Video Remote Control Profile (AVRCP)
Supported codecs	
Receive	SBC (Sub Band Codec), MP3
Transmit	SBC (Sub Band Codec)

Compatible USB devices:

- USB flash memory (USB 2.0 or USB1.1)
- USB flash players (USB 2.0 or USB1.1)
- memory cards

Supported formats:

- USB or memory file format FAT12, FAT16, FAT32 (sector size: 512 bytes)
- MP3 bit rate (data rate): 32-320 Kbps and variable bit rate
- WMA v9 or earlier
- Directory nesting up to a maximum of 8 levels
- Number of albums/ folders: maximum 99
- Number of tracks/titles: maximum 999
- ID3 tag v2.0 or later
- File name in Unicode UTF8 (maximum length: 128 bytes)

Unsupported formats:

- Empty albums: an empty album is an album that does not contain MP3/ WMA files, and is not be shown in the display.

- Unsupported file formats are skipped. For example, Word documents (.doc) or MP3 files with extension .dlf are ignored and not played.
- AAC, WAV, PCM audio files
- DRM protected WMA files (.wav, .m4a, .m4p, .mp4, .aac)
- WMA files in Lossless format

Supported MP3 disc formats:

- ISO9660, Joliet
- Maximum title number: 512 (depending on file name length)
- Maximum album number: 255
- Supported sampling frequencies: 32 kHz, 44.1kHz, 48 kHz
- Supported Bit-rates: 32~256 (kbps), variable bit rates

Supported video formats

- DivX
- MP4
- Xvid

Note

- To ensure a better playback, bit rate of 4.5 Mbps is recommended.

11 Troubleshooting



Caution

- Never remove the casing of this unit.

To keep the warranty valid, never try to repair the system yourself.

If you encounter problems when using this unit, check the following points before requesting service. If the problem remains unsolved, go to the Philips web site (www.Philips.com/support). When you contact Philips, ensure that your unit is nearby and the model number and serial number are available (see 'Get started' on page 10).

No power

- Car engine has not been started. Start the car engine.
- Connections is incorrect.
- Fuse has been damaged. Replace fuse (see 'Replace fuse' on page 33).

No sound

- Volume is too low. Adjust volume.
- Speaker connections is incorrect.

No response to the remote control

- Ensure that the path between the remote control and the unit is clear from obstacles.
- From a close distance, point the remote control directly at the unit.
- Replace the remote control battery.
- The function does not work. Refer to the instructions.

Disc does not play

- Disc is upside down. Ensure the printed side is upwards.
- Disc is dirty. Clean the disc with a clean, soft, lint-free cloth. Wipe the disc outwards from the center.
- Disc is defective. Try another disc.
- incompatible disc is used. Try another disc.
- Disc rating exceeds the restrict setting. Change the rating settings to lower one.

- Disc region code is not compatible with the unit. Use disc with proper region code.

No image

- Parking brake wire connection is incorrect. Check the parking wiring. (see 'Connect parking brake wire' on page 14)

Image flashes or distorted

- Video DVD settings do not match with the DVD. Adjust video DVD settings.
- Video connection is improper. Check the connections.

Noise in broadcasts.

- Signals are too weak. Select other stations with stronger signals.
- Check the connection of the car antenna.
- Change broadcast from stereo to mono.

Preset stations lost.

- Battery cable is not correctly connected. Connect the battery cable to the terminal that is always live.

Fuse is broken

- The Fuse type is incorrect. Replace it with a 15A fuse.
- Speaker wire or power wire is grounded. Check the connections.

Display show ERR-12

- USB/SD/MMC data error: Check the USB device or SD/MMC card.

About Bluetooth device

Music playback is unavailable on the system even after successful Bluetooth connection.

- The device cannot be used with the system to play music.

The audio quality is poor after connection with a Bluetooth-enabled device.

- The Bluetooth reception is poor: Move the device closer to the unit or remove any obstacle between the device and the unit.

Cannot connect with the unit.

- The device does not support the profiles required for the unit.
- The Bluetooth function of the device isn't enabled. Refer to the user manual of the device for how to enable the function.

- The unit is not in the pairing mode.
- The unit is already connected with another Bluetooth-enabled device. Disconnect that device or all other connected devices and then try again.

The paired mobile phone connects and disconnects constantly.

- The Bluetooth reception is poor. Move the mobile phone closer to the unit or remove any obstacle between the mobile phone and the unit.
- Some mobile phones may connect and disconnect constantly when you make or end calls. This does not indicate any malfunction of the system.
- For some mobile phones, the Bluetooth connection may be deactivated automatically as a power-saving feature. This does not indicate any malfunction of the system.

12 Glossary

B

Bite rate

The max data transfer through the USB port.

Bluetooth

Bluetooth® is a short-rang wireless protocol that is meant to allow mobile devices to share information and applications without the worry of cables or interface incompatibilities. The name refers to a Viking King who unified Denmark. Operate at 2.4GHz. For more information, see www.Bluetooth.com.

M

MMC

MultimediaCard. A type of memory card with a flash memory.

MP3

A file format with a sound data compression system. MP3 is the abbreviation of Motion Picture Experts Group 1 (or MPEG-1) Audio Layer 3. With the MP3 format, one CD-R or CD-RW can contain about 10 times more data than a regular CD.

R

Region code

A system that allows discs to be played only in the region designated. This unit only plays discs that have compatible region codes. You can find the region code of your unit on the product label. Some discs are compatible with more than one region (or ALL regions.)

S

SD

Secure Digital. A type of memory card with a flash memory.

SDHC

Secure Digital High Capacity (SDHC) is a type of flash memory card based on the SDA 2.00 specification. The SDA 2.00 specification enables SD cards to reach higher capacities from 4GB to 32GB, and growing.

W

WMA (Windows Media Audio)

An audio format owned by Microsoft, is a part of Microsoft Windows Media technology. Includes Microsoft Digital Rights Management tools, Windows Media Video encoding technology, and Windows Media Audio encoding technology.

