

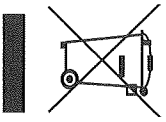

# **NA87**

---

Car Audio System Player  
**INSTRUCTION MANUAL**



[www.nakamichicaraudio.com](http://www.nakamichicaraudio.com)

**MP3 WMA USB SD AUX-IN BT  
1A USB Universal Charge**

## Safety

### WARNING

Stop the car before operating the unit.

### Important to know...

- ★ To prevent a short circuit, never put or leave any metallic objects (such as coins or metal tools) inside the unit.
- ★ **Caution:** Adjust the volume so that you can hear sounds outside the car. Driving with the volume too high may cause an accident.
- ★ **Condensation:** When the car is air-conditioned, moisture may collect on the laser lens. This may cause disc read errors. In this case, remove the disc and wait for the moisture to evaporate.
- ★ The illustrations in this manual are examples used to explain more clearly how the controls are used. Therefore, what appears on the illustrations may differ from what appears on the actual equipment.
- ★ If you experience problems during installation, consult your Nakamichi dealer.
- ★ When you purchase external components, check with your Nakamichi dealer to make sure that they work with your model and in your area.

### Maintenance

Cleaning the unit: Wipe off the dirt on the panel with a dry silicon or soft cloth. Failure to observe this precaution may result in damage to the monitor or unit.

Cleaning the connector: Wipe off dirt on the connector of the unit and faceplate. Use a cotton swab or cloth.

### FCC STATEMENT

- ★ This device complies with Part 15 of the FCC Rules. Operation is subject to the following two conditions:
  - (1) This device may not cause harmful interference.
  - (2) This device must accept any interference received, including interference that may cause undesired operation.
- ★ Changes or modifications not expressly approved by the party responsible for compliance could void the user's authority to operate the equipment.

## Preparation

### How to attach/detach the faceplate

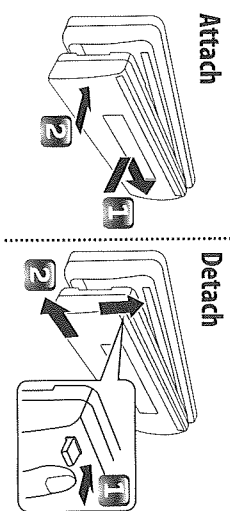

- ★ Do not expose the faceplate to direct sunlight, excessive heat, or humidity. Also avoid places with too much dust or the possibility of water splashing.
- ★ Keep the faceplate in its casing while detached.
- ★ The faceplate is a precision piece of equipment and can be damaged by shocks or jolts.
- ★ To prevent deterioration, do not touch the terminals of the unit and faceplate with your fingers.

### How to reset your unit

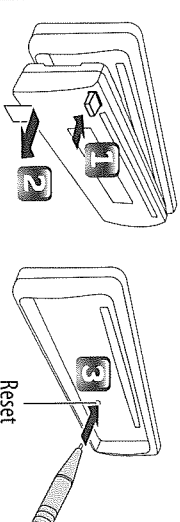

- ★ If this unit fails to operate properly, press the reset button.
- ★ The unit returns to factory settings when the reset button is pressed.

## What's in the box

Check and identify the contents of your package:

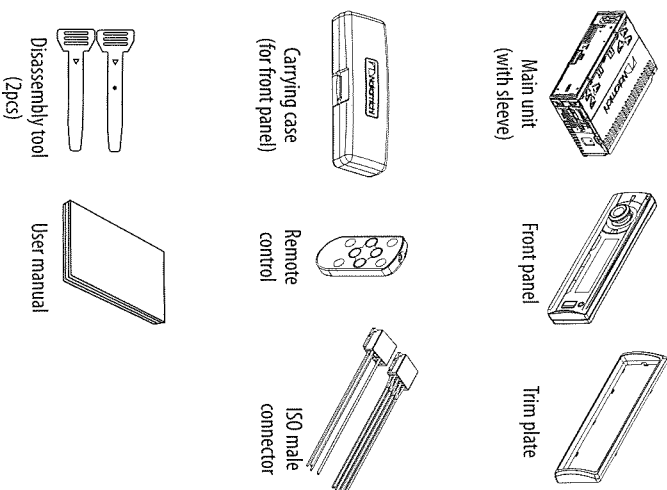

# Installation / Connection

## Basic Procedure

- 1 Remove the key from the ignition switch, then disconnect the ⊖ terminal of the car battery.
- 2 Make proper input and output wire connections.
- 3 Install the unit to your car.
- 4 Reconnect the ⊖ terminal of the car battery.
- 5 Reset the unit.

## Warning

- ★ The unit can only be installed in a car with a 12V DC power supply, negative ground.
- ★ If you connect the ignition wire (red) and the battery wire (yellow) to the car chassis (ground), you may cause a short circuit, that in turn may start a fire. Always connect those wires to the power source running through the fuse box.
- ★ Disconnect the battery's negative terminal and make all electrical connections before installing the unit.
- ★ Insulate unconnected wires with vinyl tape or other similar material. To prevent a short circuit, do not remove the caps on the ends of the unconnected wires or the terminals.
- ★ Be sure to ground this unit to the car's chassis again after installation.
- ★ If the power is not turned ON, the speaker wire may have a short-circuit or touched the chassis of the vehicle and the protection function may have been activated. Therefore, the speaker wire should be checked.

## Caution

- ★ If your car's ignition does not have an ACC position, connect the ignition wires to a power source that can be turned on and off with the ignition key. If you connect the ignition wire to a power source with a constant voltage supply, as with battery wires, the battery may die.
- ★ Install this unit in the console of your vehicle. Make sure the faceplate will not hit the lid of the console (if any) when closing and opening.
- ★ After the unit is installed, check whether the brake lamps, blinkers, wipers, etc. on the car are working properly.
- ★ Mount the unit so that the mounting angle is 30° or less.
- ★ If the fuse blows, first make sure the wires are not touching to cause a short circuit, then replace the old fuse with one that has the same rating.
- ★ Connect the speaker wires correctly to the terminals to which they correspond. The unit may be damaged or fail to work if you share the ⊖ wires or ground them to any metal part in the car.
- ★ When only two speakers are being connected to the system, connect the connectors either to both the front output terminals or to both the rear output terminals (do not mix front and rear).
- ★ Mounting and wiring this product requires skills and experience. For safety's sake, leave this work to professionals. If you experience problems during installation, consult your Nakamichi dealer.

## Wiring Connection

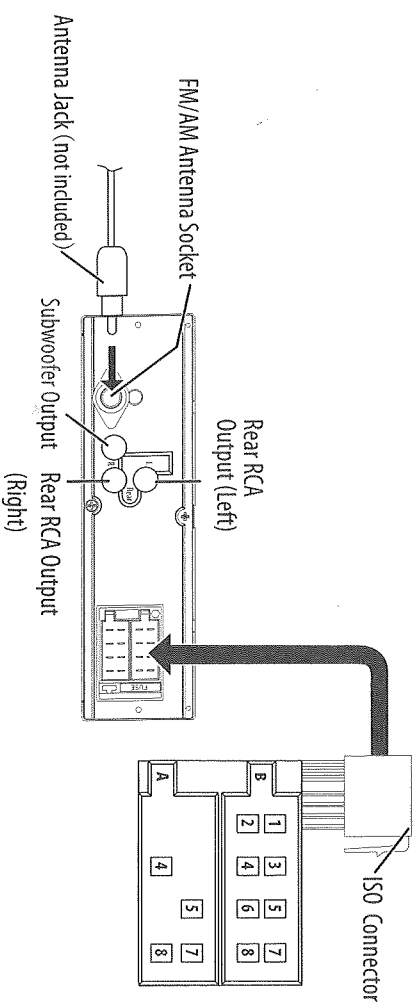

## ISO Connector Wiring Chart

Pin	Color and function	Pin	Color and function
A4	Yellow Battery(+)	B1/B2	Violet ⊕ / Violet/Black ⊖
A5	Blue Connect to system control terminal of the power AMP or auto antenna relay/control terminal (Max 150mA 12VDC)	B3/B4	Grey ⊕ / Grey/Black ⊖
A7	Red Ignition (ACC)	B5/B6	White ⊕ / White/Black ⊖
A8	Black Ground	B7/B8	Green ⊕ / Green/Black ⊖
			Left front speaker
			Left rear speaker

## Installing the unit

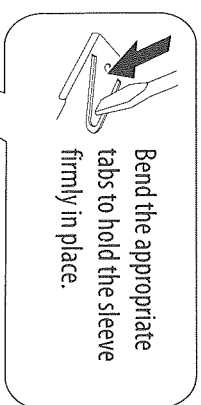
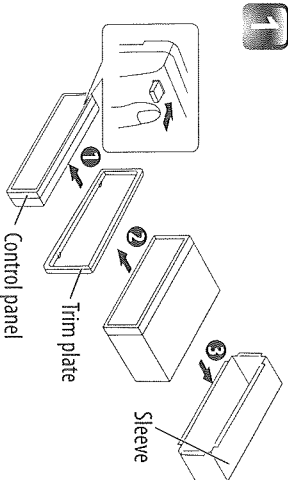

Before attaching, make sure the direction of the escutcheon is correct. (Wider hooks on the bottom side.)

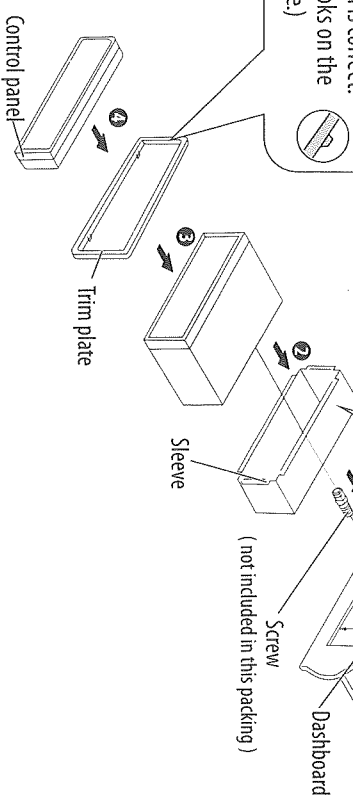

## Removing the unit

- 1 Detach the control panel.
- 2 Engage the catch pin on the removal tools into the holes on both sides of the escutcheon, then pull it out.
- 3 Insert the disassembly tools deeply into the slots on each side, then follow the arrows' instructions as shown on the right.

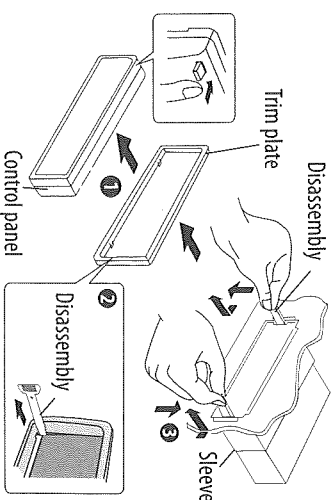

## Basic Operation

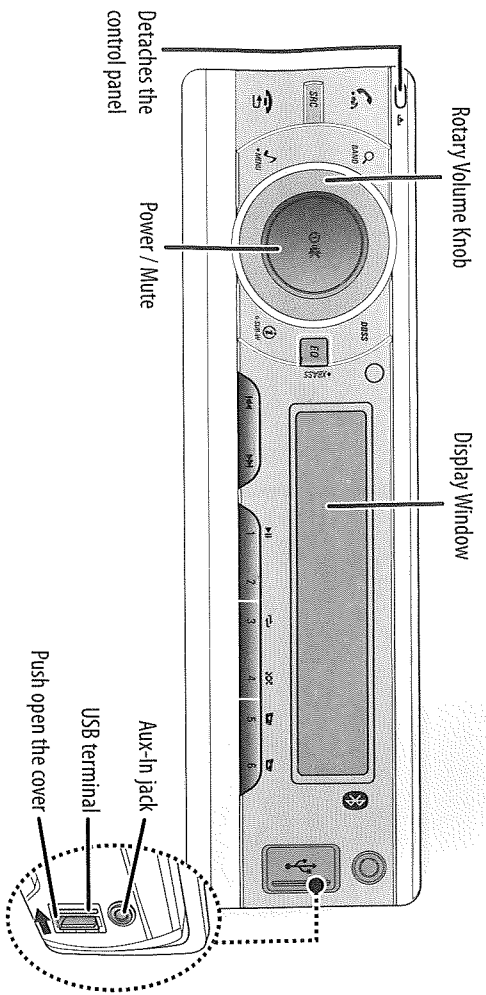

### When you press or hold the following button(s)...

Main unit	General operation
<b>SRC</b>	Select the available sources (Radio, USB, SD, BT AUDIO or MP3-LINK), if the power is turned on.
Rotary Volume knob	Rotate it to increase or decrease the volume.
Power / Mute	<ul style="list-style-type: none"> <li>■ Select items.</li> <li>■ Turn mute or restore volume.</li> <li>■ Turn the unit on. Press and hold again to turn the unit off.</li> <li>■ Confirms selection.</li> </ul>
<b>BAND</b>	<ul style="list-style-type: none"> <li>■ Select the FM bands (FM1/ FM2/ FM3) or AM1 (MW1) / AM2 (MW2).</li> <li>■ Under media playback to access into search mode.</li> <li>■ Press and hold to activate the Auto Store function.</li> </ul>
<b>1▶  </b>	Pause/resume playback of a USB / SD device.
<b>⏮/▶▶1</b>	<ul style="list-style-type: none"> <li>■ Under Radio mode to enter into the Auto Seek mode; press and hold to enter into the Manual Seek mode.</li> <li>■ Under Media playback mode to skip track / file; press and hold to fast forward / backward.</li> </ul>
<b>√ MENU</b>	To access into the Audio Menu mode; press and hold to enter into the System Menu mode.
<b>DBSS</b>	Turn On or Off dynamic bass boost sound.
<b>Ⓜ SUB-W</b>	<ul style="list-style-type: none"> <li>■ Press to view the Clock. Press &amp; hold to turn On or Off the Subwoofer function.</li> <li>■ Under Media playback mode to view play informations.</li> </ul>
<b>EQ / XBASS</b>	<ul style="list-style-type: none"> <li>■ To adjust the EQ (Preset Equalizer) setting.</li> <li>■ Turn On or Off the Xbass booster function.</li> </ul>
<b>📞</b>	<ul style="list-style-type: none"> <li>■ To answer / accept the call.</li> <li>■ During the talking, press and hold to transfer the call.</li> </ul>
<b>📶/📵</b>	<ul style="list-style-type: none"> <li>■ To reject / end the call.</li> <li>■ Returns to the previous item.</li> </ul>

## Function Settings

- 1 Press **√ MENU** to access into the [AUDIO MENU] mode; press and hold to enter into the [MENU] mode.
- 2 Press **√ MENU** repeatedly to select the item to be adjusted.
- 3 Turn the encoder volume knob to select a value / option.

### [AUDIO MENU] ...

Item	Selectable Setting
BASS ADJUST	
BASS LEVEL	Adjust the level -7 to +7.
TREBLE ADJUST	
TREBLE LEVEL	Adjust the level -7 to +7.
BALANCE	Adjust the balance between the right and left speakers from 10R (full right) to 10L (full left).
FADER	Adjust the fader between the front and rear speakers from 10R (full rear) to 10F (full front).

### [MENU] ...

Item	Selectable Setting
CLOCK	
CLOCK SET	Adjust the Hours and Minutes
CLOCK FORMAT	Select the time format 12H or 24H
BEEP TONE	Turn On or Off this beep sound

## Listening to the Radio

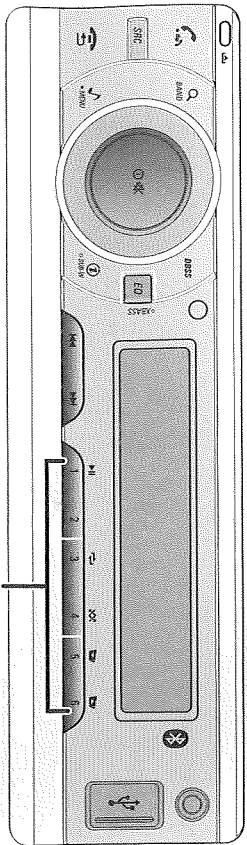

- Hold for about 2 seconds to memorize the current station.
- Press briefly to recall memorized station.

- 1 Press **BAND** repeatedly to a band (FM1, FM2, FM3, AM1 (MW1) or AM2 (MW2)). Press and hold to activate the Auto Store function.

- 2 Press **1/2/3/4/5/6** to search for a station.

### Adjust [MENU] mode settings

While listening to the radio...

- 1 Press and hold **MENU** to enter into the [MENU] mode.
- 2 Press **MENU** repeatedly to select the item to be adjusted.
- 3 Turn the encoder volume knob to select a value / option.

Item	Selectable Setting
LOC ON/OFF	To receive more radio stations or only stations with strong signal, you can adjust the radio sensitivity. <ul style="list-style-type: none"> <li>■ ON: Search for radio stations with strong signals only.</li> <li>■ OFF: Search for radio stations with strong and weak signals.</li> </ul>
STORE ↵	Press the <b>OK</b> to access into Auto Store mode, the six strongest stations of the selected band are saved in preset channel automatically: FM1, FM2, FM3(1-6), AM1, AM2.
AREA	Select suitable country region of the radio: USA; LATIN; EUROPE; RUSSIA(Ort); M-EAST; ASIA; JAPAN; AUST (Australia)

## Listening to a USB/SD device

- Detaches the control panel
  - Press to select a track / file.
  - Press and hold for fast forward / backward.
- Press to repeat one track, press again repeat a folder.
- USB terminal

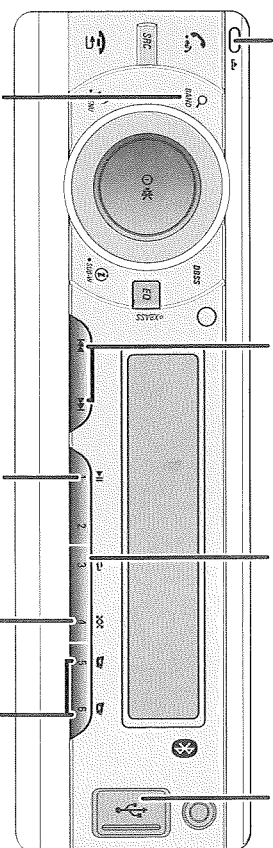

- Press into search mode
- Press to pause. Press again to resume playback.
- Press to move next/previous folder.

Press to start random play, press again to random a folder.

### Playing a USB device

- 1 Slide the USB socket cover market to the left.
- 2 Insert the USB device into the USB socket.
- 3 Press the "SRC" button to select the USB mode to start playing.

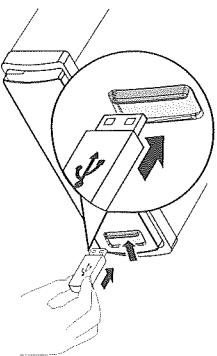

### 1A USB Universal Charge

- 1 Slide the USB socket to left.
- 2 Insert the Smart Phone device into the USB socket.
- 3 Once the Smart Phone is connected and recognized, the Smart Phone begins to charge.

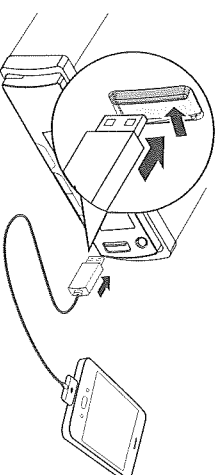

### Playing a SD memory card

- 1 Press the Panel (Release) button.
- 2 Push the left side of the panel rightward
- 3 Insert the card into the card slot.
- 4 Close the front panel.
- 5 Press the "SRC" button to select the SD mode to start playing.

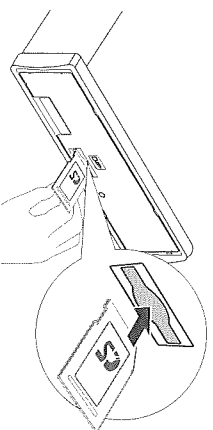

### Listening to the other external components

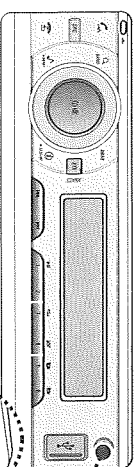

Auxiliary input jack

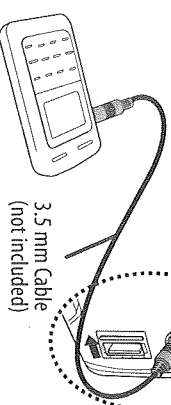

3.5 mm Cable (not included)

- 1 Press the **SRC** to select AUX-IN mode.
- 2 Turn on the external component and start playing.

## Operation of Bluetooth Hands-Free

- Press to answer / accept the call.
- Press and hold to transfer the call.

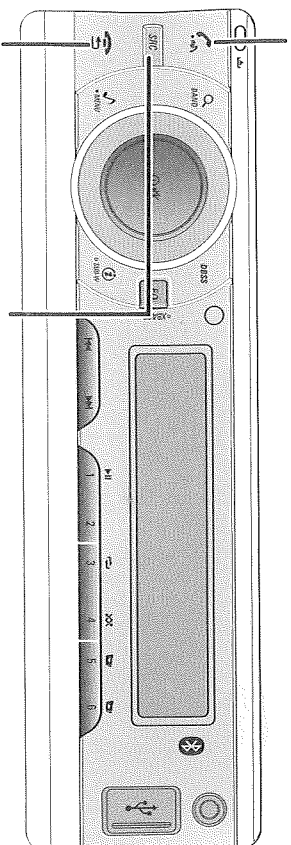

Press to reject / end the call. Press to change to "BT AUDIO" mode

You can make or receive phone calls with Bluetooth-enabled phones through the unit. You can also listen to music from a Bluetooth-enabled device.

### Getting Started

Before use the Bluetooth device, you need to pair the device to the unit. Pairing needs only to be done once.

#### Pairing the Bluetooth devices

- 1 Open your mobile phone and switch bluetooth on.
- 2 Search for other bluetooth device with your device.
- 3 Select "NAKAMICHI" in the pairing list.
- 4 Input the password "0000"
- 5 [Paired] will be displayed on the screen if pairing is successful, and the paired device will connect to the car audio system automatically.

#### Disconnect the bluetooth

- 1 Press and hold **MENU** to enter into the [MENU] mode.
- 2 Once the [DIS-CON] is displayed, press **OK** to activate the manual Disconnect mode.

#### Re-connect the bluetooth

- 1 Press and hold **MENU** to enter into the [MENU] mode.
- 2 Once the [RE-CON] is displayed, press **OK** to activate the manual Re-connect mode.

### Making a Call

You can dial number through the mobile phone.

- 1 Use the Mobile Phone to dial and make an outgoing call.
- 2 Once completed the dialing, [CALLING] is displayed.

#### To redial number

- 1 Press **CALL** on front panel to redial.
- 2 Press **OK**, unit will display [CALLING], and the unit starts dialing the number dialed last time.

#### Remark:

To make an outgoing call on this unit, the bluetooth connection between the unit and the phone must be active.

### Receiving a Call

- 1 If there is incoming call, the phone number is displayed. If the incoming call has no phone number, [PHONE IN] is displayed.
- 2 Press **CALL** to answer / accept the call.
- 3 When conversation ends, press **CALL** to terminate the call.

#### Call Transfer

You can transfer voice from loudspeaker to mobile phones during call.

During talking, press and hold **CALL** voice transfers from loudspeaker to mobile phone.

### Bluetooth Audio Streaming A2DP

If the connected Bluetooth device supports Advanced Audio Distribution Profile (A2DP), you can listen to the music stored on the device through the unit. If the device also supports Audio Video Remote Control Profile (AVRCP) profile, you can use the control on the unit or its remote control to play music stored on the device.

- 1 Press **SRC** repeatedly to select [BT AUDIO].
- 2 Press **PLAY** to start play, press it again to pause.
- 3 To track up/down, press **FF** / **REW**.

## Remote Control Operation

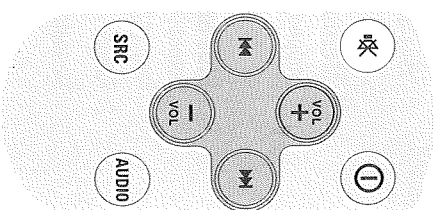

### When you press or hold the following button(s)...

Main unit	General operation
<b>CALL</b>	Turn mute or restore volume.
<b>CALL</b>	Press turn the unit on or off.
<b>VOL+</b>	Press increases the volume.
<b>VOL-</b>	Press decreases the volume.
<b>CALL</b>	<ul style="list-style-type: none"> <li>■ Under Radio mode to enter into the Auto Seek mode, press and hold to enter into the Manual Seek mode.</li> <li>■ Under Media playback mode to skip track / file, press and hold to fast forward / backward.</li> </ul>
<b>SRC</b>	Selects the available sources (Radio, USB (USB-iPod/iPhone), SD, BT AUDIO or Aux-In), if the power is turned on.
<b>AUDIO</b>	Press to access into the Audio Menu mode.

## Product Information

### General

Power Supply: 12V DC (10.5-14.4V), negative ground  
Fuse: 15A  
Suitable Speaker Impedance: 4-8Ω  
Aux-In level: 800mV

### USB devices

USB Flash Memory: USB 1.1 & 2.0 Compatible

### Memory Card

Support type of memory card: SD/SDHC

### Audio Section

Maximum Power Output: 50W x 4 Channels  
Continuous Power Output: 22W x 4 RMS  
Pre-AMP Output Voltage: 1.5V  
Subwoofer Output Voltage: 1.5V

### Bluetooth

Output power: Class 2  
Frequency band: 2.400GHz-2.4835GHz ISM Band  
Range: 3 meters (free space)  
Standard: Bluetooth 2.0 specification

### FM tuner section

Frequency Range: 87.5-107.9MHz (USA)  
87.5-108MHz (Europe)  
87.5-108MHz (Latin)  
87.5-108MHz (Middle East)  
87.5-108MHz (ASIA)  
76-90MHz (Japan)  
87.5-108MHz (Australia)  
87.5-108MHz (Oirt FM1 & FM2)  
65-74 MHz (Oirt FM3)

Usable Sensitivity: Better than 8dB at S/N 30dB

### About Audio file

- USB or memory file system: FAT16, FAT32
- MP3/WMA bit rate: 32-320kpbs and variable bit rate
- MP3 sampling frequencies: 8-48KHz
- WMA sampling frequencies: 32KHz, 44.1KHz, 48KHz
- ID3 tag v1.0 or later
- Supported WAV audio files

### AM tuner section

Frequency Range: 530-1710KHz (USA)  
522-1620KHz (Europe)  
530-1710KHz (Latin)  
522-1620KHz (Middle East)  
522-1620KHz (ASIA)  
522-1629KHz (Japan)  
522-1620KHz (Australia)  
522-1620KHz (Oirt)

### USB Smart Phone 1A charging

Output Voltage: 5V DC  
Output Current: 1000 mA (1A)

Usable Sensitivity: Better than 40dB at S/N 20dB