



# **NA400**

---

Car Audio System Player

## **INSTRUCTION MANUAL**

**DVD CD MP3 WMA**

**USB AUX-IN**

## Safety

### WARNING

Stop the car before operating the unit.

### Important to know...

- ★ To prevent a short circuit, never put or leave any metallic objects (such as coins or metal tools) inside the unit.
- ★ **Caution:** Adjust the volume so that you can hear sounds outside the car. Driving with the volume too high may cause an accident.
- ★ **Condensation:** When the car is air-conditioned, moisture may collect on the laser lens. This may cause disc read errors. In this case, remove the disc and wait for the moisture to evaporate.
- ★ The illustrations in this manual are examples used to explain more clearly how the controls are used. Therefore, what appears on the illustrations may differ from what appears on the actual equipment.
- ★ If you experience problems during installation, consult your Nakamichi dealer.
- ★ When you purchase external components, check with your Nakamichi dealer to make sure that they work with your model and in your area.

### Maintenance

Cleaning the unit: Wipe off the dirt on the panel with a dry silicon or soft cloth. Failure to observe this precaution may result in damage to the monitor or unit.

Cleaning the connector: Wipe off dirt on the connector of the unit and faceplate. Use a cotton swab or cloth.

**Caution:** THIS MOBILE DVD PLAYER IS A CLASS I LASER PRODUCT. THIS UNIT USES A VISIBLE / INVISIBLE LASER BEAM WHICH COULD CAUSE HAZARDOUS RADIATION IF EXPOSED DIRECTLY. BE SURE TO OPERATE THE MOBILE DVD PLAYER CORRECTLY AS INSTRUCTED. USE OF CONTROLS OR ADJUSTMENTS OR PERFORMANCE OR PROCEDURES OTHER THAN THOSE SPECIFIED HEREIN MAY RESULT IN HAZARDOUS RADIATION EXPOSURE. DO NOT OPEN COVERS AND DO NOT REPAIR BY YOURSELF PLEASE REFER SERVICING TO A QUALIFIED TECHNICIAN.

## Preparation

### How to attach/detach the faceplate

#### Attach

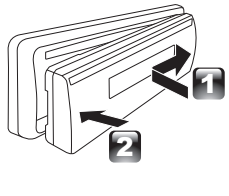

#### Detach

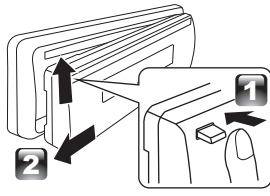

- ★ Do not expose the faceplate to direct sunlight, excessive heat, or humidity. Also avoid places with too much dust or the possibility of water splashing.
- ★ Keep the faceplate in its casing while detached.
- ★ The faceplate is a precision piece of equipment and can be damaged by shocks or jolts.
- ★ To prevent deterioration, do not touch the terminals of the unit and faceplate with your fingers.

### How to reset your unit

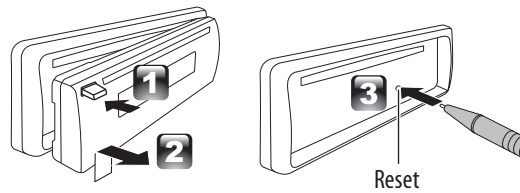

- ★ If this unit fails to operate properly, press the reset button.
- ★ The unit returns to factory settings when the reset button is pressed.

## What's in the box

Check and identify the contents of your package:

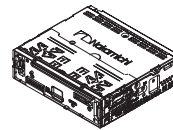

Main unit  
(with sleeve)

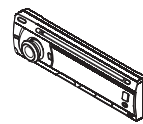

Front panel

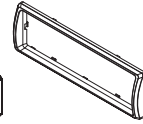

Trim plate



Carrying case  
(for front panel)

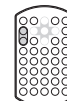

Remote control

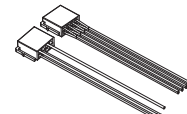

ISO male connector

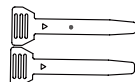

Disassembly tool  
(2pcs)



Screw x 4pcs









User manual

## Disc and Format Supports

This unit can play various video/audio format which stored into Disc / USB on Media Player.

The following chart helps you to check if a Disc is supported by this unit, as well as what functions are available for a given Disc type.

	Digital Versatile Discs (DVDs)
	Video CDs (VCDs)
	Digital Versatile Discs Recordable (DVD+/-R)
	Digital Versatile Discs Rewritable (DVD+/-RW)
	Compact Discs (CDs)
	CD Recordable (CD-R)
	CD Rewritable (CD-RW)

### Audio Format

Playback CD-DA and MP3 or WMA digital music file on CD-ROM or DVD-ROM or USB.

#### Note of MP3 and WMA

- Support Maximum 2000 files
- Supported Sampling frequencies; 32kHz, 44.1kHz, 48kHz.
- Supported Bit-Rates: 64-256kbps variable bit rate
- ID3 tag version 1.0 and 1.1.

### Video Format

Playback IMAGE JPEG, DVD Video, MPEG4. On CD-ROM or DVD-ROM or USB.

#### Note of MPEG4

Supported decoding MPEG-4 video defined by ISO 14496-2 Standard:

1. Simple Profile (SP)
2. Advance Simple Profile (ASP) Supported file format: MP4 and M4a (audio only)

### Unsupported Discs

8cm Disc, CDV, CDI, CDG, LD, DVD RAM

### Note on Region code



DVD players and DVD Video discs have their own Region Code numbers. This unit can play the disc of all region code numbers.

### Disc Maintenance

Before playing, wipe the disc using a clean cloth, working from the center hole towards the outside edge. Never use benzene, thinners, cleaning fluids or anti-static liquids or any other solvent.



#### Remark:

A disc may become somewhat scratched (although not enough to make it unusable) depending on you handle it and conditions in the usage environment.

Note these scratches are not an indication of any problem with the player.

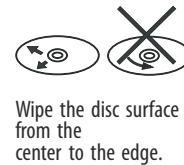
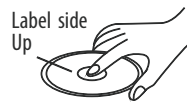

## Installation / Connection

### Basic Procedure

- 1 Remove the key from the ignition switch, then disconnect the  $\ominus$  terminal of the car battery.
- 2 Make proper input and output wire connections.
- 3 Install the unit to your car.
- 4 Reconnect the  $\ominus$  terminal of the car battery.
- 5 Reset the unit.

### Warning

- ★ The unit can only be installed in a car with a 12V DC power supply, negative ground.
- ★ If you connect the ignition wire (red) and the battery wire (yellow) to the car chassis (ground), you may cause a short circuit, that in turn may start a fire. Always connect those wires to the power source running through the fuse box.
- ★ Disconnect the battery's negative terminal and make all electrical connections before installing the unit.
- ★ Insulate unconnected wires with vinyl tape or other similar material. To prevent a short circuit, do not remove the caps on the ends of the unconnected wires or the terminals.
- ★ Be sure to ground this unit to the car's chassis again after installation.
- ★ If the power is not turned ON, the speaker wire may have a short-circuit or touched the chassis of the vehicle and the protection function may have been activated. Therefore, the speaker wire should be checked.

### Caution

- ★ If your car's ignition does not have an ACC position, connect the ignition wires to a power source that can be turned on and off with the ignition key. If you connect the ignition wire to a power source with a constant voltage supply, as with battery wires, the battery may die.
- ★ Install this unit in the console of your vehicle. Make sure the faceplate will not hit the lid of the console (if any) when closing and opening.
- ★ After the unit is installed, check whether the brake lamps, blinkers, wipers, etc. on the car are working properly.
- ★ Mount the unit so that the mounting angle is 30° or less.
- ★ If the fuse blows, first make sure the wires are not touching to cause a short circuit, then replace the old fuse with one that has the same rating.
- ★ Connect the speaker wires correctly to the terminals to which they correspond. The unit may be damaged or fail to work if you share the  $\ominus$  wires or ground them to any metal part in the car.
- ★ When only two speakers are being connected to the system, connect the connectors either to both the front output terminals or to both the rear output terminals (do not mix front and rear).
- ★ Mounting and wiring this product requires skills and experience. For safety's sake, leave this work to professionals. If you experience problems during installation, consult your Nakamichi dealer.

### Wiring Connection

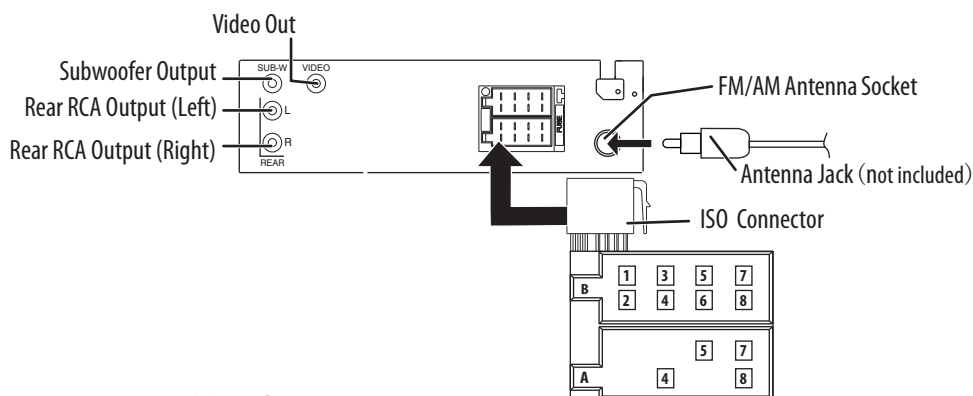

### ISO Connector Wiring Chart

Pin	Color and function	Pin	Color and function
A4	Yellow Battery(+)	B1/B2	Violet $\oplus$ / Violet/Black $\ominus$ Right rear speaker
A5	Blue Connect to system control terminal of the power AMP or auto antenna relay control terminal (Max 150MA 12VDC)	B3/B4	Grey $\oplus$ / Grey/Black $\ominus$ Right front speaker
A7	Red Ignition(ACC)	B5/B6	White $\oplus$ / White/Black $\ominus$ Left front speaker
A8	Black Ground	B7/B8	Green $\oplus$ / Green/Black $\ominus$ Left rear speaker

## Installing the unit

1

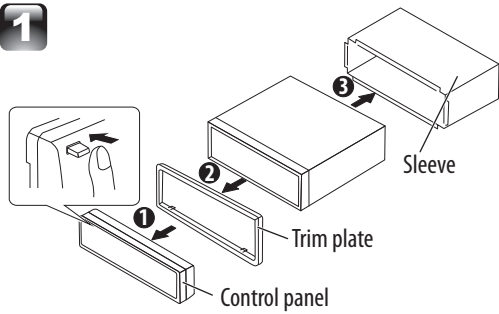

2

Before attaching, make sure the direction of the escutcheon is correct. (Wider hooks on the bottom side.)

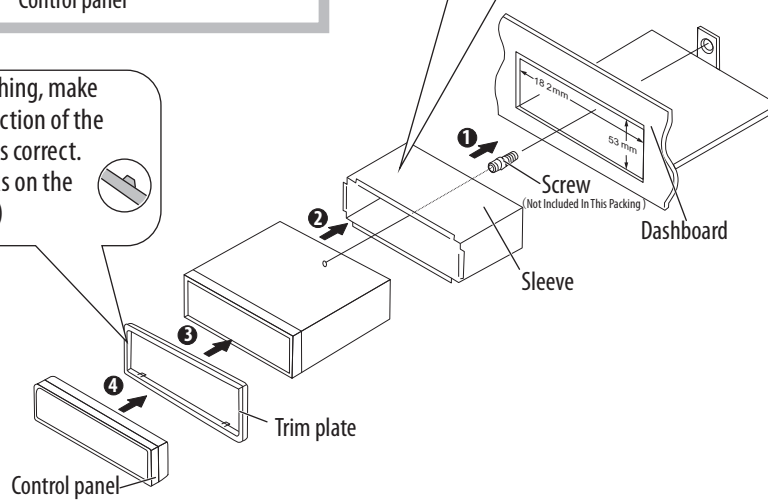

## Removing the unit

- 1 Detach the control panel.
- 2 Engage the catch pin on the removal tools into the holes on both sides of the escutcheon, then pull it out.
- 3 Insert the disassembly tools deeply into the slots on each side, then follow the arrows instructions as shown on the right.

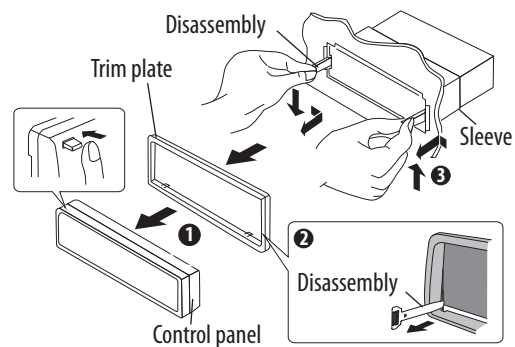

## Basic Operation

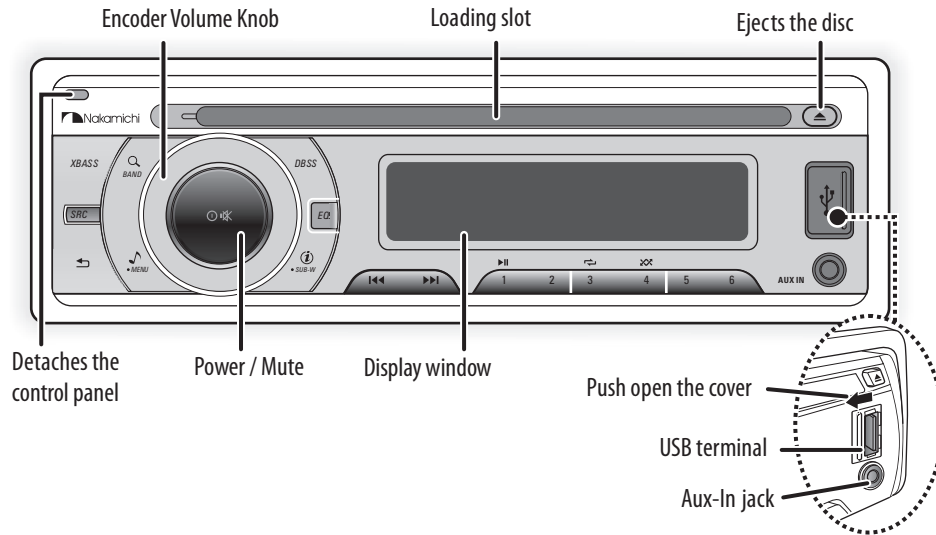

### When you press or hold the following button(s)...

Main unit	General operation
<b>SRC</b>	Select the available sources, if the power is turned on.
Encoder Volume knob	Rotate it to increase or decrease the volume. Select items.
Power / Mute	<ul style="list-style-type: none"> <li>Turn mute or restore volume.</li> <li>Turn the unit on. Press and hold again to turn the unit off.</li> <li>Confirms selection.</li> </ul>
<b>BAND</b>	<ul style="list-style-type: none"> <li>Select the FM bands (FM1/ FM2/ FM3) or AM1 (MW1) / AM2 (MW2) .</li> <li>Under media playback to access into search mode.</li> </ul>
<b>1   </b>	Pause/resume playback of a Disc, USB .
<b>   &gt;&gt;&gt; / &lt;&lt;&lt;   </b>	<ul style="list-style-type: none"> <li>Under Radio mode to enter into the Auto Seek mode, press and hold to enter into the Manual Seek mode.</li> <li>Under Media playback mode to skip track / file, press and hold to fast forward / backward.</li> </ul>
<b>MENU</b>	To access into the Audio Menu mode, press and hold to enter into the System Menu mode.
<b>DBSS</b>	Press to turn On or Off dynamic bass boost sound.
<b>SUB-W</b>	<ul style="list-style-type: none"> <li>To view the Clock, press and hold turn On or Off the subwoofer function.</li> <li>Under Media playback mode to view play informations.</li> </ul>
<b>EQ</b>	To adjust the EQ (Preset Equalizer) setting.
<b>XBASS</b>	Turn On or Off the Xbass booster function.
<b>↶</b>	Return to the previous item.

## Function Settings

- 1 Press **MENU** to access into the **[AUDIO MENU]** mode, press and hold to enter into the **[MENU]** mode.
- 2 Press **◀/▶** repeatedly to select the item to be adjusted.
- 3 Turn the encoder volume knob to select a value/ option.

### [AUDIO MENU]...

Item	Selectable Setting
BASS ADJUST	
BASS LEVEL	Adjust the level -7 to +7.
BASS CFQ	Select the center frequency: 60 / 80 / 100 / 200
MIDDLE ADJUST	
MIDDLE LEVEL	Adjust the level -7 to +7.
MIDDLE CFQ	Select the center frequency: 0.5K / 1.0K / 1.5K / 2.5K
TREBLE ADJUST	
TREBLE LEVEL	Adjust the level -7 to +7.
TREBLE CFQ	Select the center frequency: 10.0K / 12.5K / 15.0K / 17.5K
BALANCE	Adjust the balance between the right and left speakers from 12R (full right) to 12L (full left).
FADER	Adjust the fader between the front and rear speakers from 12L (full rear) to 12L (full front).
SUBWOOFER ADJUST	
SUBWOOFER	Adjust the level 0 to 50.
SUBWOOFER LPF	Subwoofer low pass filter range: 80 / 120 / 160
RESUME	Resume the preset EQ value to factory default value.

### [MENU]...

Item	Selectable Setting
CLOCK	
CLOCK SET	Adjust the Hours and Minutes
CLOCK FORMAT	Select the time format 12H or 24H
BEEP TONE	Turn On or Off this beep sound
DIMMER	Adjust the LCD display backlight level between Hight or Low

## Listening to the Radio

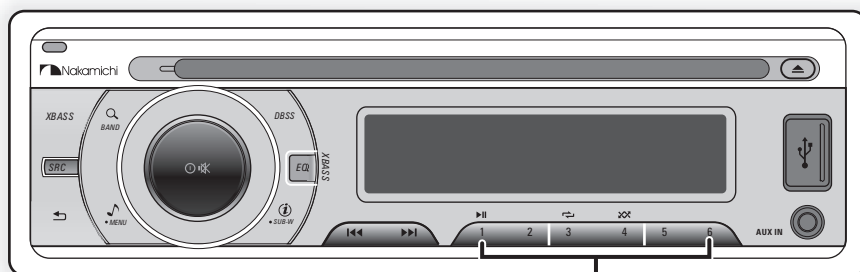

- Hold for about 2 seconds to memorize the current station .
- Press briefly to recall memorized station.

- 1 Press **BAND** repeatedly to a band ( FM1, FM2, FM3, AM1(MW1) or AM2(MW2) ).
- 2 Press **SEEK** to search for a station.

### Adjust [MENU] mode settings

While listening to the radio...

- 1 Press and hold **MENU** to enter into the [MENU] mode.
- 2 Press **SEEK** repeatedly to select the item to be adjusted.
- 3 Turn the encoder volume knob to select a value / option.

Item	Selectable Setting
AUTO STORE	Press the <b>Auto Store</b> to access into Auto Store mode, the six strongest stations of the selected band are saved in preset channel automatically: FM1, FM2, FM3(1-6), AM1, AM2.
AREA	Select suitable country region of the radio: USA; LATIN; EUROPE; RUSSIA(0irt);
LOCAL SEEK	To receive more radio stations or only stations with strong signal, you can adjust the radio sensitivity.



## Play media files

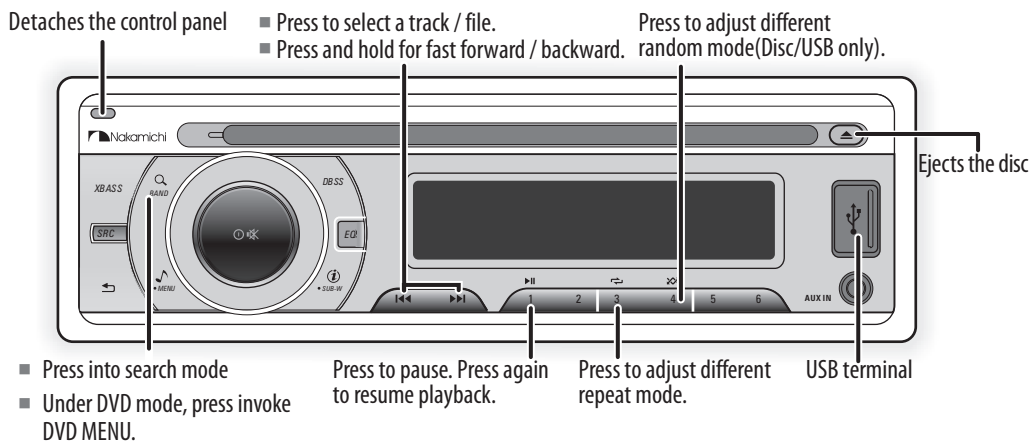

This unit can play various video / audio stored into Disc / USB or on media player.

You can play commercially available audio CDs and these Discs:

- Digital Versatile Discs (DVDs)
- Video Cds (VCDs)
- Digital Versatile Discs Recordable (DVD+/-R)
- Digital Versatile Discs Rewritable (DVD+/-RW)
- Compact Discs (Cds)
- CD Recordable (CD-R)
- CD Rewritable (CD-RW)

### Listening to a Disc/ USB device

#### Playing a disc

Insert the disc into the Disc Slot with label side facing up, the unit will play starts automatically.

#### Playing a USB device

- 1 Slide the USB socket cover market  to the left.
- 2 Insert the USB device into the USB socket. The unit starts playing from the USB device automatically.

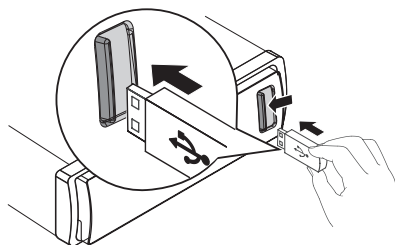

### DVD Operation

Once a DVD disc is inserted into the unit, the unit will automatically start the playback from the beginning of the disc, and then the DVD MENU or ROOT or TITLE in the DVD disc will appear on the external TFT monitor ( NOT INCLUDED IN THIS PRODUCT ) and "ROOT" will be displayed on the DISPLAY of the unit.

#### Remark:

Once the DVD MENU or ROOT or TITLE is displayed on the external TFT Monitor, user can rotate the Encoder Volume Knob to navigate thru the file list and press the Audio button to open the folder or to start the playback.

## Listening to the other external components

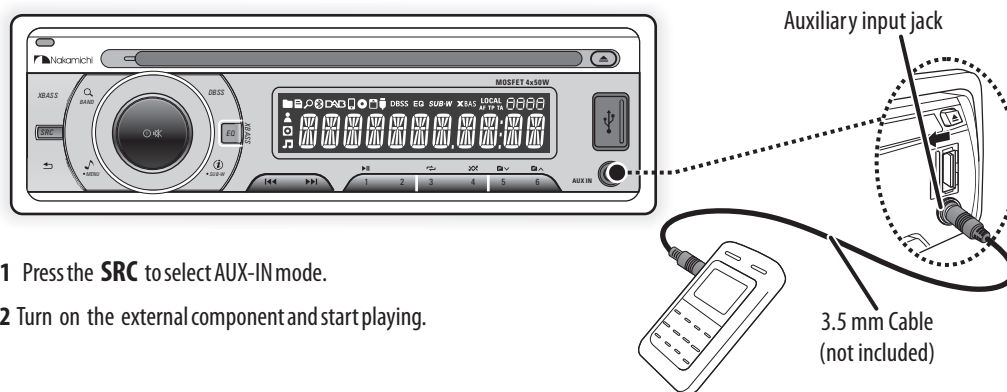

- 1 Press the **SRC** to select AUX-IN mode.
- 2 Turn on the external component and start playing.

## Remote Control Operation



### When you press or hold the following button(s)...

Item	General operation
	Press turn the unit on or off.
	Turn mute or restore volume.
	Press increases / decreases the volume.
	<ul style="list-style-type: none"> <li>Under Radio mode to enter into the Manual Seek mode.</li> <li>Under the media playback mode, press to fast forward / backward through the music under media player mode.</li> </ul>
	Use these buttons to move cursor up/down/left/right.
<b>ok</b>	Press to confirm the selection. <ul style="list-style-type: none"> <li>Under Radio mode to enter into the Auto Seek mode.</li> </ul>
	<ul style="list-style-type: none"> <li>Under Media playback mode to skip backward of the previous chapter / forward of the next chapter.</li> </ul>
<b>SOURCE</b>	Select the available sources, if the power is turned on.
<b>BAND</b>	Select the FM bands (FM1/ FM2/ FM3) or Am1 (MW1) / AM2 (MW2) .
<b>EQ</b>	To adjust the EQ (Preset Equalizer) setting.
<b>XBASS</b>	Turn On or Off the Xbass booster function.
<b>DBSS</b>	Press to turn On or Off dynamic bass boost sound.
	Return to the previous item.
	Press to Pause / Resume Play the music under media playback mode.
<b>1</b> <b>0</b>	Under media playback mode use these numeric for track or file number direct access and use when function need numeric selection or input.
<b>GOTO</b>	<ul style="list-style-type: none"> <li>Under the MP3/WMA mode, press to direct playback time.</li> <li>Under the DVD mode, press this button to direct Title/Chapter/ Time selection.</li> </ul>
<b>DVD SETUP</b>	Press enter into the setup mode.
	Press to view the clock.
<b>DISP</b>	Press to turn on the information on the TFT may vary according to this disc or files type.
<b>DVD AUDIO</b>	Under DVD playback mode, press to select audio language or audio channel.
<b>DVD MENU</b>	Under DVD mode, press to access into DVD main menu.
<b>SUB TITLE</b>	Under DVD mode, press during playback to turn on or off subtitles and change the subtitles.
<b>TITLE</b>	Under DVD mode to bring up the Title Menu.
<b>ZOOM</b>	When playback the DVD, press repeatedly to increase the magnification level.
<b>ANGLE</b>	Under DVD mode, press while playing a scene recorded with multiple angles to change the angle.

## Product Information

---

### General

Power Supply: 12V DC (10.5-14.4V), negative ground

Fuse: 15A

Suitable Speaker Impedance: 4 -8Ω

Aux-In level: 500mV

### Disc player

System: DVD/CD audio /MP3 system

Frequency Response: 20Hz to 20KHz +/-3dB

Signal to Noise Ratio: ≥90dB

Channel Separation: 2 Channel(Stereo)>60dB@1KHz

Video signal format: NTSC/PAL

Video Output: 1+/- 0.2V

### Audio Section

Maximum Power Output: Mosfet 50W x 4 Channels

Continuous Power Output: 24W x 4 RMS

Pre-AMP Output Voltage: 3V

Subwoofer Output Voltage: 3V

### FM tuner section

Frequency Range: 87.5 - 108MHz

Usable Sensitivity: Better than 15dB at S/N 30dB

### AM tuner section

Frequency Range: 522 - 1620KHz

Usable Sensitivity: Better than 45dB at S/N 26dB

### USB devices

USB Flash Memory: USB 1.1 & 2.0 Compatible



 Nakamichi®

