



NA250BTR

Car Audio System Player

INSTRUCTION MANUAL

CD MP3 WMA USB SD

AUX-IN BT

Safety

WARNING

Stop the car before operating the unit.

Important to know...

- ★ To prevent a short circuit, never put or leave any metallic objects (such as coins or metal tools) inside the unit.
- ★ **Caution:** Adjust the volume so that you can hear sounds outside the car. Driving with the volume too high may cause an accident.
- ★ **Condensation:** When the car is air-conditioned, moisture may collect on the laser lens. This may cause disc read errors. In this case, remove the disc and wait for the moisture to evaporate.
- ★ The illustrations in this manual are examples used to explain more clearly how the controls are used. Therefore, what appears on the illustrations may differ from what appears on the actual equipment.
- ★ If you experience problems during installation, consult your Nakamichi dealer.
- ★ When you purchase external components, check with your Nakamichi dealer to make sure that they work with your model and in your area.

Maintenance

Cleaning the unit: Wipe off the dirt on the panel with a dry silicon or soft cloth. Failure to observe this precaution may result in damage to the monitor or unit.

Cleaning the connector: Wipe off dirt on the connector of the unit and faceplate. Use a cotton swab or cloth.

Preparation

How to attach/detach the faceplate

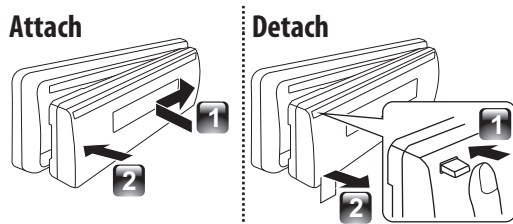

- ★ Do not expose the faceplate to direct sunlight, excessive heat, or humidity. Also avoid places with too much dust or the possibility of water splashing.
- ★ Keep the faceplate in its casing while detached.
- ★ The faceplate is a precision piece of equipment and can be damaged by shocks or jolts.

- ★ To prevent deterioration, do not touch the terminals of the unit and faceplate with your fingers.

How to reset your unit

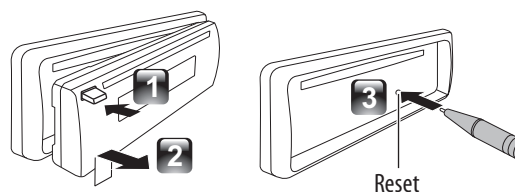

- ★ If this unit fails to operate properly, press the reset button.
- ★ The unit return to factory setting when the reset button is pressed.

What's in the box

Check and identify the contents of your package:

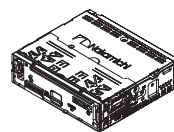

Main unit
(with sleeve)

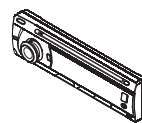

Front panel

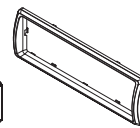

Trim plate



Carrying case
(for front panel)



Remote
control

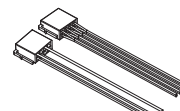

ISO male
connector

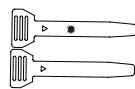

Disassembly tool
(2pcs)



Screw x 4pcs

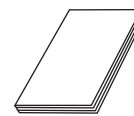

User manual

Highlight Features

This unit is allowed to connect the 5V preout for Subwoofer.



Variable Color illumination This unit is equipped with variable color display/illumination.

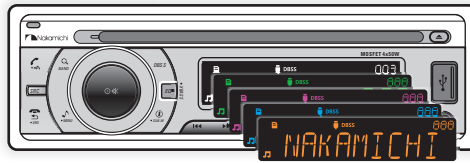

This unit is allowed to connect the 5V preout for Rear and Front RCA Line Out.

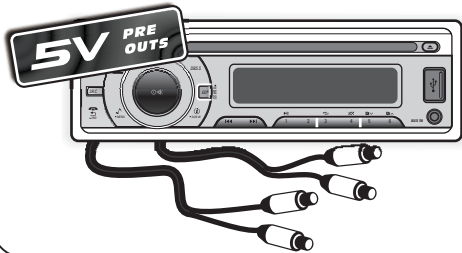

Under Disc/USB/SD/iPod/iPhone playback mode, press **⏮/⏭** buttons first, and then press and hold **⏮/⏭** buttons within one second, it can be access into quick music file access track or file up/down browse feature.

Installation / Connection

Basic Procedure

- 1 Remove the key from the ignition switch, then disconnect the \ominus terminal of the car battery.
- 2 Make proper input and output wire connections.
- 3 Install the unit to your car.
- 4 Reconnect the \ominus terminal of the car battery.
- 5 Reset the unit.

Warning

- ★ The unit can only be installed in a car with a 12V DC power supply, negative ground.
- ★ If you connect the ignition wire (red) and the battery wire (yellow) to the car chassis (ground), you may cause a short circuit, that in turn may start a fire. Always connect those wires to the power source running through the fuse box.
- ★ Disconnect the battery's negative terminal and make all electrical connections before installing the unit.
- ★ Insulate unconnected wires with vinyl tape or other similar material. To prevent a short circuit, do not remove the caps on the ends of the unconnected wires or the terminals.
- ★ Be sure to ground this unit to the car's chassis again after installation.
- ★ If the power is not turned ON, the speaker wire may have a short-circuit or touched the chassis of the vehicle and the protection function may have been activated. Therefore, the speaker wire should be checked.

Caution

- ★ If your car's ignition does not have an ACC position, connect the ignition wires to a power source that can be turned on and off with the ignition key. If you connect the ignition wire to a power source with a constant voltage supply, as with battery wires, the battery may die.
- ★ Install this unit in the console of your vehicle. Make sure the faceplate will not hit the lid of the console (if any) when closing and opening.
- ★ After the unit is installed, check whether the brake lamps, blinkers, wipers, etc. on the car are working properly.
- ★ Mount the unit so that the mounting angle is 30° or less.
- ★ If the fuse blows, first make sure the wires are not touching to cause a short circuit, then replace the old fuse with one that has the same rating.
- ★ Connect the speaker wires correctly to the terminals to which they correspond. The unit may be damaged or fail to work if you share the \ominus wires or ground them to any metal part in the car.
- ★ When only two speakers are being connected to the system, connect the connectors either to both the front output terminals or to both the rear output terminals (do not mix front and rear).
- ★ Mounting and wiring this product requires skills and experience. For safety's sake, leave this work to professionals. If you experience problems during installation, consult your Nakamichi dealer.

Wiring Connection

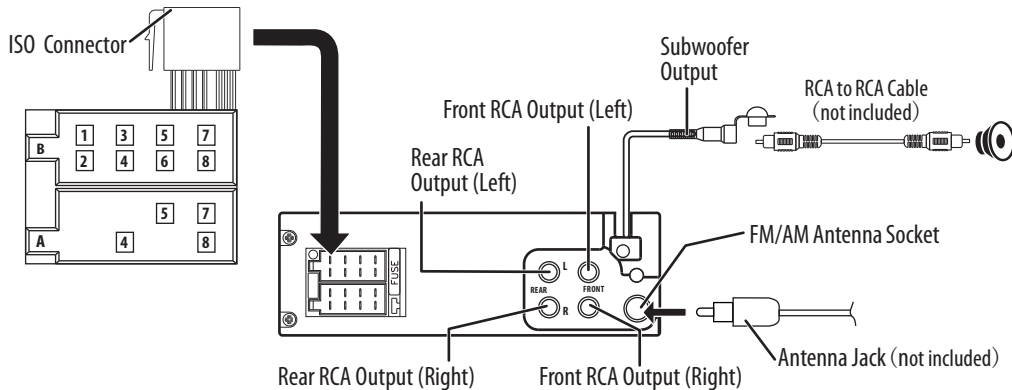

ISO Connector Wiring Chart

Pin	Color and function	Pin	Color and function
A4	Yellow Battery(+)	B1/B2	Violet \oplus / Violet/Black \ominus Right rear speaker
A5	Blue Connect to system control terminal of the power AMP or auto antenna relay control terminal(Max 150MA 12VDC)	B3/B4	Grey \oplus / Grey/Black \ominus Right front speaker
A7	Red Ignition(ACC)	B5/B6	White \oplus / White/Black \ominus Left front speaker
A8	Black Ground	B7/B8	Green \oplus / Green/Black \ominus Left rear speaker

Installing the unit

1

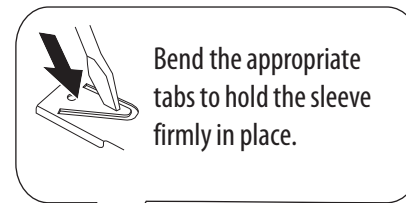
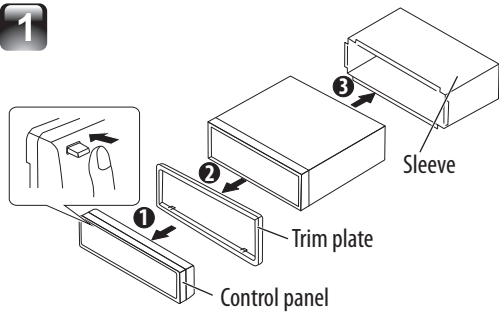

2

Before attaching, make sure the direction of the escutcheon is correct. (Wider hooks on the bottom side.)

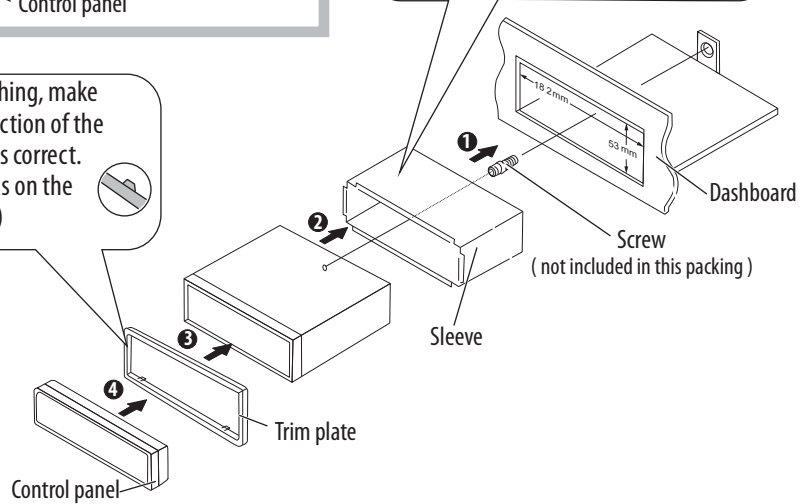

Removing the unit

- 1 Detach the control panel.
- 2 Engage the catch pin on the removal tools into the holes on both sides of the escutcheon, then pull it out.
- 3 Insert the disassembly tools deeply into the slots on each side, then follow the arrows instructions as shown on the right.

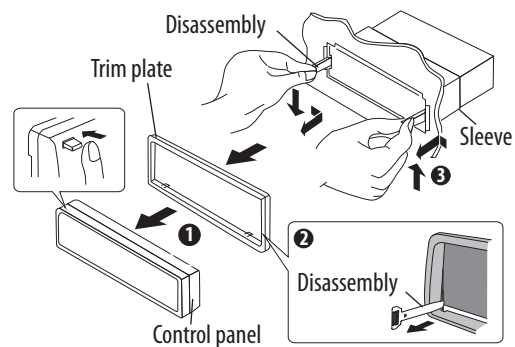

Basic Operation

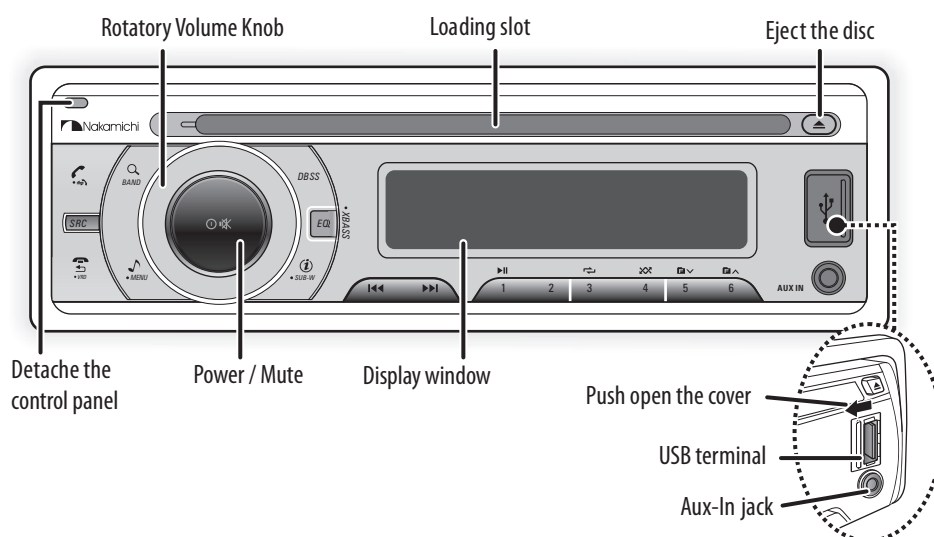

When you press or hold the following button(s)...

Main unit	General operation
SRC	Select the available sources (Radio, Disc, USB, SD, BT AUDIO or Aux-In), if the power is turned on.
Rotatory Volume knob	Rotate it to increase or decrease the volume. Select items.
Power / Mute	<ul style="list-style-type: none"> Turn mute or restore volume. Turn the unit on. Press and hold again to turn the unit off. Confirms selection.
BAND	<ul style="list-style-type: none"> Select the FM bands (FM1/ FM2/ FM3) or AM1 (MW1) / AM2 (Mw2). Under media playback to access into search mode. Press and hold to activate the Auto Store function.
1	Pause/resumes playback of a Disc, USB / SD device.
	<ul style="list-style-type: none"> Under Radio mode to enter into the Auto Seek mode, press and hold to enter into the Manual Seek mode. Under Media playback mode to skip track / file, press and hold to fast forward / backward.
MENU	To access into the Audio Menu mode, press and hold to enter into the System Menu mode.
DBSS	Press and hold to turn On or Off dynamic bass boost sound.
SUB-W	<ul style="list-style-type: none"> To view the Clock, press and hold turn On or Off the subwoofer function. Under RDS mode to view RDS received information. Under Media playback mode to view play informations.
EQ / XBASS	<ul style="list-style-type: none"> To adjust the EQ (Preset Equalizer) setting. Turn On or Off the Xbass booster function.
	<ul style="list-style-type: none"> To answer / accept the call. During the talking, press and hold to transfer the call.
VRD	<ul style="list-style-type: none"> To reject / end the call. Returns to the previous item. Press and hold access into the VRD display color setting mode.

Function Setting

- 1 Press **MENU** to access into the **[AUDIO MENU]** mode, press and hold to enter into the **[MENU]** mode.
- 2 Press **◀/▶** repeatedly to select the item to be adjusted.
- 3 Turn the encoder volume knob to select a value / option.

[AUDIO MENU] ...

Item	Selectable Setting
BASS ADJUST	
BASS LEVEL	Adjust the level -7 to +7.
BASS CFQ	Select the center frequency: 60 / 80 / 100 / 200
MIDDLE ADJUST	
MIDDLE LEVEL	Adjust the level -7 to +7.
MIDDLE CFQ	Select the center frequency: 0.5K / 1.0K / 1.5K / 2.5K
TREBLE ADJUST	
TREBLE LEVEL	Adjust the level -7 to +7.
TREBLE CFQ	Select the center frequency: 10.0K / 12.5K / 15.0K / 17.5K
BALANCE	Adjust the balance between the right and left speakers from 12R (full right) to 12L (full left).
FADER	Adjust the fader between the front and rear speakers from 12R (full rear) to 12L (full front).
SUBWOOFER ADJUST	
SUBWOOFER	Adjust the level 0 to 12.
SUBWOOFER LPF	Subwoofer low pass filter range: 80 / 120 / 160
RESUME	Resume the preset EQ value to factory default value.

[MENU] ...

Item	Selectable Setting
CLOCK	
CLOCK SET	Adjust the Hours and Minutes
CLOCK FORMAT	Select the time format 12H or 24H
BEEP TONE	Turn On or Off this beep sound
DIMMER	Adjust the LCD display backlight level between Hight or Low
VRD DISPLAY COLOR	This unit is equipped with variable color display. Once into the DISPLAY COLOR mode, rotating encoder volume knob to selected the LCD color. <ul style="list-style-type: none"> ■ COLOR SCAN (default setting); WHITE; GREEN 1; GREEN 2; GREEN 3; AMBER; PINK 1; PINK 2; PURPLE 1; PURPLE 2; BLUE 1; BLUE 2; USER COLOR; ORANGE
DEMO	To automatically demo this unit's major features cyclic on LCD display.

Listening to the Radio

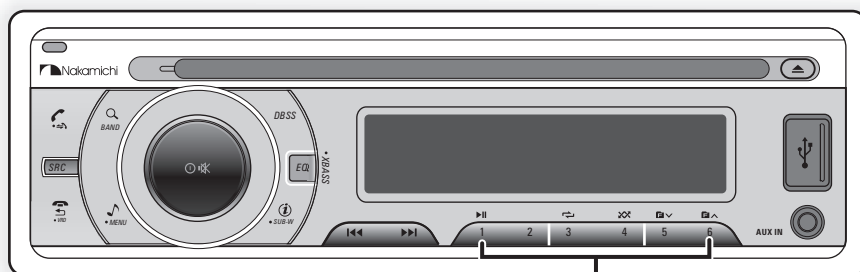

- Hold for about 2 seconds to memorize the current station .
- Press briefly to recall memorized station.

- 1 Press **BAND** repeatedly to a band (FM1, FM2, FM3, AM1(MW1) or AM2(MW2) .
- 2 Press **SEARCH** to search for a station.
- 3 Press **SUB-W** repeatedly to view RDS received information.

Adjust [MENU] mode setting

While listening to the radio...

- 1 Press and hold **MENU** to enter into the [MENU] mode.
- 2 Press **SEARCH** repeatedly to select the item to be adjusted.
- 3 Turn the encoder volume knob to select a value / option.

Item	Selectable Setting
AUTO STORE	Press the to access into Auto Store mode, the six strongest stations of the selected band are saved in preset channel automatically: FM1, FM2, FM3(1-6), AM1, AM2.
PTY (Program Type)	Once into the PTY mode, press the get into program type item, and rotating encoder volume knob to selected category. <ul style="list-style-type: none"> ■ Available Program Type: POP M; ROCK M; EASY M; LIGHT M; CLASSICS; OTHER M; JAZZ M; COUNTRY; NATION M; OLDIES M; FOLK M; A-TEST; ALARM; NEWS; AFFAIRS; INFO; SPORT; EDUCATE; DRAMA; CULTURE; SCIENCE; VARIED; WEATHER; FINANCE; CHILDREN; SOCIAL; RELIGION; PHONE IN; TRAVEL; LEISURE; DOCUMENT
AF (Alternate Frequencies)	<ul style="list-style-type: none"> ■ ON: The unit will be searches for another station with stronger signal, but with the same program identification as the current station automatically. ■ OFF: Cancel
TA (Traffic Announcement)	<ul style="list-style-type: none"> ■ ON: When there is traffic announcement, the unit switches to the tuner mode (regardless of the current mode) and begins to broadcast the announcemet on traffic conditions. When the trafficanouncement is over, it returns to the previous mode. ■ OFF: Traffic announcement does not cut in.
RDS On/Off	Turn On or Off the RDS function.
AREA	Select suitable country region of the radio: USA; LATIN; EUROPE; RUSSIA(Oirt); M-EAST; ASIA; JAPAN; AUST (Australia)
LOCAL SEEK	To receive more radio stations or only stations with strong signal, you can adjust the radio sensitivity.

Listening to a Disc/ USB/SD device

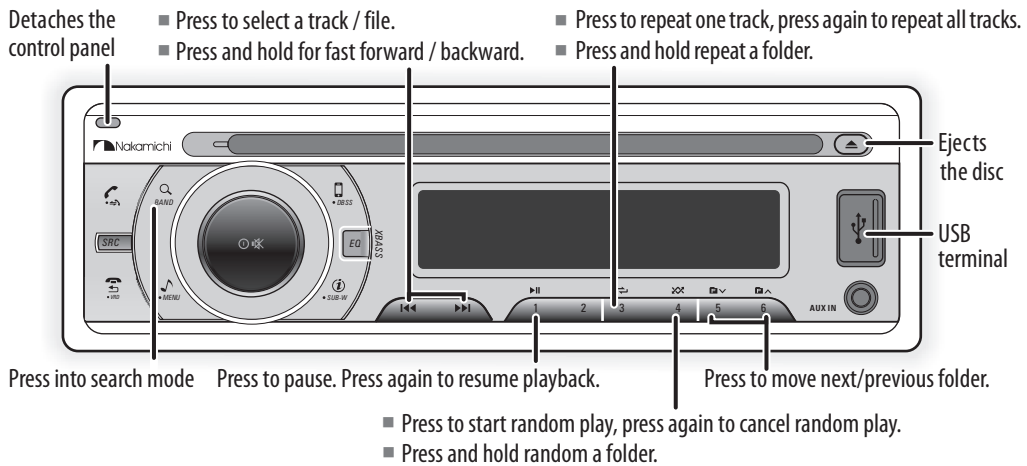

Playing a disc

Insert the disc into the Disc Slot with label side facing up, the unit will play starts automatically.

Playing a USB device

- Slide the USB socket cover market  to the left.
- Insert the USB device into the USB socket. The unit starts playing from the USB device automatically.

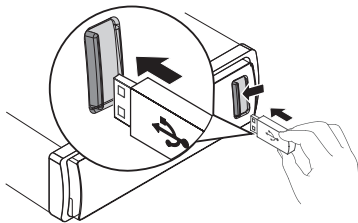

Playing a SD memory card

- Press the Panel  (Release) button.
- Push the left side of the panel rightward
- Insert the card into the card slot.
- Close the front panel, then the unit starts playing from the card automatically.

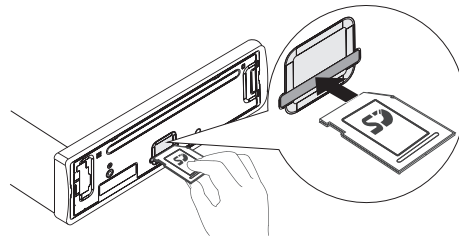

Listening to the other external components

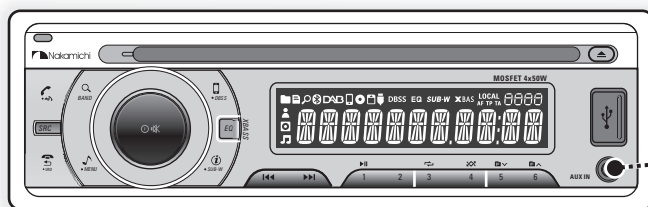

- Press the **SRC** to select AUX-IN mode.
- Turn on the external component and start playing.

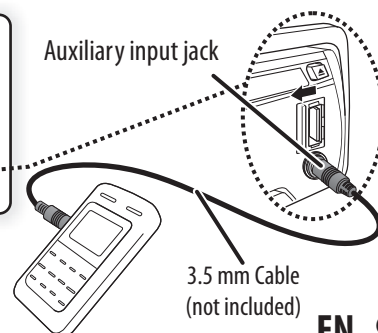

Operation of Bluetooth Hands-Free

- Press to answer / accept the call.
- Press and hold to transfer the call.

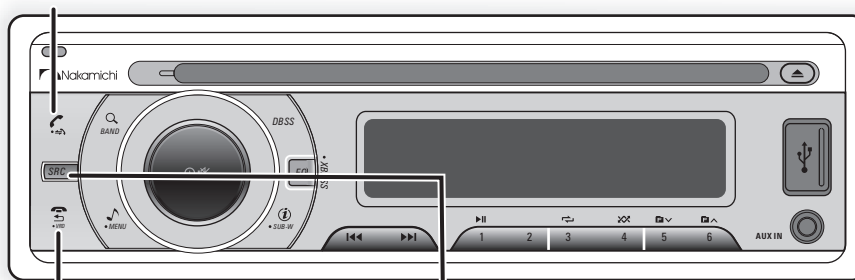

Press to reject / end the call.

Press to change to "BT AUDIO" mode

You can make or receive phone calls with Bluetooth-enabled phones through the unit. You can also listen to music from a Bluetooth-enabled device.

Getting Started

Before use the Bluetooth device, you need to pair the device to the unit. Pairing needs only to be done once.

Pairing the Bluetooth devices

- 1 Open your mobile phone and switch bluetooth on.
- 2 Search for other bluetooth device with your device.
- 3 Select "NAKAMICHI" in the pairing list.
- 4 Input the password "0000"
- 5 [Pairing OK] will be displayed on the panel if pairing is successful, and the paired device will connect to the car audio system automatically.

Disconnect the bluetooth

- 1 Press and hold **MENU** to enter into the [MENU] mode.
- 2 Once the [BT DISCONN] is displayed, press **CALL** to activate the manual Disconnect mode.

Re-connect the bluetooth

- 1 Press and hold **MENU** to enter into the [MENU] mode.
- 2 Once the [BT CONNECT] is displayed, press **CALL** to activate the manual Re-connect mode.

Making a Call

You can dial number through the mobile phone.

- 1 Use the Mobile Phone to dial and make an outgoing call.
- 2 Once completed the dialing, [CALLING] is displayed.

To redial number

- 1 Press **CALL** on front panel to redial.
- 2 Press **CALL**, unit will display [CALLING], and the unit starts dialing the number dialed last time.

Remark:

To make an outgoing call on this unit, the bluetooth connection between the unit and the phone must be active.

Receiving a Call

- 1 If there is incoming call, the phone number is displayed. if the incoming call has no phone number, [PHONE IN] is displayed.
- 2 Press **CALL** to answer / accept the call.
- 3 When conversation ends, press **CALL** to terminate the call.

Call Transfer

You can transfer voice from loudspeaker to mobile phones during call.

During talking, press and hold **CALL** voice transfers from loudspeaker to mobile phone.

Bluetooth Audio Streaming A2DP

If the connected Bluetooth device supports Advanced Audio Distribution Profile (A2DP), you can listen to the music stored on the device through the unit. If the device also supports Audio Video Remote Control Profile (AVRCP) profile, you can use the control on the unit or its remote control to play music stored on the device.

- 1 Press **SRC** repeatedly to select [BT AUDIO].
- 2 Press **PLAY** to start play, press it again to pause.
- 3 To track up/down, press **PREV** / **NEXT**.

Remote Control Operation

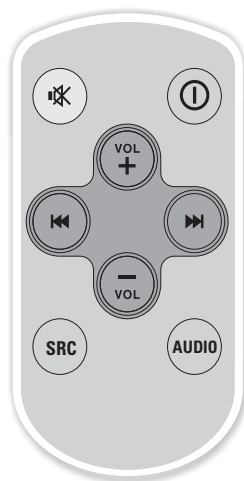

When you press or hold the following button(s)...

Main unit	General operation
	Turn mute or restore volume.
	Press turn the unit on or off.
	Press increase the volume.
	Press decrease the volume.
	<ul style="list-style-type: none"> ■ Under Radio mode to enter into the Auto Seek mode, press and hold to enter into the Manual Seek mode. ■ Under Media playback mode to skip track / file, press and hold to fast forward / backward.
SRC	Select the available sources (Radio, Disc, USB , SD, BT AUDIO or Aux-In), if the power is turned on.
AUDIO	Press to access into the Audio Menu mode.

Product Information

General

Power Supply: 12V DC (10.5-14.4V), negative ground
Fuse: 15A
Suitable Speaker Impedance: 4-8Ω
Aux-In level: 500mV

Audio Section

Maximum Power Output: Mosfet 50W x 4 Channels
Continuous Power Output: 24W x 4 RMS
Pre-AMP Output Voltage: 5V
Subwoofer Output Voltage: 5V (Subwoof Vol Max=12)

FM tuner section

Frequency Range: 87.5 - 108MHz
Usable Sensitivity: Better than 15dB at S/N 30dB

AM tuner section

Frequency Range: 522 - 1620KHz
Usable Sensitivity: Better than 45dB at S/N 26dB

USB devices

USB Flash Memory: USB 1.1 & 2.0 Compatible

Memory Card

Support type of memory card: SD/SDHC

Bluetooth

Output power: 0dBm (Class II)
Frequency band: 2.4000GHz-2.4835GHz ISM Band
Range: 3 meters (free space)
Standard: Bluetooth 2.0 specification

About Audio file

- USB or memory file system: FAT16, FAT32
- MP3/WMA bit rate: 32-320kbps and variable bit rate
- MP3 sampling frequencies: 8-48kHz
- WMA sampling frequencies: 32kHz, 44.1kHz, 48kHz
- ID3 tag v1.0 or later



 Nakamichi®

www.nakamichiasia.com