

GATER 

GTV22DVD

22" COLOUR TV+

INBUILT DVD PLAYER



USER MANUAL





TABLE OF CONTENTS

IMPORTANT SAFETY INSTRUCTIONS	4
PACKAGE CONTENTS	6
LOCATION AND FUNCTION OF CONTROLS	7
FRONT PANEL	7
CONTROL BUTTONS AND TERMINALS	8
REAR PANEL	8
SIDE PANEL	8
REMOTE CONTROL	9
BATTERY INSTALLATION	11
BASIC CONNECTIONS	12
CONNECTING POWER CORD	12
CONNECTING THE RF CABLE	12
CONNECTING TO AV OUT	13
CONNECTING TO COMPONENT VIDEO TERMINAL	14
CONNECTING TO YPbPr TERMINAL	14
CONNECTING TO HDMI INPUT CONNECTOR	15
CONNECTING TO A PC	15
CONNECTING TO A HEADPHONE	16
CONNECTING TO COAXIAL OUTPUT	16
BASIC OPERATION	17
SELECTION ON SCREEN LANGUAGE	17
CHOOSING TV CHANNEL	17
SELECTING INPUT SOURCE	17
FIRST TIME INSTALLATION	18
CHANNEL MENU	20
AUTO TUNING	21
DVB-T Auto Scan Menu	21
DVB-T Manual Tuning	22
ATV Manual Tuning	22
DVB-C AUTO Tuning Menu	23
DVB-C Manual Tuning	24
Program Edit	24
Signal Information	26
CI Information	26
5V antenna power	26

LCN -----	26
Software Update (USB)-----	26
CHANNEL MENU (SATELLITE) -----	27
AUT O TUNING -----	27
DVB-S Manual Tuning-----	28
Program Edit-----	29
Satellite edit -----	30
PICTURE MENU -----	32
Picture Mode -----	32
Color Temperature -----	32
Aspect Ratio -----	33
Noise Reduction-----	33
Dynamic CR-----	33
SOUND MENU -----	34
Sound Mode -----	34
Balance -----	34
Auto Volume -----	34
Surround Sound-----	34
SPDIF Mode -----	35
AD Switch -----	35
Main Speakers-----	35
TIME MENU -----	36
Clock -----	36
Off time -----	37
On time -----	37
Sleep timer-----	38
Auto standby -----	38
Time Zone -----	38
OSD timer -----	38
OPTION MENU-----	39
OSD Language -----	39
Audio Language -----	40
Subtitle Language -----	40
Hearing Impaired -----	40
PVR File system -----	40
Reset -----	40
HDMI CEC -----	41

First time installation -----	41
ECO Mode -----	42
Blue screen -----	42
LOCK MENU -----	43
Lock System -----	44
Set Password -----	44
Block Program -----	44
Parental Guidance -----	44
Key Lock -----	44
HOTEL MENU -----	44
Hotel Mode-----	44
Source Lock -----	44
Default Source-----	44
DTV Channel Type-----	44
Default Prog.-----	44
Max Volume -----	44
Default Volume -----	44
Clear Lock-----	44
COPY DATA TO USB-----	44
LOAD DATA FROM USB-----	44
EPG MENU -----	45
TIME SHIFT -----	45
RECORDED LIST -----	46
CHANNEL LIST -----	46
MEDIA OPERATION -----	47
Photo Menu-----	47
Music Menu -----	49
Movie Menu-----	50
Text Menu -----	51
DVD BASIC OPERATION -----	53
DVD REMOTE CONTROL OPERATION -----	54
DVD SETUP -----	57
SUPPORTED OPERATING MODES -----	63
TROUBLE SHOOTING -----	64
SPECIFICATIONS -----	65
STAND INSTALLATION -----	68
TECHNICAL ASSISTANCE -----	69

IMPORTANT SAFETY INSTRUCTIONS

	CAUTION RISK OF ELECTRIC SHOCK DO NOT OPEN		TO REDUCE THE RISK OF ELECTRIC SHOCK. DO NOT REMOVE COVER. NO USER-SERVICEABLE PARTS INSIDE. REFER SERVICING TO QUALIFIED SERVICE PERSONNEL.
	This symbol indicates "dangerous voltage" inside the product that presents a risk of electric shock or personal injury.		This symbol indicates important instructions accompanying the product.

Read this Manual

Read this manual thoroughly before operating the unit.

Keep this manual

Keep this manual for future reference.

Observe all warnings

All warnings on the product and in the manual must be observed closely.

Follow all instructions

All operating instructions in the manual must be followed.

Do not insert liquids or objects

Liquids or objects could result in fire or electrical shock. Use special caution in households where children are present. If liquids or objects should enter the LED TV, immediately turn off the power switch, disconnect the power plug from the AC outlet and contact the qualified service personnel.

- Do not place the LED TV near the bathtub, bathroom, kitchen sink, wet basement or swimming pool, and the like.
- Do not expose the LED TV to rain or moisture.
- Do not place flower vases, pots, cups, cosmetics, liquids as water, etc on or around the LED TV.
- Do not place metals, combustibles, etc on or around the LED TV.
- Do not drip or splash liquid of any kind on the LED TV.

Do not give the LED TV any shock or impact

If the LED TV should be dropped and/or broken, it could result in an injury, and continued use could result in fire or electrical shock.

If the glass panel is broken or damaged, immediately turn off the power switch, disconnect the power plug from the AC power outlet and contact the qualified service personnel.

Prevent the unit from falling

- Fasten the LED TV to a wall using a cord or chain which is sufficient to support the weight of the LED TV. Before moving the LED TV, the cord or chain should be removed.
- Do not allow children to climb on the LED TV.
- Do not place the LED TV on a bed, sofa, rug, similar surface. Do not place the LED TV on an unstable cart, stand, or table. The LED TV may fall, causing serious damage to the LED TV and/or serious personal injury, death.
- When the product is used on a trolley, care should be taken to avoid quick stops, excessive force, and uneven surfaces that may cause the product and trolley to overturn.

IMPORTANT SAFETY INSTRUCTIONS

Do not block any ventilation openings

- The vents and other openings in the cabinet are designed to let hot air escape from the LED TV. Do not cover or block these vents and openings since insufficient ventilation can cause overheating. Do not place the LED TV on a bed, sofa, rug or other similar surface, since they can block ventilation openings, it may overheat and result in fire.
- Do not cover the LED TV with cloth, such as curtains, or items such as news paper, etc.
- This unit is not designed for built-in installation, do not place the product in an enclosed place such as a bookcase or rack, unless proper ventilation is provided or the manufacturer's instructions are followed.

Avoid high temperature environment

The heat adversely affect the LED TV and other parts, and could result in serious overheating or risk of fire.

- Do not place the LED TV, the remote control and other parts in direct sunlight or near a hot object such as heater, etc.
- Do not put the LED TV in a place where the temperature is widely changing.
- **To prevent the spread of fire, keep candles or other open flames away from this product at all times.**

Avoid oils

Do not install the LED TV in a place that uses oil. Dust absorbing oil may enter into the unit and damage the unit.

Power cord protection

Incorrect connection of the power cord could result in fire or electrical shock.

- Do not connect too many appliances to the same mains socket as this could result in fire or electrical shock.
- The apparatus shall be connected to a mains socket outlet with a protective earthing connection.
- The socket outlet for connecting mains plug shall be easily accessible and remain readily operable.
- Do not overload wall outlet as this can result in fire or electrical shock.
- Check that the connecting portion of the AC power cord is clean (with no dust), before using. Use a soft and dry cloth to clean the power plug.
- AC power cord should be routed so that they are not likely to be walked on or pinched by items placed upon or against it. Also do not put any heavy objects on the AC power cord.
- Do not touch the AC power cord with a wet hand.
- Pull out the AC power cord by the plug. Do not pull on the power cord.
- Insert the power plug into a power outlet firmly. Avoid using a loose, or damaged outlet.
- Do not pinch, bend, or twist the cable excessively. The core lines may be bared or cut, causing a short-circuit which may induce fire or electrical shock.
- For your own safety, do not touch any part of the unit, power cord or aerial lead during lightning storms.
- Do not modify the AC power cord.
- Disconnect the power cord if the LED TV is not used for a long time.
- Switch off and withdraw the power plug before making or changing connections.
- The mains plug is used as disconnect device, the disconnect device shall remain readily operable.

Handling and cleaning the screen surface of display unit

To avoid screen degradation, follow points mentioned below. Do not push on or scratch with hard objects, or throw anything at the screen. The screen may be damaged.

- Be sure to unplug the power cord from outlet before cleaning.
- Do not touch the display panel after operating continuously for a long period as the display panel becomes hot.
- We recommend that the screen surface is touched as little as possible.
- To remove dust from the screen surface, wipe gently with a clean, soft and cotton-free dry cloth.
- Do not use any type of abrasive pad, alkaline/acid cleaner or strong solvent such as alcohol, thinner or benzene etc, as the surface may be impaired.

Cleaning the cabinet

- Be sure to unplug the power cord from the outlet before cleaning.
- Clean the cabinet with a soft cloth.

IMPORTANT SAFETY INSTRUCTIONS

- Note that material deterioration or screen coating degradation may occur if the display unit is exposed to a volatile solvent, such as alcohol, thinner, benzene or insecticide, or if prolonged contact is maintained with rubber or vinyl materials.

Carrying and moving

- Be sure to always carry the LED TV by two people holding it with two hands, one hand on each side of the LED TV. If you carry the unit in a manner other than that specified, it may drop and a serious injury may be caused.

Servicing

Do not open the cabinet or remove the rear cover of the unit. If any of the following conditions occurs, unplug the AC power cord from the AC outlet, and contact qualified service personnel.

- When the power cord or plug is damaged.
- When the LED panel is damaged.
- When the liquid is spilled on the unit or when objects have fallen into the unit.
- When the unit has been exposed to rain or water.
- If the unit has been dropped or the cabinet has been damaged in any way.
- If the unit does not work properly even after you have referred to the **TROUBLESHOOTING** section.

Replacement parts

- In case the unit needs replacement parts, make sure that the service personnel uses replacement parts specified by the manufacturer, or those with the same characteristics and performance as the original parts. Use of unauthorized parts can result in fire, electrical shock and/or other danger.
- Upon completion of service or repair work, request the service technician to perform safety checks to ensure that the unit is in proper operating condition.

WARNING: Excessive sound pressure from earphones and headphones can cause hearing loss.

Other notices

- Sometimes, the image may have some tiny red, green, blue, white or black spots. This is normal and does not affect the performance of the LED TV.
- Due to advanced technology of the LED TV, giving you fine picture details. Occasionally, a few non-active pixels may appear on the screen as a fixed point of blue, green, or red. Please note that this does not affect the performance of your LED TV.
- If the unit is used in a cold place, a smear may occur in the picture or the picture may become dark. This does not indicate a failure. These phenomena improve as the temperature rises.
- In some case, residual images may remain after the short-term display of still images is displayed. These will disappear in a few minutes, and the display will return to normal. However, if used in high temperatures, it sometimes spends some tens of minutes to return to normal. Please note that this is not a malfunction.
- LED panel are made of finely processed glass, so please avoid pushing hands or a strong impact on the panel. It may cause damage to the LC cells, and/or there is danger of glass breakage.
- Do not use immediately after moving from a low temperature to a high temperature environment, as this causes condensation, which may result in fire, electrical shock or other danger.

PACKAGE CONTENTS

Your LED TV package includes:

- | | |
|-----------------------------------|---------------|
| 1. LED TV | 7. AC Adapter |
| 2. DC Power Cord | 8. Stand |
| 3. Remote Control + Batteries x 2 | 9. Screws x 2 |
| 4. Mini AV Conversion Cable | |
| 5. Mini YPBPR Conversion Cable | |
| 6. User Manual | |

Note:

Your product may also include various other accessories depending on region of purchase.

LOCATION AND FUNCTION OF CONTROLS

FRONT PANEL

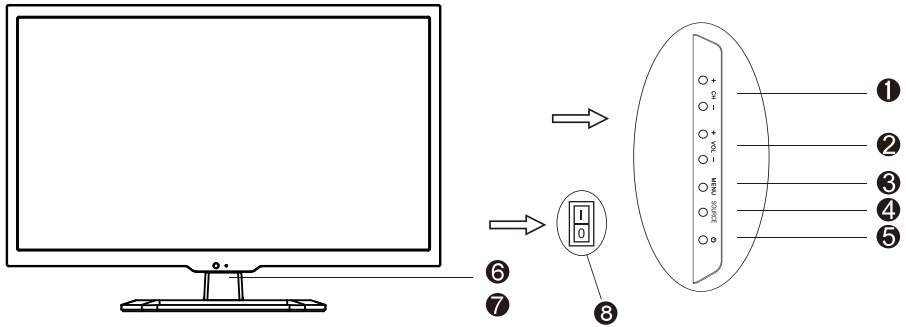

Item	Button Name	Description
①	CH+/-	When you are watching the TV program, press these buttons to select channel in ascending or descending order. Select the upper or lower menu item in the OSD menu.
②	VOL+/-	Increase or decrease the volume. Adjust the values of the selected menu item in the OSD menu.
③	MENU	Enter or exit from the menu.
④	SOURCE	Select an input signal.
⑤	⏻	Switch on the LED TV when at standby mode or vice versa.
⑥	Power Indicator	Illuminates blue in standby mode. No illuminates when the LED TV is switched on.
⑦	Remote Sensor	Infrared sensor for the remote control.
⑧	Main Power Switch	Switch on/off the LED TV.

💡 Note:

If there is no signal input for over 15 minutes, or no operation for over 180 minutes, the LED TV will switch to standby automatically, the power indicator will light up in blue.

CONTROL BUTTONS AND TERMINALS

REAR RANEL

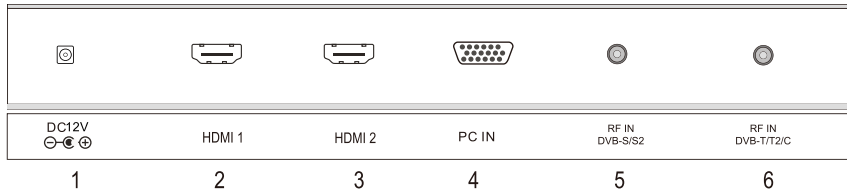

- 1. DC Terminal
- 2. HDMI Input Connector
- 3. HDMI Input Connector
- 4. PC IN Input Connector
- 5. RF IN
- 6. RF IN

SIDE PANEL

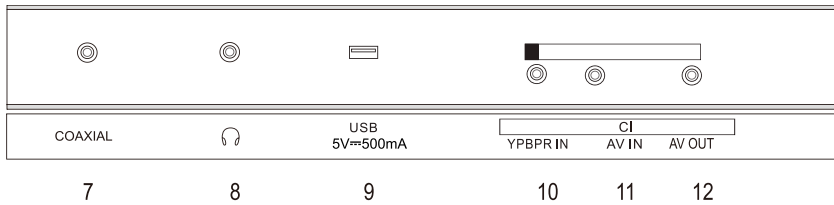

- 7. COAXIAL
- 8. Headphone Output Terminal
- 9. USB Input Terminal
- 10. YPbPr Input Terminal
- 11. AV Input Terminal
- 12. AV Output Terminal

Top View Of The AV/YPbPr Conversion Cable



● REMOTE CONTROL

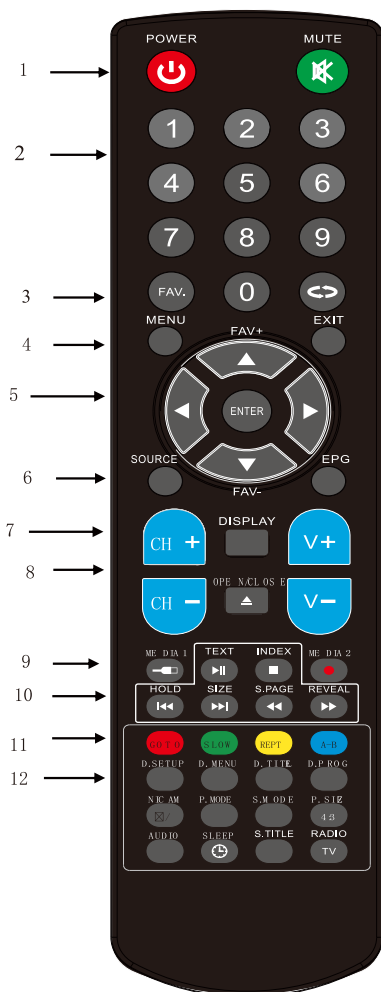

1. POWER

To switch on the LED TV when at standby mode or vice versa.

2.0-9 Number Buttons

Press any numbers 0-9. Then press Enter to select a channel input the password or the time and son on

3. FAV.

Start the “Favorite List ”

4. MENU

To enter or exit from the MENU.

5. ◀ ▶ ▼ ▲ and ENTER

Use to select on screen menu items and change menu values. Press ENTER can display Channel List

6. SOURCE

To select an input signal.

7.DISPLAY

To display the source and channel information.

8. CH+/-

To select the channel forward or backward.

9.MEDIA

To enter the USB multi-media.

10.TELTEXT Buttons

These buttons are used for certain modes with teletext functions only. For further details, refer to the TELETEXT FUNCTION.

11.Colour function Buttons

These Red/Green/Yellow/Blue buttons are used for certain modes with short key functions only. For further details, refer to the operation function.

12. D.SETUP

Note. In DVD mode to activate the DVD SETUP menu.

In DTV mode to activate the **Schedule List** menu.

D.MENU

During EVD playback, press to enter the program menu.

During USB media playback, press to enter the setup menu.

D.TITLE

During DVD playback, press to display the DVD title Menu.

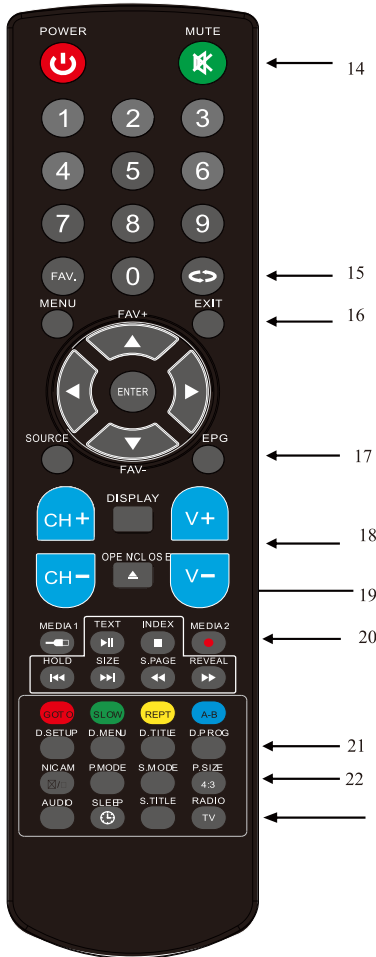

14. MUTE

To switch the sound on or off.

15.Return

To return to the previously selected program number

16.EXIT

To exit the menu.

17.EPG

To star the EPG Application

18.VOL+/VOL-

To adjust the audiol levels

19. OPEN/CLOSE

Press to open or close the disc tray.

20.MEDIA 2

Once button recording

21.D.PROG

While watching the digital TV, press to start time shift.
During DVD playback, press to display the program menu for edit.

22. NICAM

To switch among Stereo,DUAL1 DUAL2 and MONO in ATV mode.

P.MODE

To select picture mode.

S.MODE

To select the sound mode.

P.SIZE/4.3

To select picture size

23. AUDIO

To select Stereo/MONO. or change a udio's language in DTV,USB and DVD mode.

SLEEP

To select sleep time.

S.TITLE

To enable/disable the subtitle in DTV,USB and DVD mode.

TV/Radio

To select TV and Radio in DTV mode.

CONTROL BUTTONS AND TERMINALS

BATTERY INSTALLATION

Insert the batteries while observing the correct (+) and (-) polarities as illustrated below.

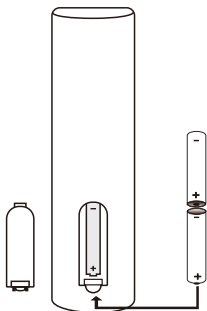

About the batteries

- If the remote control unit fails to work even when it is operated near the LED TV, please replace the batteries.
- Use size UM-4 (AAA) batteries.

💡 Note:

- Do not use rechargeable (Ni-Cd) batteries.
- Do not attempt to recharge, short circuit, disassemble, heat or throw the batteries into the fire.
- Do not splash the remote control with water or put it on a wet object to avoid possible.
- Do not drop, step on or cause any impact to the remote control unit. This may damage it, resulting malfunction.
- Do not mix old and new batteries.
- If the remote control unit is not going to be used for a long time, remove the batteries.
- Strong light such as direct sunlight impinging on the remote sensor can cause operational failure. Place the remote control to avoid direct contact with sunlight.

Caution

Keep batteries out of children's reach. If batteries are swallowed, contact a physician immediately.

BASIC CONNECTION

CONNECTING POWER CORD

1. Connect the AC/DC Adapter to the DC input socket on the rear of the LED TV, then plug the other end of the power cord into a correctly wall outlet.
2. Turn on the main power switch on the bottom of the LED TV, then press the POWER button on the remote control or the \odot button on the key pads to turn on the LED TV.

Note:

use only the AC/DC Adapter provided.

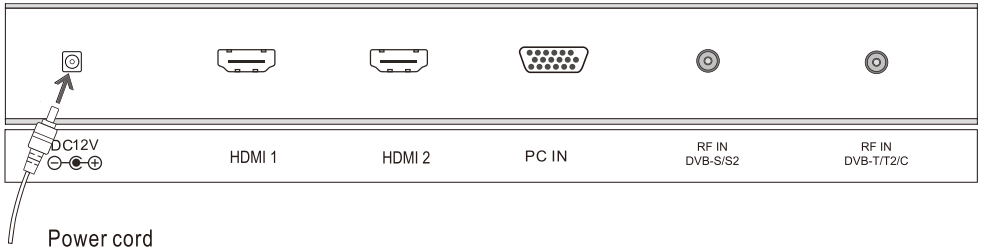

CONNECTING THE RF CABLE

Connect a 75 Ω aerial cable to the "RF IN" socket on the rear of the LED TV firmly.

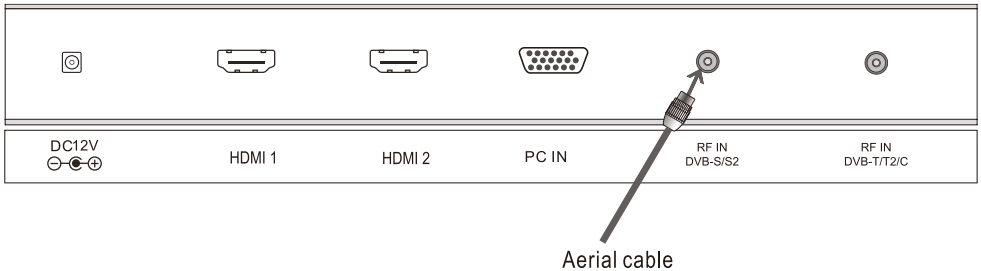

Note:

To view television channel correctly, a signal must be received by the set.

BASIC CONNECTION

- Before connecting any external video equipment, please familiarise yourself with the location and type of each input. If incorrect connections are made, picture or color quality may be adversely affected. Please ensure that all connectors firmly seated.
- Your external equipment such as DVD player, VCR or home theatre system can be connected to the rear of the LED TV so that you can enjoy a complete audio-visual experience.

💡 **Note:**

Before connecting any external equipment, turn off all main power switch or remove the mains plug from the AC outlet for safety.

CONNECTING TO AV OUT CONNECTOR

1. Connect the AV OUT connector on the external video device to the AV OUT connector on the LED TV using a AV OUT cable.

Yellow cable connector to V terminal(Yellow), White cable connector to L terminal(White), RED cable connector to R terminal(RED).

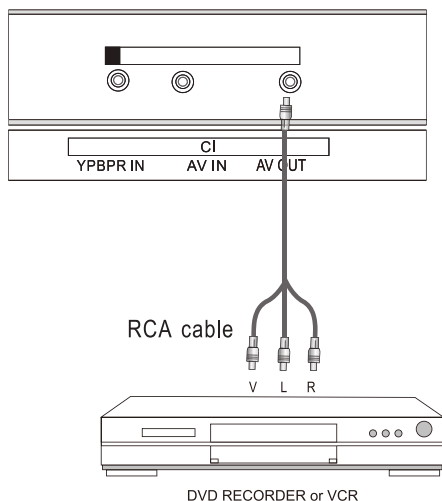

CONNECTING TO COMPOSITE VIDEO TERMINAL

1. Connect the video and audio signal with the AV Conversion cable and RCA cable.
2. Press the SOURCE button on the remote control to select **AV** input source, then press the ENTER button to perform your selection.

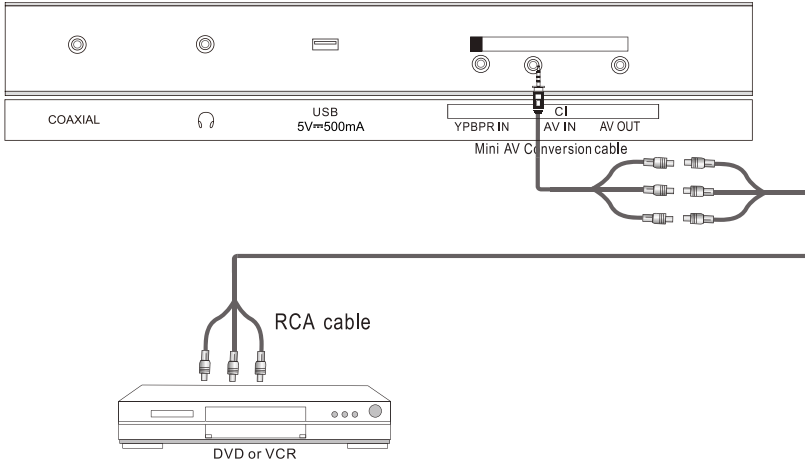

CONNECTING TO YPBPR TERMINAL

1. Connect the YPBPR signal with the YPBPR Conversion and YPBPR cable.
2. Connect the audio signal with the AV Conversion cable and RCA cable.
3. Press the SOURCE button on the remote control to select YPBPR input source, then press the ENTER button to perform your selection.

 **Note:** YPBPR's audio signal comes from the common AV IN terminal.

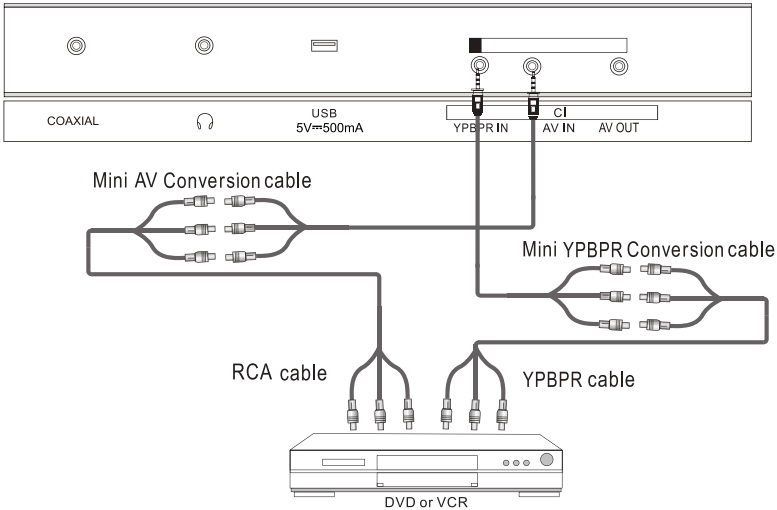

BASIC CONNECTION

CONNECTING TO HDMI CONNECTOR

HDMI (High-Definition Multimedia Interface) is the first all digital consumer electronics A/V interface that supports uncompressed standard. One jack supports both video and audio information.

This can be applied only if there is the HDMI output connector on the external equipment.

1. Connect an HDMI cable between the HDMI output connector on the LED TV and the DVD/ set-top-box.
2. Repeatedly press the SOURCE button on the remote control to select **HDMI** input source, then press the ENTER button to perform your selection.

💡 **Note:** No sound connection is needed for a HDMI connection.

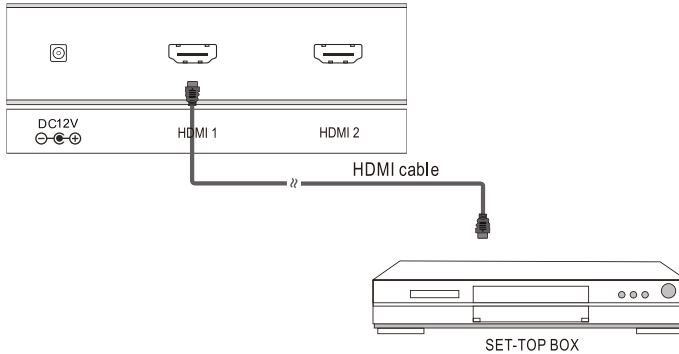

BASIC CONNECTION

CONNECTING TO A HEADPHONE

You can connect a headphone to your LED TV if you wish to watch a TV program without disturbing the other people in the room.

Insert a headphone into the 3.5mm mini-jack terminal on the LED TV, the sound is heard through the headphone.

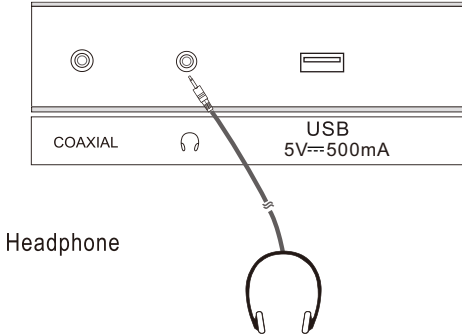

Note: Prolonged use of headphones at a high volume may damage your hearing.

CONNECTING TO COAXIAL OUTPUT

1. Connect the Coaxial cable from your Amplifier to Coaxial output of LED TV.
2. You can enjoy the audio from the TV via your home theater system.

Note: SPDIF output(OFF,PCM,AUTO)can be selected in **AUDIO MENU** setup.

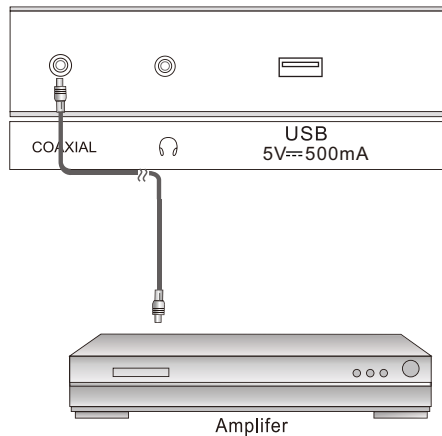

BASIC OPERATION

SELECTING ON SCREEN LANGUAGE

When you start using your LED TV for the first time, you must select the language which will be used for display menus and Indications.

1. Press the MENU button to display the menu.
2. Press the ◀/▶ button to select OPTION MENU.
3. Press the ▼/▲ button to select OSD Language item.
4. Then press the Enter button to select your language menu, Press the ▼/▲, ◀/▶ button to select OSD Language.
5. When you are satisfied with your choice, press the MENU button to return to normal TV viewing.

CHOOSING A TV CHANNEL

Press the CH+ or button to increase channel number.

Press the CH- or button to decrease channel number.

You can select the channel number directly by pressing 0 to 9 buttons three times.

Note:

After select the digit button, the digit will be memorized. You can return to the previously selected program by pressing.

SELECTING INPUT SOURCE

You can select the source by press the SOURCE button on the top of the panel or press the SOURCE button on the remote control. Then press ENTER to confirm.



FIRST TIME INSTALLATION

First Time Installation also can be activated in the SETUP menu.

Note: If you do First Time Installation and select Auto Tuning, all TV programs will be update, but you can select "Yes" to install the factory preset channel lists during the installation.

Select Language

Press ◀/▶ button on the remote control to select the language to be used for menus and message. Press ▼/▲ button on the remote control to highlight Country menu. Press ◀/▶ button on the remote control to select the country you want to.



Press ENTER button to enter Auto Tuning Setup.

TV Connection Setup

Press ◀/▶ to select tune type among Antenna ,Cable, Satellite.

Tune Type

Press ◀/▶ to select digital type among DTV, A TV and DTV+ATV.

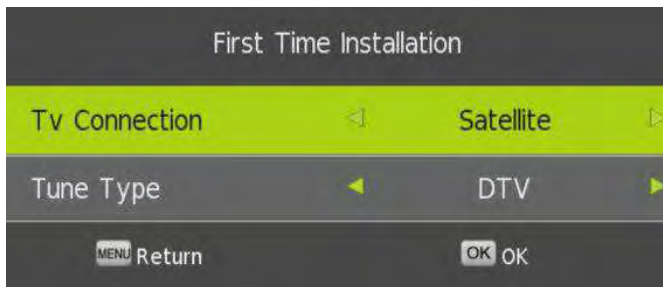

If you select DVB-S, then you must setup the Dish of the local satellite.

If you select Cable DVB-C, then you must setup the following items:

Tune Type

Press ◀/▶ to select tune type between DTV,ATV and DTV+ATV.

Scan Type

Press ◀/▶ to select scan type between Full and Network Scan.

Frequency

Press ◀/▶ to select frequency between Auto and 770000.

Network ID

Press ◀/▶ to select network ID between Auto and 65535.

Symbol(ks/s)

Press ◀/▶ to select symbol rate between Auto and 6900.

After confirming Tuning Setup by pressing ENTER button to channel tuning:

During channel tuning, you can press MENU and left arrow button on the remote control to skip tuning.

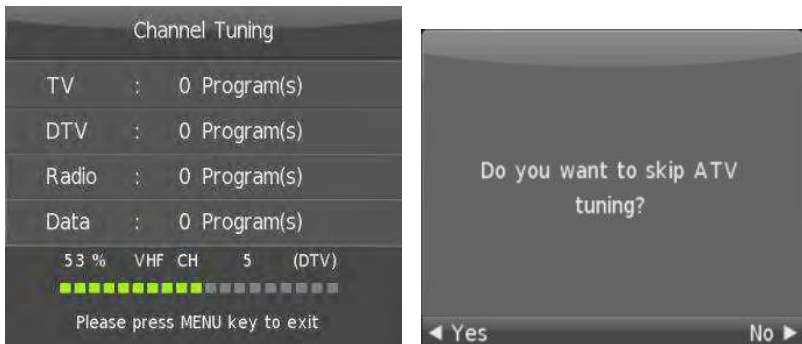
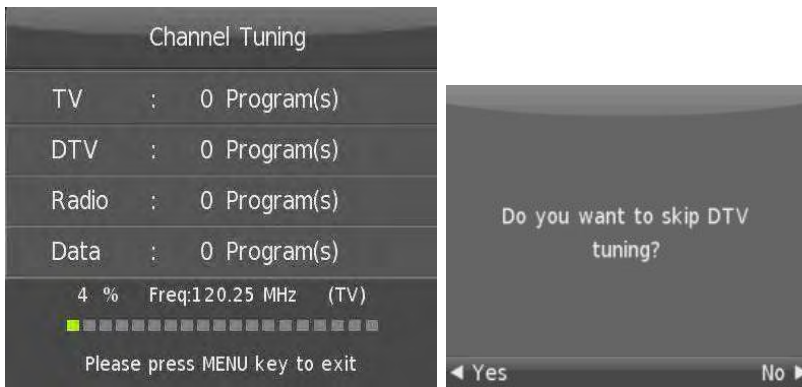

CHANNEL MENU

Press SOURCE button to select Antenna or Cable, **Satellite** ,ATV.

Press MENU button to display the main menu.

Press ◀/▶ button to select CHANNEL in the main menu.



Channel Menu (Antenna DVB-T ,CABLE,ATV)



Channel Menu (ATV, Satellite)

1. Press ◀/▶ button to select the option that you want to select in the CHANNEL menu.
2. Press ENTER button on the remote control to enter sub-menu.
3. Press MENU button to return back to the previous menu.

Auto Tuning

DVB-T Auto Scan Menu

Press ▼ button to select Auto Tuning, then press ◀/▶ button to enter and select tuner type.

Tuner Type

Press ◀/▶ button on the remote control to select tuner type:ATV+DTV, DTV, ATV.

Country

Press ▼ button on the remote control to enter country item, then press ▼/▲, ◀/▶ button to enter and select country. Press ENTER to Search.



DVB-T Manual Tuning

DTV Manual Tuning (DVB-T)

Press ▼ button to select DTV Manual Tuning, then press ENTER button to enter sub-menu.

Press ◀/▶ button to select channel, then press ENTER button to search program Manual

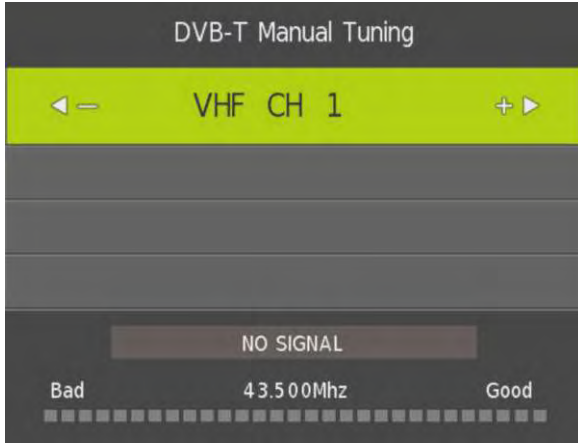

ATV Manual Tuning

Press ▼/▲ button to select ATV Manual Tuning, then press ENTER button to enter sub-menu, Press ▼/▲ button to select setup item

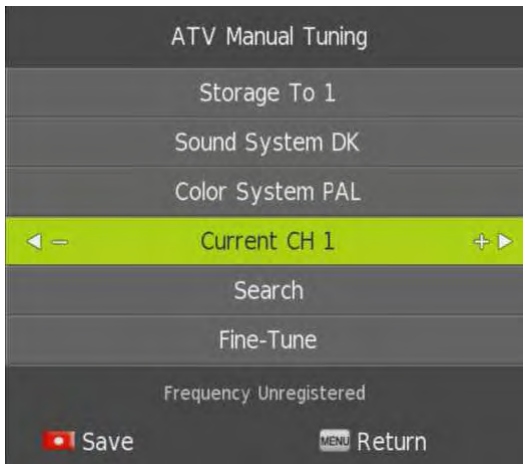

Storage To 1

Select the Storage channel number. Press ◀/▶ button to select channel number you want to store,

Sound System

Select the sound system (DK/BG/I). Press ▼/▲ button to select Sound System. Press ◀/▶ button to select option you want.

Color System

Select the color system (PAL/NTSC/SECAM). Press ▼/▲ button to select Color System. Press ◀/▶ button to select option you want.

Current CH

Set the channel number. Press ◀/▶ button to adjust a suitable tune that make you watch comfortably,

Search

Press ▼/▲ button to select search, then press Enter button to start tuning, Press ◀ to search down from the current frequency and press ▶ to search up

Fine-Turn

Adjust the frequency of the channel finely, Press ▼/▲ button to select Fine-Tune,

Press red button on your remote control to save the settings and menu button to hack to the previous menu.

Press MENU button to return back to the previous menu.

DVB-C Auto Tuning Menu

Press ▼/▲ button to select **Auto Tuning**, then press ENTER button to enter sub-menu.

Press ▼/▲ button to select setup item:

Scan Mode

Press ◀/▶ button on the remote control to select scan Mode: Full, Network Scan

Frequency

Press ◀/▶ button on the remote control to select frequency: Auto, 770000.

Network ID

Press ◀/▶ button on the remote control to select network ID: Auto, 65535.

Symbol (ks/s)

Press ◀/▶ button on the remote control to select network ID: Auto, 6900.

Press ENTER button to start tuning.



DVB-C Manual Tuning

Press ▼/▲ button to select DVB-C Manual Tuning, then press ENTER button to enter sub-menu.

Press ▼/▲ button to select setup item:

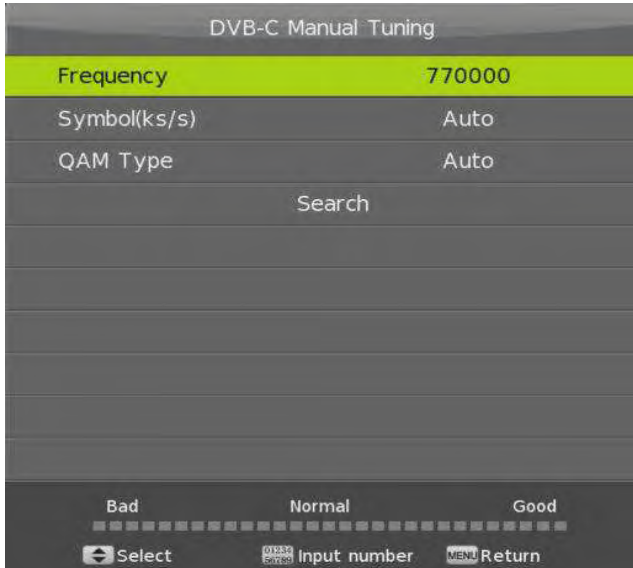

Frequency

Press ◀/▶ button on the remote control to select option you want.

Symbol(ks/s)

Press ◀/▶ button on the remote control to select option you want type: AUTO or 6900.

QAM Type

Press ◀/▶ button on the remote control to select QAM type: 16QAM,32QAM,64QAM,128QAM,256QAM.

Press ▼/▲ button to select **Search**, then press ENTER button to start tuning,

Program Edit

Note: Program Edit function is available only when the LCN is set to OFF .

Press ▼/▲ button to select Program Edit, then press ENTER button to enter sub-menu.

Press the four colored key is the shortcut key for function operation.

First press ▼/▲ to highlight the channel you want to delete or rename or move or skip, then:



Press the Red button to delete the channel.

Press the Yellow button to set the channel to moving state, then press ▼/▲ to move it to the position you want to put.

Press the Blue button to skip the select channel. (Your TV set will skip the channel automatically when using CH+/- to view the channels.)

Press the FAV button to add the channel to your favorite list.

Press the ▼/▲ button to page up or down the channel.



Signal Information

Press ▼/▲button to select Signal Information then press the ENTER button to see the detail information about the signal. Only available when there is signal under DTV.

CI Information

Press ▼/▲button to select CI Information then press the ENTER button to see the detail information about the signal. Only available when there is signal under DTV.

5V antenna power

Press ▼/▲button to select 5V antenna power . Press ◀/▶button to select On or OFF, about the signal. Only available when there is signal under DTV.

LCN

Press ▼/▲button to select LCN function . Press ◀/▶ button to select On or OFF, about the signal. Only available when there is signal under DTV.

Software Update (USB)

Press ▼/▲button to select Software Update function . Press ENTER button to Confirm update. Please prepare USB and relevant update files before software update. Then insert USB and choose this option. You should do according to system hint and remember not to pull out USB before finishing software update.

CHANNEL MENU (SATELLITE)

Channel Menu

Press SOURCE button to select **Satellite**.

Press MENU button to display the main menu.

Press ◀/▶ button to select CHANNEL in the main menu.



1. Press ▼/▲ button to select the option that you want to select in the CHANNEL menu.
2. Press ENTER button on the remote control to enter sub-menu.
3. Press MENU button to return back to the previous menu.

Auto Tuning

Press ▼/▲ button to select Auto Tuning, then press ENTER button to enter sub-menu.

Press ▼/▲ button to select function item.



Press ▼/▲ button to select Search ,Press “OK” to Search.

Satellite

Press ◀/▶ button to select Different types of satellites.

Channel Type

Press ◀/▶ button to select channel type: All ,Free, Scramble.

Service Type

Press ◀/▶ button to select service type: All, DTV, Radio.

Scan Mode

Press ◀/▶ button to select scan mode: AUTO, Blind Scan, Network, Preset, Fast Scan.

Note. Fast Scan is mainly for the countries Belgium, Netherlands, Luxemburg, Hungary and for a few customers in Germany and Austria.

Unicable

Press ◀/▶ button to select Unicable: Off, ON.

Search

Press **Enter** button to start Satellite auto scan .

Auto Tuning Status

Press ENTER button to start channel searching.

Press ◀ or EXIT button to tuning. Press Menu to exit tuning.

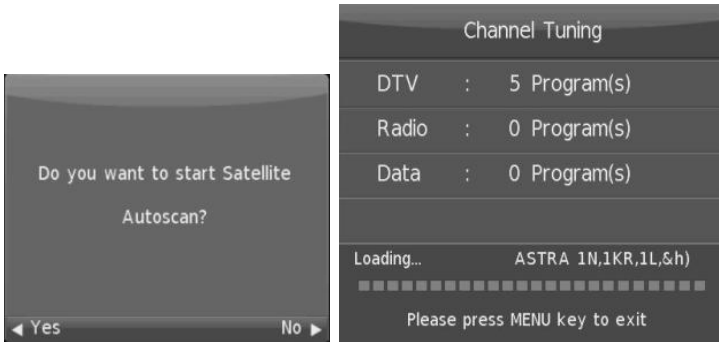

DVB-S Manual Tuning

Press ▼/▲ button to select DVB-S Manual Tuning, then press ENTER button to enter sub-menu.

Satellite

Press ◀/▶ button to select different types of satellites.

TransPonder

Press ◀/▶ button to select TransPonder

unicable

Press ◀/▶ button to select OFF,ON.

Network Scan

Press ◀/▶ button to select OFF, ON.

Scan Mode

Press ◀/▶ button to select scan mode ALL, Free, Scramble.

Service Type

Press ◀/▶ button to select Service Type: All, DTV, Radio.

Search

Press **ENTER** button to start Satellite Search .

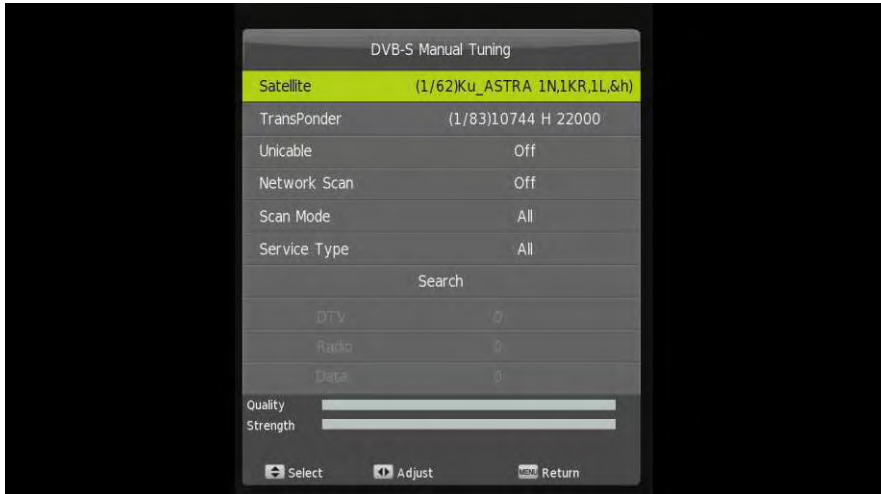

Program Edit

Press ▼/▲ button to select Program Edit, then press ENTER button to enter sub-menu.

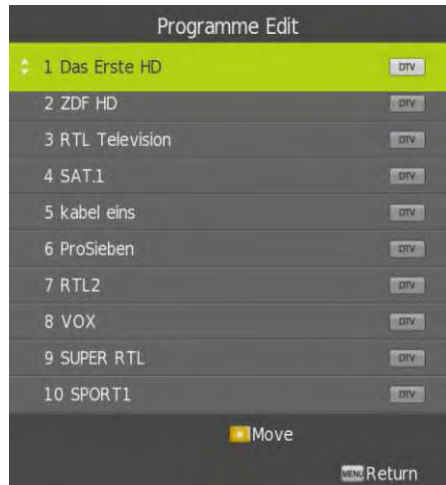

The colored key is the shortcut key for programming the channel.

First press ▼/▲ to highlight the channel you want to delete or move or skip, then:

Red

Press the **Red** button to delete the channel.

Yellow

Press the **Yellow** button to set the channel to moving state, then press ▼/▲ to move it to the position you want to put. You can also use the remote control input keys are free to enter the name you want to.

Blue

Press the **Blue** button to skip the select channel. (Your TV set will skip the channel automatically when using CH+/- to view the channels.)

FAV

Press the FAV button to add the channel to your favorite list.

Press the ◀/▶ button to page up or down the channel.

Satellite Edit

Press ▼/▲ button to select Program Edit, then press ENTER button to enter sub-menu.

First press ▼/▲ to highlight the channel you want to delete, then press Enter button to enter edit satellite sub-menu. Press the **Red** button to delete the **Satellite**.



Press the **Yellow** button to **add Satellite** menu.

Satellite	
Satellite Name	TELSTAR 18
Orbit Position	138.0 E
LNB Type	Universal
DiSEqC1.0	Off
DiSEqC1.1	Off
Tone 22KHz	AUTO
TransPonder	
Unicable Setting	Off
Motor	Off
Band	Ku
Input number	
 Select  Return	

Satellite	
Satellite Name	HOTBIRD 6,7A,8
Orbit Position	013.0 E
LNB Type	5750
DiSEqC1.0	Off
DiSEqC1.1	Off
Tone 22KHz	AUTO
TransPonder	
Unicable Setting	Off
Motor	Off
Band	Ku
Input number	
 Select  Return	

Press ▼/▲ button to select parameter settings, then press ENTER button to enter sub-menu.

Satellite Name

Press digital key to input you want satellite name .

Orbit Position

Press digital key to input Orbit Position

LNB Type

Press ◀/▶ button to select LNB Type: Universal, 5150, 750, 750, 0600, 0750, 1250, 1300, 1475, 150/5750, 50/10700, 750/10750, 0000/10450.

DiSEqC1.0

Press ◀/▶ button to select OFF,LNB1,LNB2,LNB3,LNB4.

DiSEqC1.1

Press ◀/▶ button to select OFF, LNB1, LNB2, LNB3, LNB4, LNB5, LNB6, LNB7, LNB8, LNB9, LNB10, LNB11, LNB12, LNB13, LNB14, LNB15, LNB16.

Tone 22kHz

Press ◀/▶ button to select OFF, ON,AUTO.

TransPonder

Press ENTER to TransPonder.

Press Short key Yellow to add TransPonder. press Short key Red to delete TransPonder.

Unicable Setting

Press ENTER to Unicable Setting

Press ◀/▶ button to select OFF, ON.

Motor

Press ◀/▶ button to select OFF, DiSEqC1.2, DiSEqC1.3.

Band

Press ◀/▶ button to select Ku, C.

PICTURE MENU

Press MENU button in the remote control to display the main menu.

Press ◀/▶ button on the remote control to select PICTURE in the main menu.

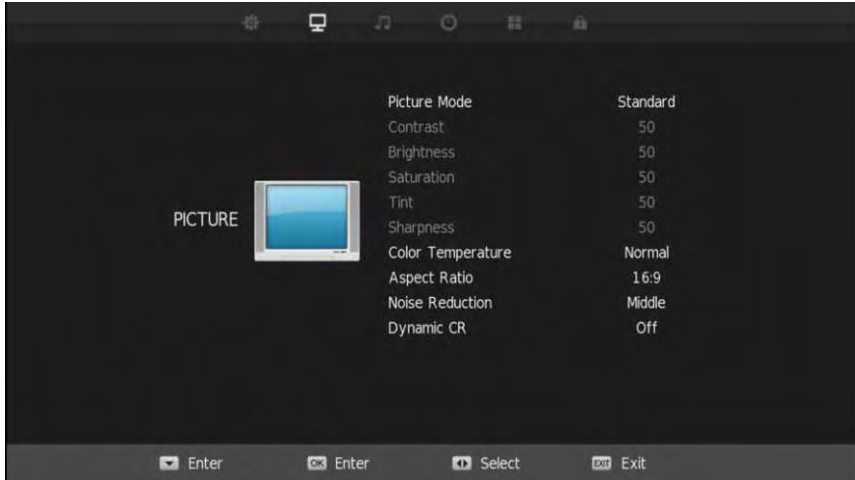

1. Press ▼/▲ button on the remote control to select the option that you want to adjust in the PICTURE menu.

2. After finishing your adjustment, Press MENU button to save and return back to the previous menu.

Picture Mode

Press ▼/▲ button to select Picture Mode.

Press ◀/▶ button to select (Available Picture mode: Dynamic, Standard, Mild, Personal).

You can change the value of contrast, brightness, color and sharpness when the picture is in Personal mode.

TIPS: You can press PMODE button on the remote control to change the Picture Mode directly.

Contrast/ Brightness/ Saturation/ Tint/ Sharpness

Press ▼/▲ button to select option, Press ◀/▶ button to adjust.

Contrast Adjust the highlight intensity of the picture, but the shadow of the picture is invariable.

Brightness Adjust the optical fiber output of the entire picture, it will effect the dark region of the picture.

Saturation Adjust the saturation of the color based on your own like.

Tint Use in compensating color changed with the transmission in the NTSC code.

Sharpness Aadjust the peaking in the detail of the picture.

Color Temperature:

Press ▼/▲ button to select option, Press ◀/▶ button to adjust. Increase or reduce warm color of the picture

personally(red),and the cool color personally(blue) according to your like.

Cool Increase the bluetone for the white,

Normal Increase the sex-linked colors for the white,

Warm Increase the red color for the white.

Aspect Ratio

Press ▼/▲button to select option, Press ◀/▶ button to adjust.

You can select **Auto, 16:9, 4:3, ZOOM1 or ZOOM2** with left and right keys when the option of Aspect Ratio is picked.

TIPS: You can press P.SIZE button on the remote control to change the **Aspect Ratio** directly.

Noise Reduction

Press ▼/▲button to select option, Press ◀/▶ button to adjust.

Set options to reduce video noise. Only VGA/HDMI is not available.

Off Select to turn off video noise detection.

Low Detect and reduce low video noise.

Middle Detect and reduce moderate video noise.

High Detect and reduce enhanced video noise.

The value of These options including contrast, Brightness, sharpness, saturation can adjust with arrow keys only in the user mode.

Dynamic CR

Press ▼/▲button to select option, Press ◀/▶ button to adjust..

You can select ON or OFF

SOUND MENU

Press MENU button on the remote control to display the main menu.

Press ◀/▶ button on the remote control to select SOUND in the main menu.

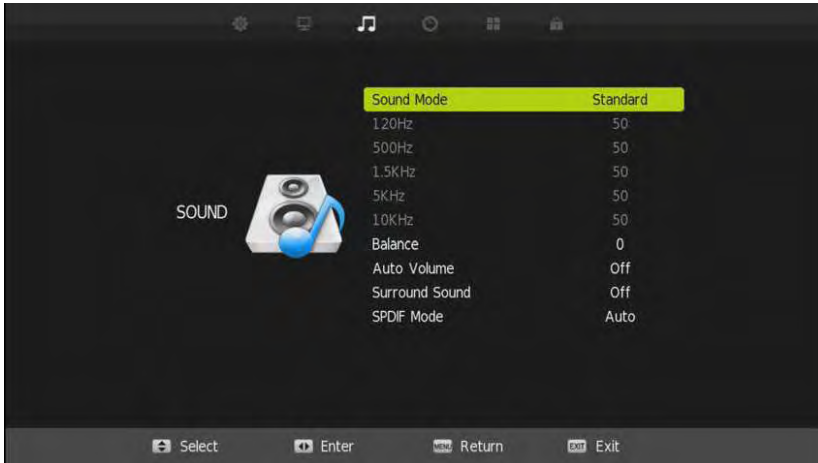

1. Press ▼/▲ button on the remote control to select the option that you want to adjust in the SOUND menu
2. After finishing your adjustment, Press MENU button to save and return back to the previous menu.

Sound Mode

Press ▼/▲ button to select Sound Mode, Press ◀/▶ button to select (Available Sound mode: Standard, Music, Movie, Sports, User).

You can change the value of Treble and Bass when the sound is in User mode.

The other item Only when the sound mode is user can you adjust items. Please choose the specific frequency and modify its value by left or right keys.

TIPS: You can press SMODE button on the remote control to change the Sound Mode directly.

Balance

Press ▼/▲ button to select option, Press ◀/▶ button to adjust.

It enables you to listen to best at your position, by adjusting the speaker's balance.

Auto Volume

Press ▼/▲ button to select Auto Volume Level, then press ◀/▶ button to select On or Off.

It is used for reducing the difference between channel and program's volume automatically.

Surround Sound

Press ▼/▲ button to Surround Sound, then press ◀/▶ button to select Surround or Off.

SPDIF Mode

Press ▼/▲ button to select Digital Output, then press ◀/▶ button to select Off / PCM /Auto.

AD Switch

Press ▼/▲ button to select AD Volume, then press ◀/▶ button to increase volume of the Audio description.

Main Speakers

Press ▼/▲ button to select Main Speakers, then press ◀/▶ button to select On/Off.

If the setting is "On", the main speaker is not automatically switched off when Earphone or BT connected. You can use the remote controller to mute the sound of the Earphone, BT and the main speaker at the same time.

If the setting is "Off", the main speaker is automatically switched off when Earphone or BT connected. You can use the remote controller to mute the sound of the Earphone and BT, but the speaker keeps mute except that you unplug the earphone and disconnect the BT device.

TIME MENU

Press MENU button on the remote control to display the main menu.

Press ◀/▶ button on the remote control to select TIME in the main menu.



1. Press ▼/▲ button on the remote control to select the option that you want to adjust in the TIME menu.

2. After finishing your adjustment, Press MENU button to save and return back to the previous menu.

Clock

Press ▼/▲ button to select clock, then press ENTER button to enter sub-menu.

Press ▼/▲/◀/▶ button. You can adjust data, month, year and so on with left and right keys.



Off time

Press ▼/▲ button to select Off time, then press ENTER button to enter sub-menu.

Press ◀/▶ button You can adjust specific settings. For off time, you can choose Off, Once, Every Day, Mon~Fri., Mon.~Sat., Sat.~Sun. and Sunday mode. Press ▼/▲ button select Hour Minute ,The hour and minute can change at random.

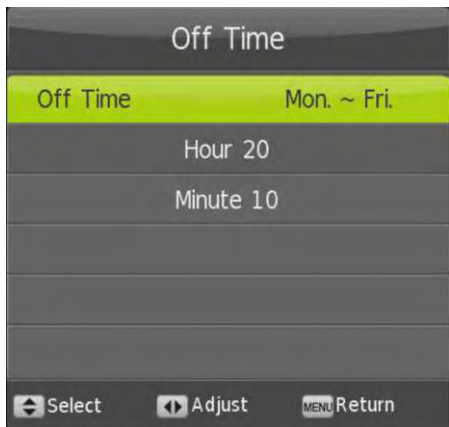

On time

Press ▼/▲ button to select On time, then press ENTER button to enter sub-menu.

Press ◀/▶ button You can adjust specific settings. For off time, you can choose Off, Once, Every Day, Mon~Fri., Mon.~Sat., Sat.~Sun. and Sunday mode. Press ▼/▲ button select Hour Minute Antenna DTV Channel Volume, The Parameter settings can change at random.

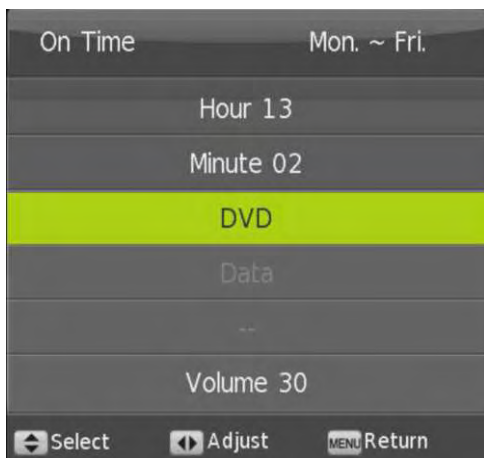

Sleep timer

Press ▼/▲ button to select Sleep timer, Press ◀/▶ button Choose option of Sleep timer and press right key to alter sleep timer value. The system provides specific values that the min. value is 10 minutes and max. value is 240 minutes.

Auto standby

Press ▼/▲ button to select Auto standby, Press ◀/▶ button Choose option of auto standby and press right key to alter auto standby value. You can alter it to Off/3H/4H/5H. You also can close the function of auto standby.

Time Zone

Press ▼/▲ button to select Time Zone, then press ENTER button to enter sub-menu.

Press ▼/▲/◀/▶ button to select time zone.

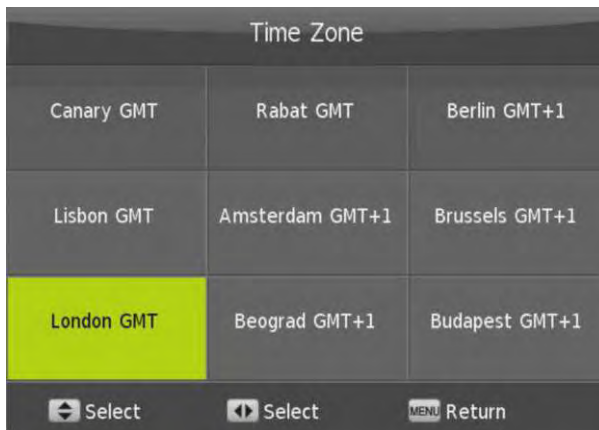

OSD timer

Press ▼/▲ button to select OSD timer, Press ◀/▶ button Choose option of OSD exit timer and press right key to alter value with left and right keys. The min value is 10s and the max value is 60s.

OPTION

Press MENU button on the remote control to display main menu.

Press ◀/▶ button on the remote control to select Option in the main menu.



1. Press ▼/▲ button on the remote control to select the option that you want to adjust in the OPTION menu.
2. Press ENTER button on the remote control to adjust.
3. After finishing your adjustment, Press OPTION button to save and return back to the previous menu.

OSD Language

Press ▼/▲ button to select OSD Language, then press ENTER button to enter sub-menu.

Press ▼/▲/◀/▶ button Choose the language of OSD, **Audio**, **Subtitle** can be modified in this part. First, you should select the concerned option and press ENTER button to enter language list. The arrow keys can help you choose what you want.



Audio Language

Press ▼/▲button to select Audio Language, then press ENTER button to enter sub-menu.

Press ▼/▲/◀/▶ button to Choose.

Subtitle Language

Press ▼/▲button to select Subtitle Language, then press ENTER button to enter sub-menu.

Press ▼/▲/◀/▶ button to Choose.

Hearing Impaired

Press ▼/▲button to select hearing impaired, press ◀/▶ button Choose the ON,OFF.

PVR File system

Press ▼/▲button to select PVR File system, then press ENTER button to enter sub-menu.

Press ◀/▶ button Choose the address of PVR file and check PVR system. Press ▼/▲button can Parameter settings ,The PVR file system can set as FAT32/FAT 64. After setting PVR file system size, you are able to start PVR.



Reset

Press ▼/▲button to select **Reset**, then press ENTER button to enter sub-menu.

Press ◀ button Choose “Yes” to reset, press ▶ button Choose “No” to exit.

After selecting the option of reset and pressing OK button, you can find a prompt box for confirming reset.

Please note that the reset will influence your previous setting.

HDMI CEC

Press ▼/▲button to select HDMI CEC, then press ENTER button to enter sub-menu.

Press ◀/▶button select to ON, Choose the function of HDMI CEC can get your life intelligent and convenient. you should open the function of HDMI ARC, Auto standby, Auto TV on, device control at your willing.



First time installation

Press ▼/▲button to select First time installation, then press Enter button to enter sub-menu.

press ENTER button to enter setting interface. The options you can modify include OSD language, country, and TV connection. You should press OK button to make sure your setting.

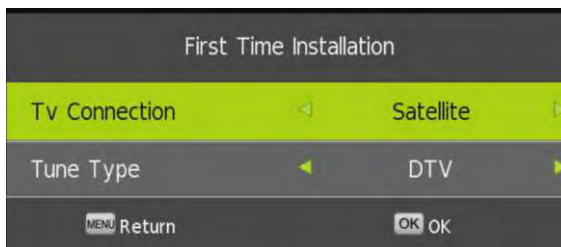
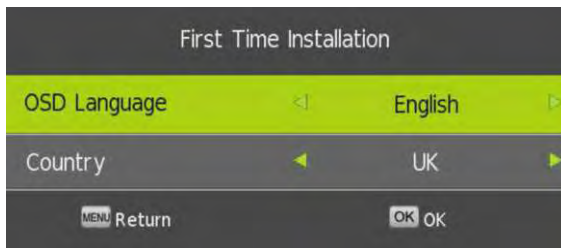

ECO Mode

Press ▼/▲ button to ECO Mode, then press ◀/▶ button to select Off, Low, Middle or High.

The system provides three ECO modes including low, middle, high. And the function of blue screen can be open or closed with right keys.

Blue screen

Press ▼/▲ button to Bleu screen, then press ◀/▶ button to select Off or On.

LOCK MENU

Lock

Press MENU button on the remote control to display the main menu.
Press ◀/▶ button on the remote control to select Lock in the main menu.



1. Press ▼/▲ button on the remote control to select system lock in the Lock menu.
2. Press ENTER button on the remote control to enter the sub-menu.
3. After finishing your adjustment, Press MENU button to save and return back to the previous menu.

Lock System

Press ▼/▲ button to select Lock System, then press Enter button to make the following options valid.(Default password is '0000').



Set Password

Press ▼/▲ button to select Set Password, then press ENTER button to enter sub-menu to set new password.

Block Program

Press ▼/▲ button to select Block Program, then press ENTER button to enter sub-menu to select. Press short key Green to lock to channel, Press green key again, cancel the lock function.

Parental Guidance

Press ▼/▲ button to select Parental Guidance, The grade of parental guidance ranges from Off or 4 to 18. Please pay attention that you can't do specific operation after opening key lock.

Key Lock

Press ▼/▲ button to select Key Lock, then press ◀/▶ button to select Off or On.

When Key Lock's status is on, you can't use the Key panel button.

Hotel Menu

Press MENU button to display the main menu on the remote control.

Press ◀/▶ button on the remote control to select Lock in the main menu.

1. Press ▼/▲ button on the remote control to select hotel mode in the Lock menu.
2. Press ENTER button on the remote control to enter the sub-menu.
3. After finishing your adjustment, Press MENU button to save and return back to the previous menu.

Hotel Mode

Press ▼/▲ button to select Hotel Mode, then press ◀/▶ button to select On or Off.

Source Lock

Press ▼/▲ button to select Source Lock, then press Enter button to enter sub-menu to select lock source.

Default Source

Press ▼/▲ button to select Default Source, then press ◀/▶ to select Off, Antenna, Cable, Satellite, ATV, AV, YPbPr, DVD, PC, HDMI 1, HDMI 2, Media.

DTV Channel Type

Press ▼/▲ button to select **DTV Channel Type**, then press ◀/▶ to select DTV, Radio.

Default Prog.

Press ▼/▲ button to select Default Program, then press ◀/▶ button to adjust last, 1, 2, 3, 4, 5.

It is available when the default source is TV.

Max Volume

Press ▼/▲ button to select Max Volume, then press ◀/▶ button to adjust Off, from 1 to 100.

Default Volume

Press ▼/▲ button to select Default Volume, then press ◀/▶ button to adjust from 0 to 100.

Clear Lock

Press ▼/▲ button to select Clear Lock, then press ENTER button to clear the setting you have done before.

COPY DATA TO USB

Press ▼/▲ button to select copy data to USB, then press ◀/▶ button to copy TV set data to USB.

LOAD DATA FROM USB

Press ▼/▲ button to select copy USB data to TV set, then press ◀/▶ button from USB load data to TV set.

EPG MENU

Press the EPG button in the remote control to enter EPG menu.

PROGRAMME GUIDE			
07 Dec 2005	05:30 - 09:00	07 Dec 2005	08:35
No information			
07 Dec			
1	YLE TV1	05:30-09:00	No information
2	YLE TV2	09:00-10:39	No information
3	YLE FST	10:40-11:13	Itsenäisyyspäivän paraati Lahdessa
4	YLE24	11:15-12:08	Tänään otsikossa
5	YLE Teema	12:10-13:00	Tohtori Ben Casey
1	YLE PEELI	13:00-13:29	Rakkauksia
2	YLEQ	13:30-13:33	Årets idrottare 2005: röstas fram
3	YLEN KLASSINEN	13:35-14:54	Estradilla: Aikamiehet 40 vuotta

Record Display Schedule Remind
Move View Pre Day Next Day Select

Schedule List			
	08:35	07. Dec	Schedule List
Time	Date	Programme Title	Channel Name

Press the RED button to switch to PVR mode. You can choose the time of the appointment to record you want.

Press the GREEN button to display the detail information about the program

Press the YELLOW button to set the Schedule list information.

Press the BLUE button to Remind setting.

When the time appointment is conflict, it will produce a warning message.

Tips for DTV

1. PVR (Optional)

Press red dot (MEDIA2) button on the remote control to record the current DTV program.

While recording, press PLAY button to start time shift.

Press STOP button to stop recording, then it will return to normal broadcast television.

Press INDEX button to see the information of the recorded list

Press DISPLAY button to see the detail of the program.

When the storage space of Disk is shortage. It will produce a warning message, then it stops recording automatically and return to normal broadcast television.

2. TIME SHIFT

Press PROG button on the remote control to start time shift.

3. Recorded List

In DTV model Press **D.SETUP** button to select Schedule List, then press ENTER button to enter sub-menu. It is available under DTV source.



4.Channel List

Press ENTER button on the remote control on the current DTV program.

Press short key YELLOW button to Select list Mode, Press ▼/▲ button to select DTV, Radio, Data, ATV.



MEDIA OPERATION

Note: Before operating Media menu, Plug in USB device, then Press SOURCE button to set the Input source to Media.

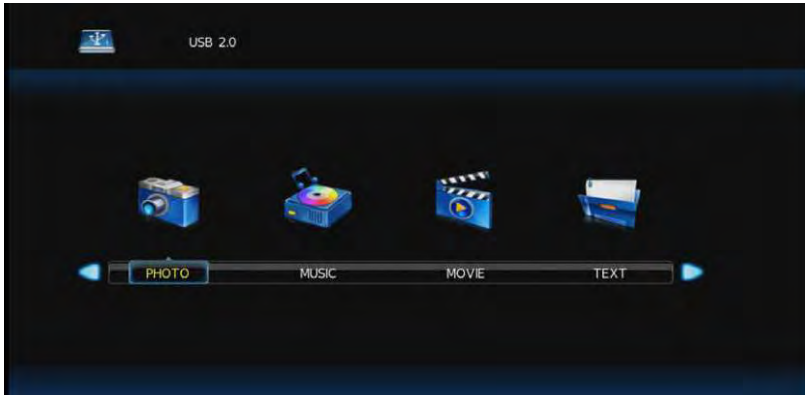

❖ Photo Menu

Press ◀/▶ button to select PHOTO in the menu, then press ENTER button to enter. Press menu button to return back to the previous menu and exit menu to quit.

Press ◀/▶ button to select drive disk you want to watch, then press ENTER to enter. Press ◀/▶ button to select return option to back to the previous menu.

Press ◀/▶ button to select the file you want to watch in the selecting menu, then press media button to display picture.

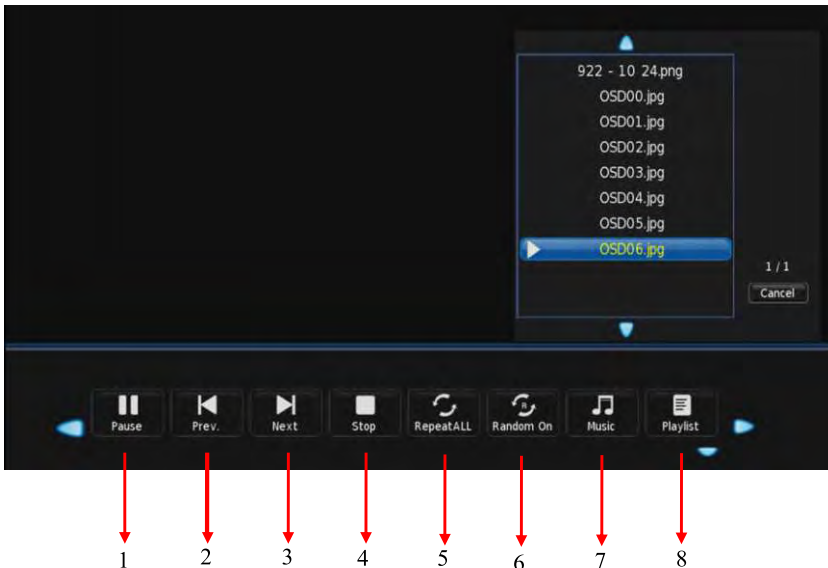

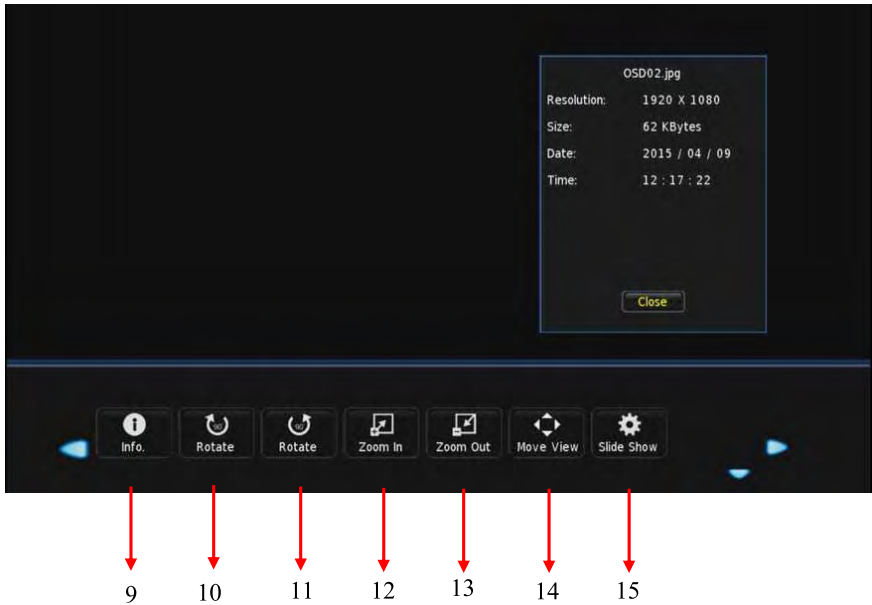

Pick the image of picture with left and right keys. Then click “C port” and open concrete photo. Press ENTER button and there will appear image for further operation

- IMAGE1 pause or display picture
- IMAGE2 show previous picture
- IMAGE3 show the next picture
- IMAGE4 stop/ play
- IMAGE5 single play or circulation
- IMAGE6 random play
- IMAGE7 background music
- IMAGE8 play list
- IMAGE9 Picture information including resolution, size, date, time
- IMAGE10 clockwise rotation
- IMAGE11 counter-clockwise rotation
- IMAGE12 Zoom in to picture
- IMAGE13 Zoom out to picture
- IMAGE14 move view
- IMAGE15 Slide show

❖ Music Menu

Press ◀/▶ button to select MUSIC in the menu, then press ENTER button to enter. Press menu button to return back to the previous menu and exit menu to quit.

Press ◀/▶ button to select drive disk you want to watch, then press ENTER key to enter. Press ◀/▶ button to select return option to back to the previous menu.

Press ◀/▶ button to select a music you want to listen in the selecting menu, then press Enter button to play.

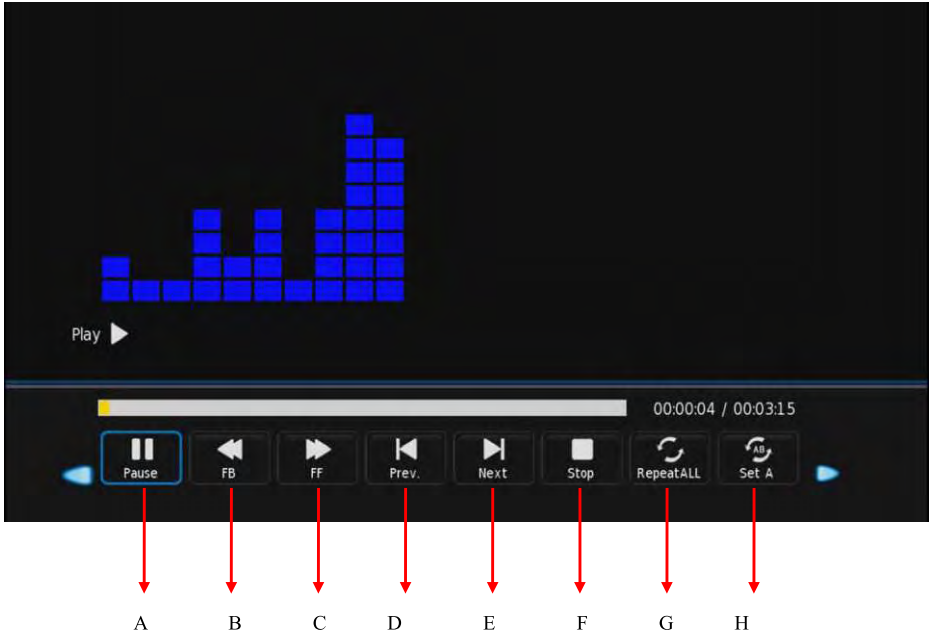

Pick the image of music with left and right keys. Then click “C port” and open concrete song. Press ENTER button and there will appear image for further operation

IMAGE A pause or display music

IMAGE B Fast backward

IMAGE C Fast forward

IMAGE D show previous music

IMAGE E show the next picture

IMAGE F stop play

IMAGE G single play or circulation

IMAGE H set it as A or B

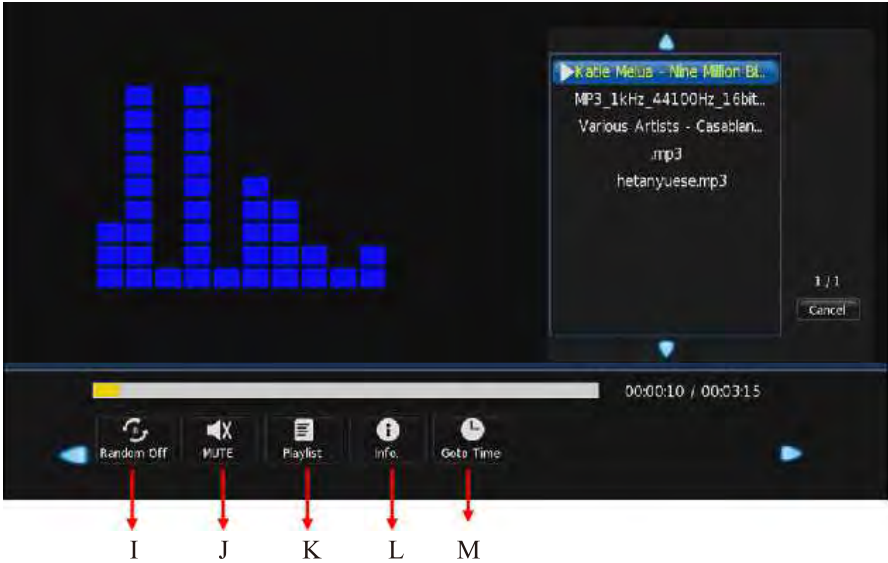

IMAGE I: random play

IMAGE J: Mute

IMAGE K: play list)

IMAGE L: song information

IMAGE M: Goto time for setting searching time

❖ **MOVIE Menu**

Press ◀▶ button to select MOVIE in the menu, then press ENTER button to enter. Press menu button to return back to the previous menu and exit menu to quit.

Press ◀▶ button to select drive disk you want to watch, then press ENTER key to enter operation.

Press ◀▶ button to select a movie you want in the file selecting menu, then press Enter button to play..

Press media button to back to the previous menu and exit button to quit the entire menu.

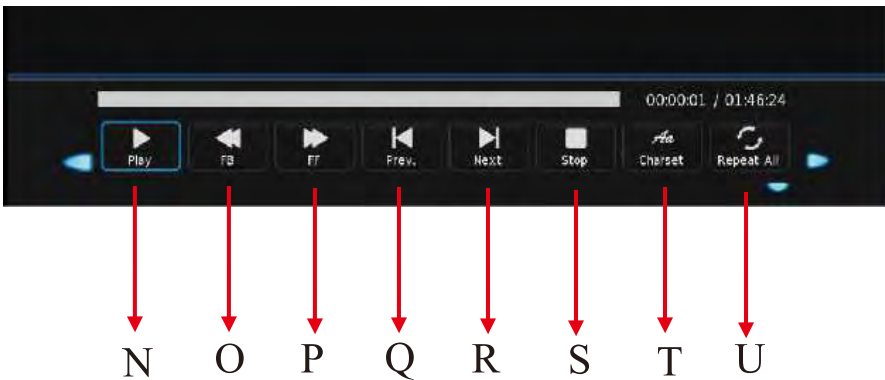

Pick the image of movie with left and right keys. Then click “C port” and open concrete movie. Press ENTER button and you can do operation as following:

- IMAGE N Play or pause media
- IMAGE O Fast backward
- IMAGE P Fast forward
- IMAGE Q Play previous
- IMAGE R Play next
- IMAGE S stop play
- IMAGE T chart list
- IMAGE U repeat mode select

❖ Text Menu

Press ◀/▶ button to select TEXT in the menu, then press Enter button to enter. Press menu button to return back to the previous menu and exit menu to quit.

Press ◀/▶ button to select drive disk you want to watch, then press ENTER key to enter operation..

Press ◀/▶ button to select a text you want in the file selecting menu, then press ENTER button to play..

Press media button to back to the previous menu and exit button to quit the entire menu.

Pick the image of text with left and right keys. Then click “C port” and open concrete text.

Press Enter button and there will appear image for further operation



IMAGE A1 play previous page
IMAGE A2 play next page
IMAGE A3 Play previous text
IMAGE A4 Play next text
IMAGE A5 stop play
IMAGE A6 background music
IMAGE A7 text list
IMAGE A8 text information

Tips for Media Player

1. When highlight the file you select, the file information will appear and Photo/Movie will be previewed.
2. Press Display or ENTER button to pop-out Media Menu, then press ◀/▶ button to select and press Enter button to operate.



DVD BASIC OPERATION

Basic operation

1. Turn ON and OFF the DVD function

- Turn on the LCD TV and then press **SOURCE** repeatedly to select DVD mode.

2. Insert Disc to DVD

- Insert the Disc to the Disc slot (printed side of the disc has to face towards front of the unit), the player will load the disc automatically. There will have an on screen indication "CLOSE" then "READ". After loading the disc content, it will switch to play mode automatically. If the disc is already placed inside, the disc will be read automatically.

NOTE: - For some discs, after loading the content of the disc, need to press **▶** or select from the disc menu to start.

- Please make sure when inserting the Disc, the printed side of the disc should be facing you. When inserting the Disc incorrectly, you may damage the DVD mechanism.

3. Play the DVD

- According to the disc content, the disc menu will display for your selection. When playing the disc, you may use **▶** button to toggle between Play and Pause mode. This product also supports Menu, Title, Sequential and Program playback.

4. Take the disc out

In order to protect the disc, press **■** button then press EJECT button to take the disc out. When the disc is ejected, hold the disc edge slightly and take it from the eject direction to prevent scratches.

- When not using the DVD function (in stand-by mode or using others modes for a long time), please take out the disc to protect the DVD loader and the disc.

Supporting DVD format

This products can play the following format of DVD disc.

Disc Type	Disc Size (Diameter)	Recorded Time	Recorded Content	Remarks
DVD	12cm	Single side:120mins. Approx	DVD format: Compressed digital audio and video	
		Double side:240mins. Approx		
Super VCD	12cm	45mins. Approx	MPEG2 Compressed digital audio and video	Include SVCD
VCD	12cm	74mins. Approx	MPEG1 Compressed digital audio and video	Include: VCD2.0/ VCD1.1 VCD1.0/ DVCD
CD	12cm	74mins. Approx	CD-DA: Digital audio	
HD-CD	12cm	74mins. Approx	HD-DA: Digital audio	
MP3/JPEG	12cm	600mins. Approx	Digital audio	

NOTE: Also support DVD-R, CD-R, CD-RW playback.



WARNING! DO NOT INSERT OR PLAY 8CM DISC, THEY WILL GET STUCK.

DVD REMOTE CONTROL OPERATION

REMOTE CONTROLLER



- To open the disc tray, press OPEN/CLOSE.
- To close the disc tray, press OPEN/CLOSE again.



- Press PLAY/PAUSE from stop mode to start play.
- Press PLAY/PAUSE during playback to pause playback.
- Press PLAY/PAUSE to resume normal playback.



- Press STOP once during playback to stop and hold playback.
- Press PLAY to resume playback from the point you pressed STOP.
- Press STOP twice to stop playback completely.



- During DVD or CD playback, press and hold **▶▶** to scan forward. The player will review the disc at 2, 4, 8 and 16 times normal speed as follows:



Press PLAY to resume normal playback.



- During DVD or CD playback, press and hold **◀◀** to scan in reverse. The player will review the disc at 2, 4, 8 and 16 times normal speed as follows:



Press PLAY to resume normal playback.



- Press PREV to skip to previous chapter or track.



- Press NEXT to skip to the next chapter or track.

0-9



- These keys are used to input the time, as well as title, chapter and track numbers.
- When a numeric item is displayed on the screen, press the 0-9+ keys to select the desired entry, and press ENTER to confirm.

GOTO



- This function allows you to play your favorite Title / Chapter / track. Press GOTO button to activate the on screen scroll-down menu for edit. According to the highlighted area, input your favorite Title / chapter / Track number by numeric buttons or input the playback time. After editing, press **ENTER** to start. If the input is invalid, it will not function.

NOTE: While editing, the **GOTO** button is not function.

SLOW



- While playing the disc, you may use slow motion function.
 - There are 6 speeds for slow motion. Press **▶** button to toggle between different speeds in sequent. (SF1/2, 1/4, 1/8, 1/16, 1/32).
 - While in slow motion, you may press **⏏** to resume normal speed.

💡 **NOTE:** During Slow motion, the sound will be off.

DVD REMOTE CONTROL OPERATION

REMOTE CONTROLLER

REPEAT



- Press REPEAT to select Repeat Title, Repeat chapter, Repeat off during DVD playback.
- Press REPEAT to select Repeat Single, Repeat all and Repeat off (CD or Other).
- During playback, press A-B to select point A.

A-B



- Press it again to select point B. The player will repeat the section from A to B automatically.
- Press A-B third time to cancel A-B repeat and clear points A and B.

💡 Note: 1. During CD playback, points A and B must be within the same track.
 During DVD playback, points A and B can be selected from different chapters.
 2. This function is subject to the disc.

VOL+ VOL-

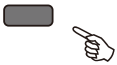

- Press Volume < VOL+ > button to increase Volume.
- Press < VOL- > button to reduce Volume till to no volume output.

MUTE



- Press MUTE to mute the Audio output.
- Press MUTE again to resume normal Audio output.

ZOOM



- During DVD playback, press ZOOM to magnify the image as follows:

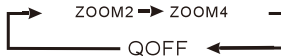

DISPLAY



- Press **DISPLAY** button to activate the on screen roll-down menu for the current Title, Chapter, time and other information
- Press **DISPLAY** button again to turn off the on screen display.

- For DVD discs, (2 pages) Press **DISPLAY** button once to display first page as shown below:

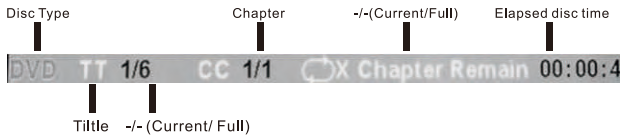

- Press **DISPLAY** button again to display second pages shown below:



- For Super VCD discs, (2 pages), Press **DISPLAY** button once to display first page: Disc type, Track --(Current / Full), Mute status, PBC status, Repeat mode status, Current track time. Press **DISPLAY** button again to display second page: Audio/--(Current/Full) or OFF, Audio type, Language, Subtitle/--(Current/Full) or OFF. Press **DISPLAY** button again to turn off the on screen display.
- For CD, CD-G, HD-CD, MP3 / JPEG discs, Press **DISPLAY** button once to display first page: Disc type, Track --(Current / Full), Mute status, Repeat mode status, Current track time.

DVD REMOTE CONTROL OPERATION

REMOTE CONTROLLER

PROG



● Press PROG to display the [Program] submenu:



DVD/ MP3/JPEG discs

PROG			
T	C	T	C
1	---	5	---
2	---	6	---
3	---	7	---
4	---	8	---
9	---	10	---
13	---	14	---
15	---	16	---

PLAY CLEAR

Super VCD/ VCD/ CD /CD-G/ D-CD discs

PROG			
T	C	T	C
1	---	5	---
2	---	6	---
3	---	7	---
4	---	8	---
9	---	10	---
13	---	14	---
15	---	16	---

PLAY CLEAR

- If it is in PBC ON status, using program playback will turn to PBC OFF automatically.
- According to the highlight area input the title and chapter number by numeric buttons, press **▶** button to start; or move to the <PLAY> by navigation buttons, press **ENTER** button to start.
- While playing the program, you may press **PROGRAM** button to display the program menu for edit. To clear the program by moving to <CLEAR> and press **ENTER** button. Or press **■** button to end the program. When press **▶** button again, the disc will play by sequent.
- While playing the program, there will have an on screen indication "PRG PLAY" and the current title and chapter number.

D.TITLE



● During DVD playback, press D.TITLE to display the DVD title menu or play the first title.

💡 Note: This function is subject to the disc.

D.MENU



● During DVD playback, press D.MENU to return to the program menu.

💡 Note: This function is subject to the disc.

D.SETUP



● Press D.SETUP button to activate the DVD OSD menu.

● For further details, refer to the DVD SETUP.

S.TITLE



● Press S.TITLE button to enable/disable the subtitle.

AUDIO



● Press AUDIO button to change audio's language.

DVD SETUP

SYSTEM SETUP

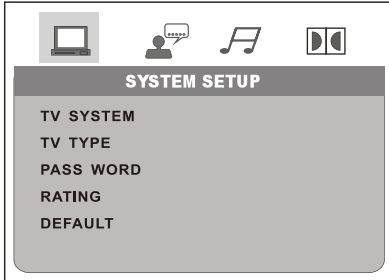

- Press **DVD SETUP** button to activate the DVD player OSD menu;
- Press **◀/▶** button to move and highlight between different sub-menu. Press **◀/▶ ENTER** button to enter the highlighted sub-menu;
- Press **DVD SETUP** button to exit the OSD menu.

NOTE: In Setup mode, the following functions will be cancel or pause :
TITLE, SUB-TITLE, DISPLAY, PLAY, SETUP, STOP, SLOW / STEP, NICAM / AUDIO, FF, FR, PREV,
NEXT, GOTO, ZOOM, ANGLE, PROGRAM, PREVIEW, REPEAT, REPEAT A-B.

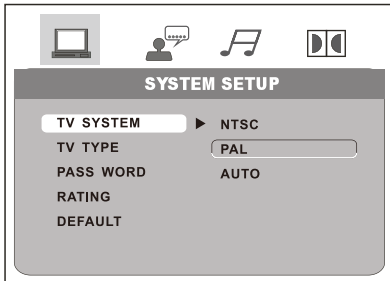

NOTE:
PAL format is generally used for TVs in the UK. Check your TV user guide for supported formats. If NTSC is selected with a non-compatible television you may experience interference or picture scrolling.

DVD SETUP

TV Type

DVDs are produced in a variety of screen aspect ratios. This menu enables you to select one of the three aspect ratios:

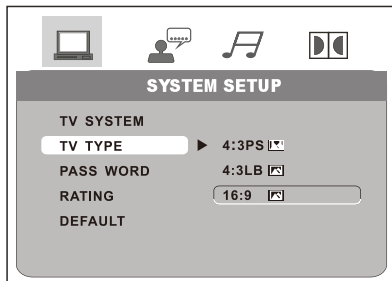

- 4:3 PS (Normal)

- 4:3 LB (Normal)

- 16:9 (Wide)

- Select the most appropriate aspect ratio for the DVD being viewed.

4:3PS (Normal)

Normal Pan and Scan is used for most normal television broadcasts and it is the default setting. It has an aspect ration of 4:3. If you select this setting when viewing a DVD the picture will fill the screen but, you will not see the left and right edges of the picture.



4:3LB (Normal)

Normal Letter Box will show the DVD in its original aspect ratio so depending on the size of your television screen, you may see black borders above and below the picture.

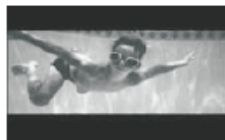

16:9 (Wide)

Choose this setting if you have a widescreen television.



💡 NOTE:

- Playback screen size may vary according to the discs contents.
- For discs with 4:3 contents, using any mode would only display a 4:3 screen
- Screen ratio selection should be according to the connected TV / Display aspect ratio.

DVD SETUP

PassWord

- The default setting is locked. No Rating selection or change password could be done. To edit the Rating setting, please enter default password "0000" by numeric buttons, then press **ENTER** button to confirm.
- To change password, input any 4 digit number when the lock is unlocked. Once the 4 digit number is entered, that will be your new password.

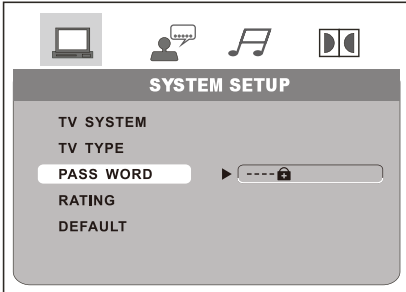

Rating

- Playback for some discs with rating, you can select the rating setting according to your preference. Rating restriction divided in eight different category from KID SAFE to ADULT.

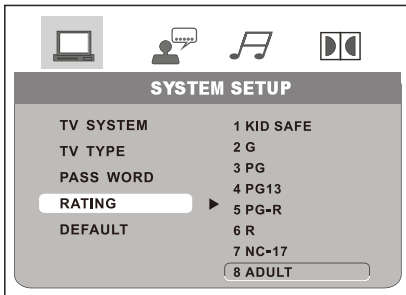

NOTE:

Only editable when password is unlocked. And only can function when password is locked. It does not, however, reset either the Password or the Rating setting.

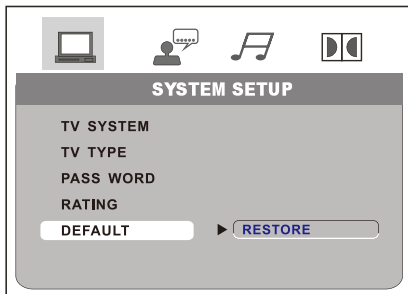

Default Setting

- Press **ENTER** button to restore factory default.

DVD SETUP

Language Setup

Press **DVD SETUP** button to enter the DVD OSD menu.

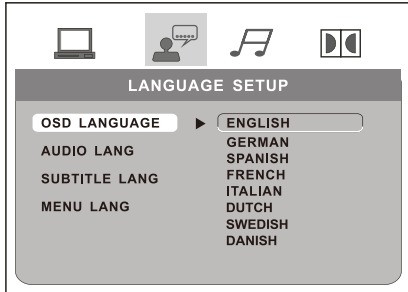

- OSD Language

Use navigation buttons to select the OSD LANGUAGE setup icon, press ENTER button to confirm. There are 6 languages for your selection, press ▲ & ▼ buttons to toggle between different languages. Press ENTER button to confirm.

💡 NOTE:

If the selected language is not included in your DVD disc content, it will select the default language of the disc automatically.

- Audio Language

Use navigation buttons to select the AUDIO LANG setup icon, press ENTER button to confirm. There are 6 languages for you selection, press ▲ & ▼ buttons to toggle between different languages. Press ENTER button to confirm.

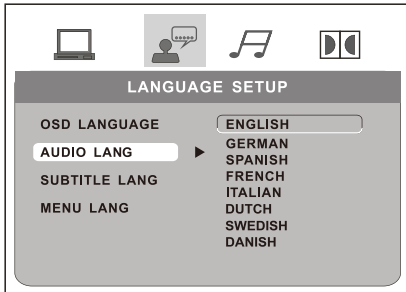

💡 NOTE:

If the selected language is not included in your DVD disc content, it will select the default language of the disc automatically.

- Subtitle Language

Use navigation buttons to select the SUBTITLE LANG setup icon, press ENTER button to confirm. There are 6 languages for you selection, press ▲ & ▼ buttons to toggle between different languages. Press ENTER button to confirm.

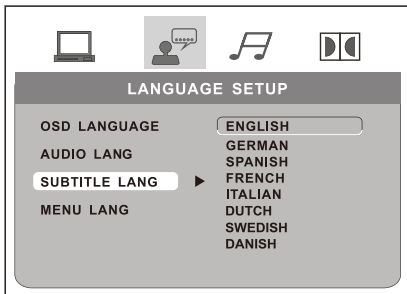

💡 NOTE: If the selected language is not included in your DVD disc content, it will select the default language of the disc automatically.

SPECIAL NOTE: Language Setup needs to be pre-set in DVD SETUP before putting the disc in.

DVD SETUP

LANGUAGE SETUP

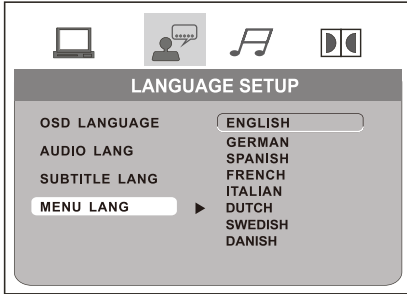

- Use navigation buttons to select the MENU LANG setup icon, press ENTER button to confirm. There are 6 languages for you selection, press ▲ & ▼ buttons to toggle between different languages.
Press ENTER button to confirm.

Audio Setup

Tone

- Use ▲ & ▼ buttons to adjust the Tone setting.

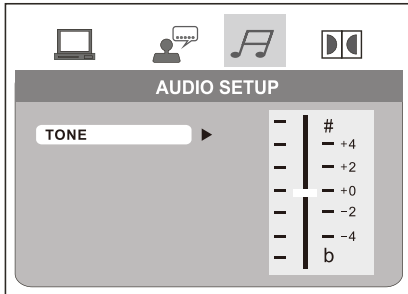

DVD SETUP

DIGITAL SETUP

Dynamic Range

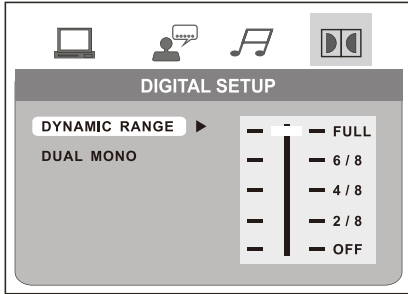

- When switch the compress mode to "Audio output", adjust the compress ratio for different effect. When selected FULL, the peak signal value is smallest. When selected OFF, the peak signal value is highest.

Dual Mono

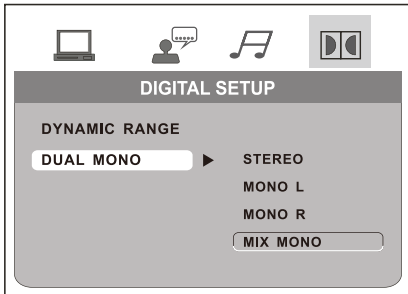

- You can select four different audio output, STEREO, MONO L, MONO R, MIX MONO. The audio out description of these Selections is shown in the table below.

MODE	LEFT SPEAKER	RIGHT SPEAKER
STEREO	STEREO-L	STEREO-R
L-MONO	L-MONO	L-MONO
R-MONO	R-MONO	R-MONO
MIX-MONO	L-MONO+R-MONO	L-MONO+R-MONO

SUPPORTED OPERATING MODES

VGA INPUT

Mode	Resolution	Horizontal Frequency (KHz)	Vertical Frequency (Hz)
DOS	720X400	31.5	70
VGA	640X480	31.50/37.90/37.50	60/72/75
SVGA	800X600	37.90/48.10/46.90	60/72/75
XGA	1024X768	48.40/56.50/60	60/70/75
SXGA	1280X1024	64.0	60
SXGA	1360X768	47.7	60
WXGA+	1440X900	59.9	60
WUXGA	1920X1080	67.50	60

* Depend on panel resolution.

HDMI INPUT

Mode	Resolution	Horizontal Frequency (KHz)	Vertical Frequency (Hz)
480i/60	720X480	15.75	30.00
576i/50	720X576	15.63	25.00
480P/60	640X480	31.50	60.00
576P/50	720X576	31.25	50.00
720P/60	1280X720	45.00	60.00
1080i/50	1920X1080	28.13	50.00
1080i/60	1920X1080	33.75	60.00
1080P/50	1920X1080	56.25	50.00
1080P/60	1920X1080	67.50	60.00

- Modes, which are not listed in the above table, may not be supported. For an optimal picture is recommended to choose a mode listed in the table.
- The incoming display modes compatible with WINDOWS as shown in the table above.
- Sometimes, the image may be disrupted due to the frequency standard from the VGA card. However, this is not an error. You may improve this situation by activating the automatic adjustment or by manually changing the phase and the clock settings in the menu.
- To extend the service life of the product, we recommend that you use your computer's power management function.

TROUBLE SHOOTING

Before contacting the service technician, perform the following simple checks. If any problem still persists, unplug the LCD TV and calling for serving.

Problem	Possible Solution
No sound or picture	<ul style="list-style-type: none"> ● Check that the main plug has been connected to a wall outlet. ● Check that you have pressed the  button on the front of the TV. ● Check the picture contrast and brightness settings. ● Check the volume.
Normal picture but no sound	<ul style="list-style-type: none"> ● Check the volume. ● Check whether then MUTE button has been pressed on the remote control.
Sound is too low	<ul style="list-style-type: none"> ● Check the volume. ● If the volume is still too low after setting the volume level to its maximum, check the volume control on any external device connected.
No picture or black and white picture	<ul style="list-style-type: none"> ● Adjust the colour settings. ● Check that the broadcast system selected is correct.
“Unknown” message	<ul style="list-style-type: none"> ● Make sure that the power cord is firmly connected to the PC or the video sources. ● Make sure that the PC or video sources are switched on.
Sound and picture interference	<ul style="list-style-type: none"> ● Try to identify the electrical appliance that is affecting the set and move it further away.
Blurred or snowy picture, distorted sound	<ul style="list-style-type: none"> ● Check the direction, location and connections of your aerial.
Remote control does not work	<ul style="list-style-type: none"> ● The battery in the remote control may be exhausted. ● The battery may be improperly installed. ● Check that there is no obstruction between the remote control and the remote (infrared) sensor. ● Ensure that there is no strong light shining on the remote control's infrared sensor.
The LCD TV does not turn on	<ul style="list-style-type: none"> ● Be sure the power cord is plugged on.
The image is too light or too dark	<ul style="list-style-type: none"> ● Adjust the brightness and Contrast.
On PC mode, horizontal bars appear to flicker, jitter or shimmer on the image	<ul style="list-style-type: none"> ● Adjust the Phase.
On PC mode, vertical bars appear to flicker, jitter or shimmer on the image	<ul style="list-style-type: none"> ● Adjust the Clock.
In PC mode, image is not stable and may appear to vibrate	<ul style="list-style-type: none"> ● Check that the display resolution and frequency from you PC or video board is a valid mode for your LCD TV. Control Panel→ Display→ Settings. ● If the setting is not correct, use your computer utility program to change the display settings. Your monitor supports multiscan display function within the following frequency domain: Horizontal frequency: 31.5~60KHz Vertical frequency: 60~75Hz Maximum refresh rate: 1920 X 1080@60Hz * Depend on panel resolution.
In PC mode, image is not centred on the screen.	<ul style="list-style-type: none"> ● Adjust the horizontal and vertical position.

SPECIFICATIONS

LED MODEL		GTV22DVD		
LED Panel	Display diagonal	21.5" 16:9		
	Pixel numbers	1920(H) x 1080(V)		
	Color Depth(colors)	16.7M		
	Viewing Angle(H/V)	178° /178°		
ATV System	Tuner receiving range	49MHZ-863MHZ		
	Video System	PAL, SECAM		
	Sound System	BG, DK, I, L/L' NICAM/A2		
	Storage Channels	200CH		
	Teletext	1000 Pages		
DTV System	Tuner receiving range	VHF (49MHZ-863MHZ) UHF (474MHZ-862MHZ)		
	Channel bandwidth	7MHZ/8MHZ		
	Modulation	DVB-C	MODULATION	16QAM, 32QAM, 64QAM, 128QAM, 256QAM
			Video System	MPEG-2MP@ML, MPEG-2MP@HL, H. 264
			Audio System	MPEG-1, MPEG-2(Layer I//II)
			Receive Channel	DTV:500
		DVB-T	MODULATION	COFDM 2K/8K, QPSK, 16QAM, 64QAM
			Video System	MPEG-2MP@ML, H. 264
			Audio System	MPEG-1, MPEG-2(Layer I//II)
			Receive Channel	DTV:500
			Tuner 5V Supply	5V 500mA
		DVB-T2	MODULATION	COFDM:1K TO 32K; T2-Lite, 1/3, 2/5; QPSK:16QAM, 32QAM, 64QAM, 256QAM; Bandwidth:6, 7, 8MHZ; Guard Interval: 1/128--1/4; code rate: 1/2, 3/5, 2/3, 3/4, 4/5, 5/6; SPP:PP 1 to PPS
			Video System	MPEG-2MP@ML, H. 264/H. 265
			Audio System	AC-3, MPEG-1/2 Layer I and II
	DVB-S/2	MODULATION	COFDM 2K/8K, QPSK, 8PSK	
		LNB power	Auto/13V/18V/OFF Output 500mA@MAX	
LNB Switch Control		22kHz		
DiSEqC Version		1.0, 1.1, 1.2, 1.3(USALS) compatible		
Video System		MPEG-2MP@ML, H. 264/H. 265		
Audio System		MPEG-1, MPEG-2(Layer I//II)		
Receive Channel		DVB-S2:4000		

LED MODEL		GTV22DVD	
Video Input	PC-RGB	Up to 1920 x 1080@60HZ	
	Video System	PAL/SECAM/NTSC	
	Video Level	1.0 Vp-p \pm 5%	
	Component	480i, 480p, 576i, 576p, 720p, 1080i, 1080p	
	HDMI	480i, 480p, 576i, 576p, 720p, 1080i, 1080p	
Audio Input	Earphone input	0.2-2.0Vrms	
	L/R RCA	0.2-1.0Vrms	
Speaker Output	Frequency Response	100HZ-15KHZ @ \pm 3dB	
	Output power	2 x 3 (8 Ω)	
Input Terminals	ATV&DTV (DVB-T/T2/C)	X 1 (IEC 75 Ω)	
	DVB-S, S2	X 1 (F-Connector)	
	CVBS&Audio	X 1 (Mini Terminal)	
	HDMI	X 2; HDMI1 With ARC, HDMI2 With MHL	
	YPBPR	X 1 (Mini Terminal)	
	CI Slot (CI+)	X 1	
	PC-RGB	X 1	
	PC-Audio	No	
	USB Slot	X 1 (USB2.0 5V \equiv 500mA)	
	DVD (Optional)	X 1	
Output Terminals	Coaxial	X 1 (RCA Terminal)	
	Earphone	X 1	
	AV OUT	X 1 (Mini Terminal)	
USB Multimedia Function	Picture	Files Ext.	*.JPG, *.JPEG, *.BMP, *.PNG
	Music	Files Ext.	*.MP3, *.WMA, *.M4A, *.AAC
	Movie	Files Ext.	*.AVI, *.MKV, *.MOV, *.MP4, *.VOB, *.MPG, *.TS, *.DAT, *.RM/RMVB
		Video Codec	H.264 MPEG-2 MPEG-4 Xvid
		Audio Codec	MP3 AAC WMA
<p>Important Notice:</p> <p>Please note that media files listed here are examples that we test in factory up to the date of manufacture. As a result of new development there could be new codec files with same extension names, we are not able to ensure that all media files.</p>			
Power Supply	DC-DC	10.8-32.0VDC, DC Terminal 5.5/2.5mm	
	AC Adapter	100V-240V \sim 50/60HZ Input, DC12V 4A Output	
Power Consumption	Max.	30W	
	Standby	\leq 0.5W	

LED MODEL		GTV22DVD
Environmental considerations	operating Temperature	0 ~ 35°C (32°F~95°F)
	operating Humidity	10% ~ 80%
Dimension (WxDxH)mm	Without Stand	534X42X349
	With Stand	534X170X392
Weight (kg)	Net Weight	4.2
	Gross Weight	4.7

NOTE:

*Design and specifications are subject to change without notice.

*Weight and dimensions shown are approximate values only.

STAND INSTALLATION

GTV22DVD

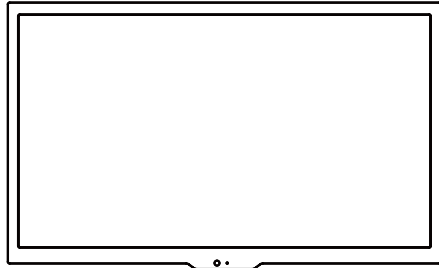

SCREW PT 4X12
2PCS

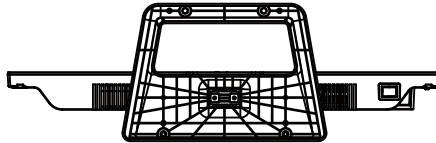

Stable Wall Mount Dimension

Model	Dimension	Screw
GTV22DVD	100X100	M4X10

TECHNICAL ASSISTANCE

If you need assistance setting up or using your Gator product now or in the future, call Gator Support. Australia

TEL: 03 – 8587 8898

FAX: 03 – 8587 8866

Mon-Fri 9am – 5pm AEST

Please retain this user guide for future reference.

If you would like to download a digital copy of this manual, or other Gator manuals/software, please visit the <http://gatordriverassist.com> website and click on ‘Firmware & Manuals’ or search for the product model number for more information, accessories and products.

This manual is considered correct at time of printing but is subject to change. For latest manuals and updates refer to the website.

Copyright © 2017 by TDJ Australia

All rights reserved. No part of this publication may be reproduced, distributed, or transmitted in any form or by any means, including photocopying, recording, copying or other electronic or mechanical methods, without the prior written permission of the author.

This product must be disposed of correctly. Please contact your Local Authority for the appropriate method of disposal.



Revision:1.0

