

GATOR

GHDVR293

HD 1080P
DASH CAM



Manual



Resolution



Screen Size



Wide Angle



Super
Capacitor



G Sensor



Suction
Mount

Introduction

Thank you for purchasing the Gator GHDVR293 Dash Cam. Please ensure that you have read the product manual and instructions in full, prior to installation and use. Failure to do so may result in product failure/damage or incorrect operation and therefore impact the product performance.

Product overview

The Gator GHDVR293 Dash Cam has been designed to provide high definition recordings of your trips for security and evidence in the case of an accident. The Dash Cam simply mounts to the windscreen and records footage onto a Micro SD memory card. It has a G-sensor with adjustable sensitivity and loop recording functionality.

Product features

- ❑ HD 1920 x 1080P @ 24FPS
- ❑ 2.3" 4:3 High-resolution LCD screen
- ❑ 110 Degree HD wide angle lens
- ❑ Super capacitor works in extreme temperature & saves last recording once power is disconnected
- ❑ Suction car mount with 360 degree rotation
- ❑ Seamless cycle loop recording
- ❑ G-Sensor function
- ❑ 12V in-car USB charger
- ❑ 4GB Micro SD card included
- ❑ Supports Micro SD card class10 up to 32GB
- ❑ Mini USB interface

Table of Contents

Introduction	2
Product overview	2
Product features	2
Table of contents	3
Package components.....	4
Product structure	5
Installation of Dash Cam	6
Fixing the Dash Cam	7
Indicator lights.....	7
Powering your Dash Cam	7
Video and photo operation	8
Video/Photo playback	9
Dash Cam menu	10
Video menu settings.....	10
Tools menu settings.....	11
Photo menu settings.....	12
Resetting Dash Cam	13
Formatting the SD card.....	13
Locking footage	13
Connecting to a PC	13
Product specifications	14
Trouble shooting guide	15
Technical assistance	16

Package components



GHDVR293



Mounting
Bracket



USB to Mini USB



Car Charger



4G Micro SD
Card



GHDVR293
User Manual

Product structure

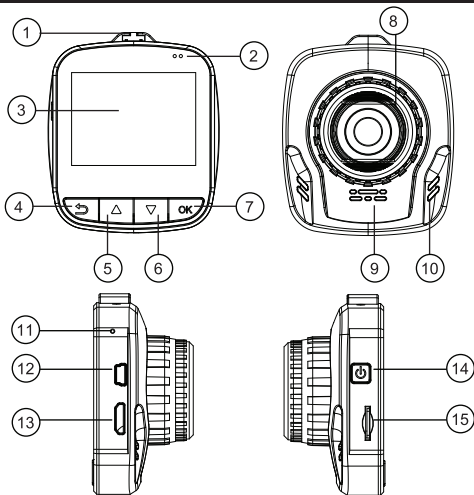

- 1) Mounting Slot
- 2) Power Indicators
- 3) LCD Screen
- 4) Menu/Return
- 5) Up
- 6) Down
- 7) OK Button

- 8) Lens
- 9) Mic
- 10) Speaker
- 11) Reset
- 12) Mini USB port
- 13) HDMI port (not supported)
- 14) Power/Lock Button
- 15) Micro SD Card Slot

Installation of Dash Cam

1. Ensure windscreen is clean and free of debris. Attach suction cup to the windscreen and lock into position with the lever.
2. Fix where the vision is not blocked (Place close to rear-view mirror is recommended). Don't install device on airbag or within its working range.
3. Insert Micro SD card into the Dash Cam
4. Insert Mini USB end of the 12V power adapter into the Mini USB interface/ charging point of the Dash Cam. Connect socket end of the adapter into the into 12V power socket of vehicle.
5. Adjust the mounting bracket and rotate the camera direction to get the best view. Ensure $\frac{1}{4}$ of the vehicles bonnet is visible from the bottom of the screen for alignment.
6. Turn vehicles ignition to accessories, and the Dash Cam will power ON and start recording automatically, you will hear an audible tone once powered.
7. The power indicator LED will show red and blue whilst the Dash Cam is receiving power.
8. A red circle on screen will start flashing when recording has started.
9. For the Dash Cam to work it must receive power from the charging adapter. Once power is removed or turned off the Dash Cam will save the current file and turn off.

ATTENTION:

The Dash Cam must be connected to power when in use. The super capacitor only holds date and time settings. The Dash Cam has no internal battery.

Fixing the Dash Cam

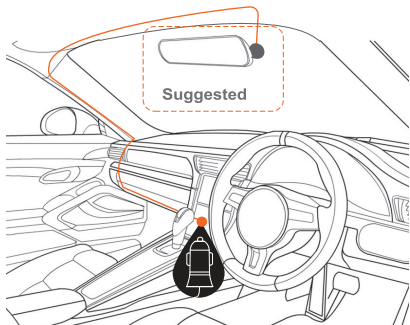

Indicator lights

1. The power indicator LED lights up red and blue. The charge symbol on screen flashes when the Dash Cam is receiving power.
2. When the red circle flashes on the screen the Dash Cam is recording.

Powering your Dash Cam

Press the power button to turn the Dash Cam on. It will automatically start recording once it receives power. When power is turned off manually or power is removed, the Dash Cam will save the current file and turn off.

Video and photo operation

Video Mode

There is a camera icon at the top left corner of the LCD to signify you are on video mode. When the Dash Cam is recording, a red circle indicator appears and flashes on the top left corner of the screen. To stop the recording, simply press the OK button. Press OK button again to resume recording. Pressing the return button in video mode will allow you to adjust the video resolution, image quality and other video settings.



Photo Mode

Press the power button to switch the Dash Cam to photo mode. There is a camera icon at the top left corner of the LCD to signify you are on photo mode. To take a photo, press the OK button. The screen will flash and make a camera sound when a picture is taken. Pressing the return button in photo mode will allow you to adjust the photo resolution, image quality and other photo settings.



Video/Photo playback

Press the power button until you see the video reel icon on the top left of the screen representing playback mode. Using the arrow buttons, you can choose between all your recorded videos or photos. The protected files have a lock icon meaning they cannot be deleted until unlocked. Press the OK button to select a file for playback. Pressing the return button once will give the option to delete, protect or unlock the file. Pressing the return button twice will open video settings. Press OK button to initiate changes. Press the return button again to return to video mode.

Video Playback Screen

Video reel icon ———

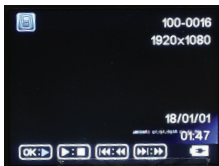
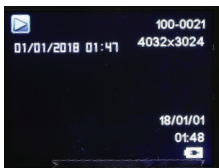

Photo Playback Screen

Photo icon ———



DASH CAM Menu

Menu Settings

Press the Menu (Return) button to get into the menu settings when not recording. Press once for Video settings, twice for Tool settings. You can navigate the settings menu by using the Up/Down buttons. To change or edit a selected setting, press the OK button. Press the menu button again to exit the menu settings.

Video Menu Settings

Resolution:

Resolutions available are 1080 HD 1920x1080 or 720P 1280 x 720. The recommended resolution should be set at '1080 HD 1920x1080 in order to get the best quality footage.

Loop Recording:

This feature allows you to set the size of the files your Dash Cam will record before saving and creating a new file. It allows the Dash Cam to record over the oldest recorded files once the card is full. This can be turned OFF, or record 1,3 & 5 minute video files. If you want to keep any of the files it is best to upload them to your computer. We recommend the Dash Cam to be set to '3' minute files

Exposure:

This feature will change the light and dark balance of your photos. We recommend it always be set at '0'.

Record Audio:

This Feature will allow you to turn the Dash Cam's recording sound on or off. If you want to stop the Dash Cam recording sound in the cab of your vehicle, set this feature to 'off'.

WDR:

Wide Dynamic Range is used to achieve greater exposure to dynamic range than normal digital image technology and make video and pictures look better.

Date Stamp:

This feature will stamp the date and time on all your footage produced by your Dash Cam.

G Sensor:

This feature allows you to set the sensitivity of the Gravity sensor in the Dash Cam. Settings are OFF, Low, Medium & High. We recommend this be set to 'LOW' to help stop false or irrelevant readings.

Tools Menu Settings

Date/Time:

This feature will allow you to change the year, month, day and time. To change the date simply use the arrow keys to go up or down. Press the OK button to move onto the next section. Again, use the arrow buttons to go up or down. Once through all the sections, pressing return button will finish the setup.

Beep Sound:

Allows you to turn the beeping sound on or off.

Language:

Allows you to choose from a selection of languages that include: English, French, Spanish, Portuguese, Dutch, Italian, Chinese & etc

Frequency:

This feature allows the best recording in conditions where street lights and ac lighting is used. The Australian standard frequency is 50HZ so it should be set to '50hz'.

Screen savers:

This feature will turn your LCD off after 30 seconds, 1 or 2 minutes but will continue to record regardless. This feature is useful for night driving as having the LCD on could be a distraction.

Carplate:

Allows you to enter your vehicle number plate to show on recorded video.

Format:

This feature allows you to format/delete all the files off your micro SD card and also reinstalls your DCIM directory and Dash Cam software on your SD card so the micro SD card can operate with your Dash Cam free of errors.

Default Setting:

This feature will reset all your settings and return your Dash Cam to the factory standard settings.

Version:

This simply shows the firmware/software used by the Dash Cam's hardware.

Photo Menu Settings

Menu Settings

Press the Menu (Return) button to get into the photo menu settings when not recording. Press once for Photo settings, twice for Tool settings. You can navigate the settings menu by using the Up/Down buttons. To change or edit a selected setting, press the OK button. Press the menu button again to exit the menu settings.

Capture Mode:

Change from different shooting modes. Single, 2, 5 and 10 second timer.

Resolution:

Resolutions available are 12M, 10M, 8M, 5M, 3M, 2M, 1.3M & VGA

Sequence:

This feature will change allow you to take multiple photos with one click

Quality:

Fine, Normal & Economy

Sharpness:

Strong, Normal & Soft

White Balance:

Auto, Daylight, Cloudy, Tungsten & Fluorescent

Color:

Color, Black & White or Sepia

ISO:

Auto, 100, 200 & 400

Exposure:

This feature will change the light and dark balance of your photos. We recommend it always be set at '0'.

Photo Menu Settings Cont....

Anti-Shaking:

To help with motion blur when taking photos

Quick Review:

Used for viewing images as a slideshow

Date Stamp:

Used for displaying date and time on photos taken

Resetting DASH CAM

To hard reset the device in the case of a system jam or crash. Insert a fine point paper clip into reset hole on the side of the Dash Cam above the USB input

Formatting the SD Card

It is advisable to format the card weekly. As all footage that is locked will fill up the card causing it to stop recording any footage

Locking Footage (SOS)

When recording press the power button. A lock key will appear on the screen and this will save any footage from getting erased from the card. Press again to unlock when recording. To remove locked footage you must unlock the file on the Dash Cam or format the card on the device or your computer.

Connecting to a PC

When connecting your Dash Cam to a PC with the USB cable, the Dash Cam will present "Mass Storage" on its screen allowing you to transfer your videos and photos to your PC. Press OK button and a "SD Card" icon will appear on your PC with a folder DCIM inside. Video and picture files will be in this folder.

Product specifications

CPU	NTK96223
Display	2.31-inch LCD screen
Color	Black
Video	AVI
	1080 HD 1920x1080 at 24fps
	720P HD 1280 x 720 at 30fps
Picture	12M, 10M, 8M, 5M, 3M, 2M, 1.3M & VGA
Picture format	JPG
Viewing Angle	110 degree view angle
Functions	G-Sensor, Loop recording
OSD Language	English, Russian, Chinese, etc
Audio	Built-in Microphone and speaker
Storage	Micro SD card (4GB included) Up to 32GB Class 10 Max
Input / Output	Mini USB
Battery	Super Capacitor
Dimension	7.5*6.0*3.8CM(H*W*D)
Accessories	Car mount, Car charger, USB cable

Troubleshooting guide

Under normal operating conditions, if there are problems with the device, please refer to the following methods to resolve.

Cannot take pictures or record video?

Please check whether there is enough space on the micro SD card or internal storage.



Stopping automatically while recording?

Due to the high amount of HD video data being recorded, please use a high-speed Micro SD card. To tell if you have the required high speed card, check if it has the 'Micro SDHC' logo on the SD card and 4GB class 10 or above is recommended. Make sure that your card is labeled Micro SDHC and not Micro SDXC as SDXC cards will not work with this Dash Cam.

Fuzzy/dirty image?

Please check if the lens is filled with dirt or fingerprints and clean carefully. Please clean lens with cloth before shooting. Remove transparent lens protector.

The DASH CAM is jammed or not responding?

Please hard reset the device by pushing in the reset button on the Dash Cam.

Why is the DASH CAM not turning on in the car?

Please check and make sure that there is power in the cigarette lighter socket of your car.

Micro SD card not recognised by DASH CAM?

Format card in the Dash Cam's menu setting's before use.

A coloured tinge showing up in the video?

Make sure to peel off the transparent protective sticker on the front of the Dash Cam's lens.

Technical assistance

If you need assistance setting up or using your Gator product now or in the future, call Gator Support.

Australia

TEL: 03 – 8587 8898

FAX: 03 – 8587 8866

Mon-Fri 9am – 5pm AEST



Please retain this user guide for future reference.

If you would like to download a digital copy of this manual, or other Gator manuals/software, please visit the <http://gatordriverassist.com> website and click on 'Firmware & Manuals' for information on where to find the manuals/software.

This manual is considered correct at time of printing but is subject to change. For latest manuals and updates refer to the website.

Copyright © 2017 by TDJ Australia

All rights reserved. No part of this publication may be reproduced, distributed, or transmitted in any form or by any means, including photocopying, recording, copying or other electronic or mechanical methods, without the prior written permission of the author.