

clarion®

Owner's manual

VX603AU

**DVD MULTIMEDIA STATION WITH BUILT-IN
BLUETOOTH & 6.2" TOUCH PANEL CONTROL
NAVIGATION READY (SD603AU SOLD SEPARATELY)**

NOTICES / WARNINGS

Navigation: (SD603AU sold separately)

Your VX603AU is navigation ready. If you did not include navigation in your original purchase, you can very easily add navigation to your unit at any stage by purchasing the Clarion SD603AU. Installation is as simple as inserting the MicroSD card.

The SD603AU comes with full 3D map coverage of Australia & New Zealand and includes features such as: Turn-by-turn voice guidance with Text-to-Speech, Motorway Junction View, Tunnel View, SUNA Predictive Traffic, 3D City & 3D landmarks, Extended Points of Interest, School Zones, Speed Camera and much more.

To ensure you are not purchasing a product where the map is out of date, the SD603AU comes with a "Latest Map Guarantee". This means that no matter when you decide to purchase the SD603AU, you have a full 30 days to download the latest map via Clarion's dedicated update site, "clarion.naviextras.com".

GPS Antenna:

Although the navigation MicroSD (SD603AU) is sold separately, it is important to know that the GPS antenna is supplied with your VX603AU.

Clarion strongly recommends that the GPS antenna be installed at the same time as your unit. This will save time and possibly additional installation cost in the future because your unit will have to be removed from the dashboard.

Reverse Camera Warning:

For your safety, the driver should not watch any video sources and/or operate the controls while driving. This includes the use of reversing cameras while travelling in a forward direction which is prohibited, according to Australian Road Laws.

Clarion strongly recommends that when installing a reverse camera to this product, the camera's power source be derived from the vehicles reversing lamp circuit either directly (if suitable) or via the use of a relay. This will ensure that the reverse camera can only be viewed while the vehicle is travelling in a reverse direction.

Legal Safety Requirement:

According to Australian law, it is illegal for a driver to view a video source while the vehicle is in motion. It is a legal requirement that the park brake wire of this unit be connected to the vehicle park brake terminal.

Clarion Co. Ltd., Clarion Australia Pty. Ltd. will not be held responsible for improper installation of this product which infringes any law.

Warranty Conditions:

For detailed information regarding warranty conditions please see the separate warranty card enclosed with your product. There you will also find information regarding how to register your product for Clarion's "Free Extended Warranty" program.

- "*Free Extended Warranty*" subject to terms and conditions

You can also view the warranty conditions at any time by visiting the Clarion website and clicking on the "Warranty Information" link.

<http://www.clarion.com.au>

Contents

Thank you for purchasing this **Clarion** product.

- Please fully read this owner's manual before operating this equipment.
- Check the contents of the enclosed warranty card and store it in a safe place with this manual.

1. FEATURES	4
Expanding Systems	4
2. PRECAUTIONS	5
3. CAUTIONS ON HANDLING	6
Front Panel / Generalities	6
Cleaning the body	6
USB Port	6
SD Slot	6
Handling Discs	7
4. CONTROLS	8
Operational Panel	8
Names of Buttons	8
Remote Control	9
5. MAIN MENU OPERATIONS	11
6. SYSTEM SETUP	12
7. DISC OPERATIONS	15
DVD System	15
Accessing a Disc	17
DVD Player Operations	18
CD Player Operations	20
MP3/WMA Playback	21
MP4/DivX Playback	23
8. SD/USB OPERATIONS	24
Accessing an USB	24
Accessing an SD Card	24
SD/USB Audio Operations	25
SD/USB Video Operations	25
9. BLUETOOTH OPERATIONS	26
Bluetooth Telephone Operations	26
Bluetooth Audio Operations	28
10. RADIO OPERATIONS	29
11. PANDORA OPERATIONS	31
12. iPod & iPhone OPERATIONS	32
13. NAVIGATION OPERATIONS (Sold separately)	34
14. AUX OPERATIONS	34
15. TROUBLE SHOOTING	35
16. ERROR DISPLAYS	38
17. SPECIFICATIONS	39
18. WIRING AND CONNECTIONS	40

1. FEATURES

- 6.2" Wide-VGA colour LCD TOUCH PANEL
- Compatible with iPod® / iPhone® via USB
- 4V/6ch RCA Output with HPF/LPF and BEAT-EQ with 3 Band Parametric Equalizer
- Optional Navigation with "Latest Map Guarantee" (Navigation sold separately)

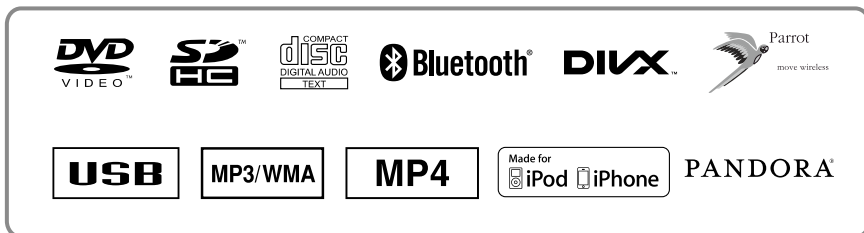

Expanding Systems

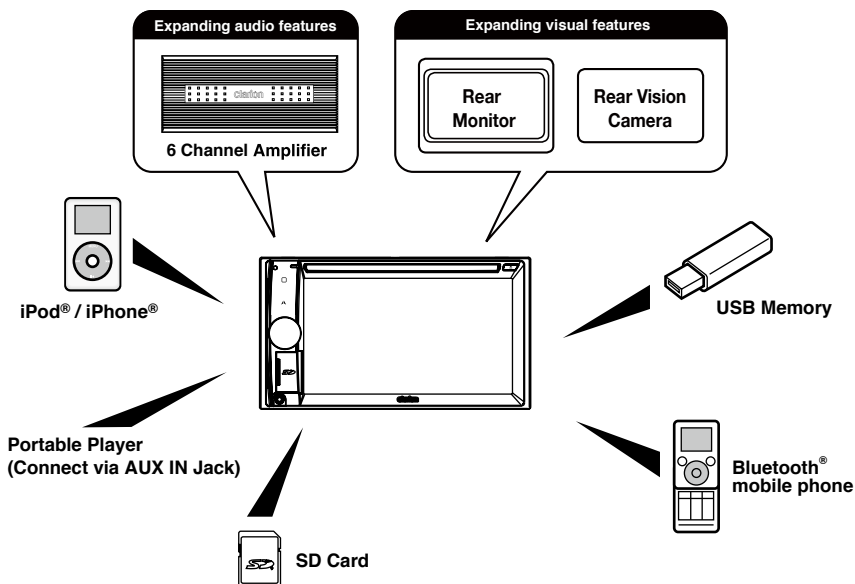

Notes:

- The items listed outside of the frames are the commercial products generally sold.

2. PRECAUTIONS

WARNING

For your safety, the driver should not operate the controls while driving. Also, while driving, keep the volume to a level at which external sounds can be heard.

1. When the interior of the car is extremely cold and the player is used soon after switching on the heater, moisture may form on the disc or the optical parts of the player and proper playback may not be possible. If moisture forms on the disc, wipe it off with a soft cloth. If moisture forms on the optical parts of the player, do not use the player for about one hour. The condensation will disappear naturally allowing normal operation.
2. Driving on extremely bumpy or rough roads can cause the disc to skip during playback.
3. This unit uses precision parts and components for its operation. In the event that trouble arises, never open the case, disassemble the unit, or lubricate the rotating parts. Contact your Clarion dealer or service center.
4. "Made for iPod," and "Made for iPhone" mean that an electronic accessory has been designed to connect specifically to iPod, or iPhone, respectively, and has been certified by the developer to meet Apple performance standards. Apple is not responsible for the operation of this device or its compliance with safety and regulatory standards. Please note that the use of this accessory with iPod or iPhone may affect wireless performance. iPhone and iPod are trademarks of Apple Inc., registered in the U.S. and other countries.

5. **DOLBY** DIGITAL

Manufactured under license from Dolby Laboratories.

"Dolby" and the double-D symbol are trademarks of Dolby Laboratories.

6. This product incorporates copyright protection technology that is protected by U.S. patents and other intellectual property rights. Use of this copyright protection technology must be authorized by Rovi Corporation, and is intended for home and other limited viewing uses only unless otherwise authorized by Rovi Corporation. Reverse engineering or disassembly is prohibited. Use of this product by the customer is restricted to play program materials to which the Rovi copyright protection process has been applied.

7. The Bluetooth® word mark and logos are registered trademarks owned by Bluetooth SIG, Inc. and any use of such marks by Clarion Co., Ltd, is under license.

8. DivX®, DivX Certified® and associated logos are trademarks of Rovi Corporation or its subsidiaries and are used under license.

DivX Certified® to play DivX® video, including premium content.

Covered by one or more of the following U.S. patents: 7,295,673; 7,460,668; 7,515,710; 7,519,274

ABOUT DIVX VIDEO: DivX® is a digital video format created by DivX, LLC, a subsidiary of Rovi Corporation. This is an official DivX Certified® device that plays DivX video. Visit divx.com for more information and software tools to convert your files into DivX videos.

ABOUT DIVX VIDEO-ON-DEMAND: This DivX Certified® device must be registered in order to play purchased DivX Video-on-Demand (VOD) movies. To obtain your registration code, locate the DivX VOD section in your device setup menu. Go to vod.divx.com for more information on how to complete your registration.

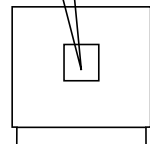

3. CAUTIONS ON HANDLING

Front Panel / Generalities

For a longer service life, be sure to read the following cautions.

- Do not allow any liquids on the unit from drinks, umbrellas, etc. Doing so may damage the internal circuitry.
- Do not disassemble or modify the unit in any way. Doing so may result in damage.
- Do not let cigarettes burn the display. Doing so may damage or deform the body.
- If a problem should occur, have the unit inspected at your store of purchase.
- The remote control unit may not work if the remote control sensor is exposed to direct sunlight.

Cleaning the body

- Use a soft, dry cloth and gently wipe off any dirt and/or dust.
- For tough dirt, apply some neutral detergent diluted in water to a soft cloth, wipe off the dirt gently, then wipe again with a dry cloth.
- Do not use benzene, thinner, car cleaner, etc., as these substances may damage the body or cause the paint to peel. Also, leaving rubber or plastic products in contact with the body for long periods of time may cause stains.

USB Port

- The USB memory sticks must be recognized as “USB mass storage class” to work properly. Some models may not operate correctly.
When the memorised data is lost or damaged by any chance, Clarion shall not be liable for any damage.
 When using an USB memory stick, we recommend that you backup your data stored on it before using a personal computer etc.
- Data files may be damaged when using a SD card in the following situation:
 When taking out the card or turning the power off while data on the card is being read.
 When affected static electricity or electric noise.
- Any issues that arise from connecting with a computer are not covered. Refer to computer or USB drive product manual.

SD Slot

- Please note: The standard SD card slot is for music, movie and/or background image files only. **The MicroSD card slot is for Navigation ONLY.** Only insert SD603AU navigation card.
- When using a SD card, we recommend that you backup your data stored on it before using a personal computer etc.
- Data files may be damaged when using a SD card in the following situation:
 When taking out the card or turning the power off while data on the card is being read.
 When affected static electricity or electric noise.
- Any issues that arise from connecting with a computer are not covered. Refer to computer or USB drive product manual.

Handling Discs

Handling

- New discs may have some roughness around the edges. If such discs are used, the player may not work or the sound may skip. Use a ball-point pen or the like to remove any roughness from the edge of the disc.

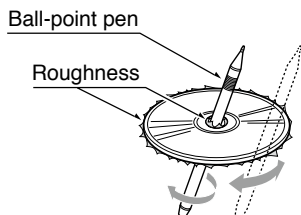

- Never stick labels on the surface of the disc or mark the surface with a pencil or pen.
- Never play a disc with any cellophane tape or other glue on it or with peeling off marks. If you try to play such a disc, you may not be able to get it back out of the player or it may damage the player.
- Do not use discs that have large scratches, are misshapen, cracked, etc. Use of such discs may cause misoperation or damage.
- To remove a disc from its storage case, press down on the center of the case and lift the disc out, holding it carefully by the edges.
- Do not use commercially available disc protection sheets or discs equipped with stabilizers, etc. These may damage the disc or cause breakdown of the internal mechanism.

Storage

- Do not expose discs to direct sunlight or any heat source.
- Do not expose discs to excess humidity or dust.
- Do not expose discs to direct heat from heaters.

Cleaning

- To remove fingermarks and dust, use a soft cloth and wipe in a straight line from the center of the disc to the circumference.
- Do not use any solvents, such as commercially available cleaners, anti-static spray, or thinner to clean discs.
- After using special disc cleaner, let the disc dry off well before playing it.

On Discs

- Never turn off the power and remove the unit from the car with a disc loaded.

CAUTION

For your safety, the driver should not insert or eject a disc while driving.

4. CONTROLS

Operational Panel

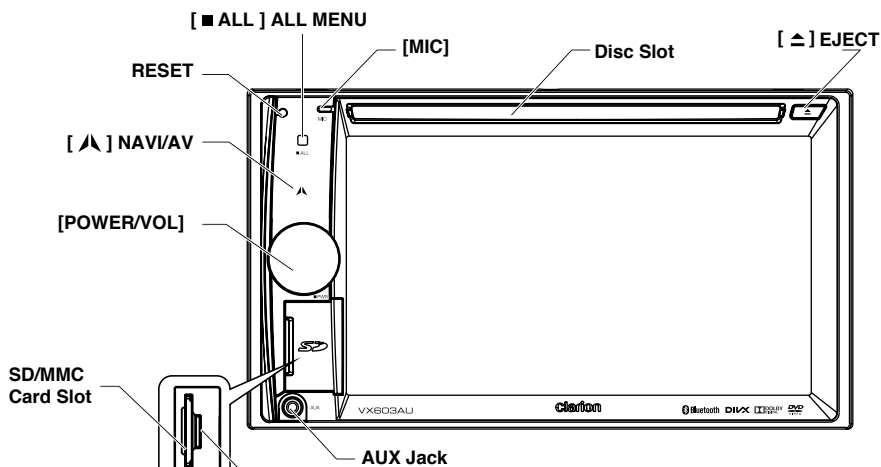

Micro SD card slot (Navigation ONLY)

Only for Clarion navigation map card. (Sold separately) Inserting anything other than specific navigation card may cause damage to the unit or your media.

Names of Buttons

[POWER/VOL] Knob

- Press to power on the system when ignition on.
- When power on, short press to mute the volume.
- Rotate the knob to increase or decrease the volume.
- Press and hold this key more than 1 second to turn off the system.

[ALL] ALL MENU Button

- Short press to show/exit shortcut menu.
- Long press to show/exit main source menu.

[NAVI/AV] Button (If optional Navigation installed)

- Press to enter navigation mode;
- Press again to return current source.

[EJECT] Button

- Press to eject disc.

[MIC] Hole

- Internal microphone

[RESET] Button

- Press to load original settings.

Note: When the [RESET] button is pressed, frequencies of radio stations, titles, etc. stored in memory are cleared.

Remote Control

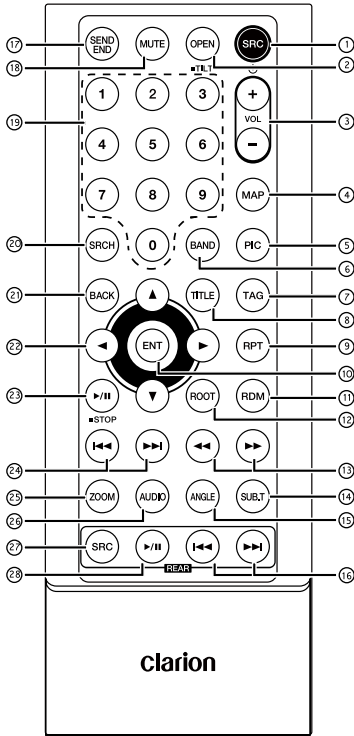

- ① **[SRC / ⏻] Button**
 - Show main source menu
 - Power on / Power off (long press)
- ② **[OPEN] Button**
 - Not used
- ③ **[+], [-] Buttons**
 - Adjust volume level
- ④ **[MAP] Button**
 - Enter navigation mode*
- ⑤ **[PIC] Button**
 - Adjust screen
- ⑥ **[BAND] Button**
 - Select tuner band
- ⑦ **[TAG] Button**
 - Not used
- ⑧ **[TITLE] Button**
 - DVD TITLE MENU
- ⑨ **[RPT] Button**
 - Repeat playback
- ⑩ **[ENT] Button**
 - Enter
- ⑪ **[RDM] Button**
 - Random playback
- ⑫ **[ROOT] Button**
 - DVD ROOT MENU
- ⑬ **[◀], [▶] Buttons**
 - Manual tune
 - Fast backward/forward playback
- ⑭ **[SUB.T] Button**
 - DVD subtitle
- ⑮ **[ANGLE] Button**
 - DVD angle
- ⑯ **[◀◀], [▶▶] Buttons (Rear)**
 - Chapter up/down
 - Fast backward/forward playback (long press)
- ⑰ **[SEND/END] Button**
 - Pick up
 - Hang up
- ⑱ **[MUTE] Button**
 - Mute the volume
- ⑲ **[0]~[9] Button**
 - Numeric key
- ⑳ **[SRCH] Button**
 - Number input mode
- ㉑ **[BACK] Button**
 - Back from source menu return to previous display
- ㉒ **[▲], [▼], [◀], [▶] Buttons**
 - Move cursor up/down/left/right

*Button only functions if Navigation installed

Remote Control

- 23 [▶/II/STOP] Button
- Play/Pause
 - Stop (long press)
- 24 [◀◀], [▶▶] Buttons
- **RADIO** mode
 - Previous / next preset station
 - Seek down/up (long press)
 - **DVD** mode
 - Previous/next chapter.
 - **CD/BLUETOOTH** mode
 - Previous/next track.
- 25 [ZOOM] Button
- ZOOM (DVD)
- 26 [AUDIO] Button
- DVD audio stream change.
- 27 [SRC] Button (Rear)
- Change next rear source
- 28 [▶/II] Button (Rear)
- Play/Pause
 - Stop (long press)

Use and care of the remote control

Using the remote control

Point the remote control in the direction of the front panel to operate.

When using for the first time, pull out the film protruding from the tray.

Replacing the battery

- 1 Slide out the back cover of the remote control.
2. Insert the battery with the plus (+) and minus (-) poles aligned properly.
 - When using for the first time, pull out the film protruding from the tray.
3. Close the back cover.

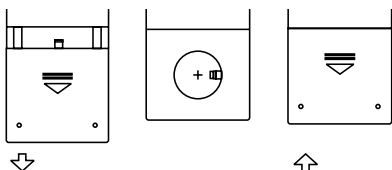

CAUTION

- Keep the battery out of the reach of children.
- Should the battery be swallowed, consult a doctor immediately.
- Batteries (battery pack or batteries installed) must not be exposed to excessive heat such as sunshine, fire or the like.

CAUTION

- Use one CR2025 (3 V) lithium battery.
- Remove the battery if the remote control is not used for a month or longer.
- There is a danger of explosion if the battery is incorrectly replaced. Replace only with the same or equivalent type.
- Do not handle the battery with metallic tools.
- Do not store the battery with metallic objects.
- If the battery leaks, wipe the remote control completely clean and install a new battery.
- When disposing of used batteries, comply with governmental regulations or environmental public institutions' rules that apply in your country/area.

► Important

- Do not store the remote control in high temperatures or direct sunlight.
- The remote control may not function properly in direct sunlight.
- Do not let the remote control fall onto the floor, where it may become jammed under the brake or accelerator pedal.

5. MAIN MENU OPERATIONS

Long press [**ALL**] button on the PANEL to show main source menu.

Short press [**ALL**] button to show Short cut menu.

Front Zone Source

Touch [-] on the bottom of screen to show front zone sources.

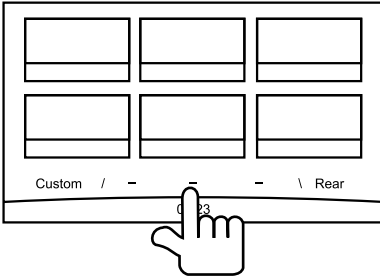

Change page by dragging left or right or touching other [-] buttons.

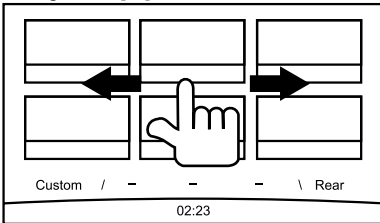

Touch the icons on the screen to enter corresponding work mode, such as Disc mode, Tuner mode, Telephone mode, etc. Touch [**Audio Off**] to mute the volume.

Rear Zone Source

Touch [**Rear**] on the bottom of screen to show rear zone sources.

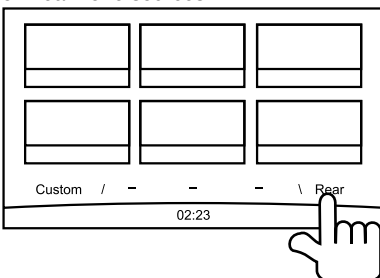

Touch the icons on the screen to enter corresponding work mode, such as Disc mode, USB mode, iPod mode, etc.

Touch [**2ZoneOff**] to turn off the rear zone monitor.

Custom Setting

Touch [**Custom**] on the bottom of screen to show custom setting menu.

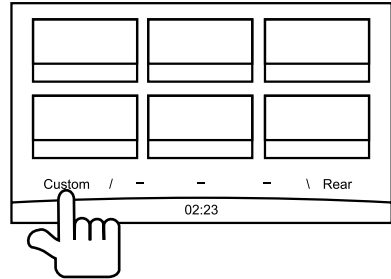

[**Settings**]: Touch the icon to enter system setting menu. (see "System Setup")

[**Beat EQ**]: Touch the icon to enter equalizer setting menu. (see "System Setup")

[**Short Cut**]: Touch the icon to enter Shortcut setting menu. Hold the desired icon for more than 2 seconds until it's activated, then drag it to the bottom. The name will appear on the bottom.

- Hold the center of the screen and drag left or right to show more icons.
- You can make total 5 shortcuts.
- You can access the shortcut list by pressing the [**ALL**] button.

[**Illumi Color**]: Touch the icon to enter Illumination color setting menu. (see "System Setup")

[**Wallpaper**]: Touch the icon to enter Wallpaper setting menu. (see "System Setup")

[**Monitor Off**]: Touch the icon to turn off the monitor.

To turn on the monitor, touch the monitor again.

6. SYSTEM SETUP

In all modes, long press [**ALL**] button to enter main source menu. Touch [**Custom**] on the bottom left of the screen, then select [**Settings**] on the screen to enter Setting menu. Touch the icons on the left of screen to select category: General, Time, Sound, Display or Setup. To exit Setting menu, touch [**BACK**] on the bottom left of the screen.

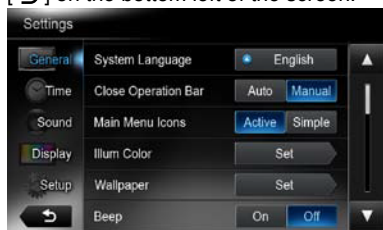

General

System language

Touch the button to the right of “System language” to show language list. Select desired language, touch [**OK**] to confirm, or touch [**Cancel**] to exit without saving.

Close operation bar

When select [**Auto**], the operation bar will close automatically after 10 seconds.

When select [**Manual**], the operation bar will not close unless you touch the blank area on the screen.

Main Menu Icons

When select [**Active**], main menu show animation icons.

When select [**Simple**], main menu show simple icons.

Illumi Color

Touch [**Set**] to the right of “Illumi Color” to show key illumination setting menu.

Edit Color: There are 12 preset colors and 3 custom colors, you can select one color by touch color 1~12 or Custom 1~3.

Touch [**Adjust**] to show edit color menu.

Drag the color bar or inputting the RGB value to select one color, touch [**OK**] to confirm.

Initialize: Load original buttons backlight.

Touch [**BACK**] on the bottom left of the screen to return to main setting menu.

Wallpaper

Touch [**Set**] to the right of “Wallpaper” to show Wallpaper setting menu.

Touch [**◀**] or [**▶**] button to select the scene, and touch the picture file name on the right to preview it, then touch [**Set**] to confirm the setting.

To import images, touch [**Import**].

Select a mobile storage device on the list, then select desired images and touch [**Import**]. Touch [**Cancel**] to exit.

Beep

Touch [**On**] or [**Off**] to turn on/off the key beep sound.

Blinking LED

Touch [**On**] or [**Off**] to turn on/off the blinking LED.

At blinking LED [**On**] mode, when ACC off, the LED on the top left of the panel will blink.

Amplifier cancel

Touch [**On**] or [**Off**] to set the internal amplifier on or off.

System software

Touch [**Version**] to show current software version.

Factory default

Touch [**Restore**] to load the original factory settings.

Time

GPS sync (requires Navigation)

Touch [**On**] to synchronize time with GPS and the following setting is disable: “Time”.

Time

Touch the button to the right of “Time” to show time setting menu. Touch [**▲**] or [**▼**] button to select hour or minute. Touch [**Set**] to confirm or [**Back**] to exit without saving.

24-Hour format

Touch [**On**] to select 24-Hour format.

Touch [**Off**] to select 12-Hour format.

Sound

Beat EQ

Touch the button to the right of “Beat EQ” to show EQ setting menu. You can select : “Bass Boost”, “Impact”, “Excite”, “Custom” or “Off”.

To adjust the value, touch [-] or [+] button on the screen.

Touch [**Back**] to exit.

Balance/Fader

Touch [**Set**] to the right of “Balance/Fader” to show Balance/Fader setting menu.

Touch [▲] or [▼] button to adjust Fader, and touch [◀] or [▶] button to adjust Balance.

Touch [**Center**] to reset the value.

Touch [**Back**] to exit.

Sub woofer control

Touch [-] or [+] button on the right of “Sub woofer control” to adjust sub woofer level.

Sub woofer phase

Touch to select sub woofer phase Normal or Reverse.

High pass filter

Touch the button to the right of “High pass filter” to show the sub-menu, then select the filter: “Through”, “55Hz”, “85Hz” or “120Hz”.

Touch [**Cancel**] to exit.

Low pass filter

Touch the button to the right of “Low pass Filter” to show the sub-menu, then select the filter: “Through”, “62Hz”, “95Hz” or “135Hz”.

Touch [**Cancel**] to exit.

Magna Bass Ex

Touch [**On**] to turn on the loudness.

Display

Dimmer Mode

Touch [**Auto**], [**Day**] or [**Night**] to choose dimmer mode.

Auto: The dimmer is controlled by your car light.

Dimmer

Touch [-] or [+] button to the right of “Dimmer” to adjust dimmer.

The setting is only for Day or Night.

Setup

Touch [**Setup**] on the right of screen to spread the setting list. then touch the button to the right of desired option to adjust or show the sub-menu. Touch [**Close**] to close the list.

AUX

- **Input Aux Sense (AUX1)**
Choose “Low”, “Middle” or “High” input sense of auxiliary device.

Bluetooth

- **Bluetooth**
Choose Bluetooth function on or off.
- **Telephone Speaker**
Choose Front Left or Front Right speaker at telephone mode.
- **Tone Select**
Touch [**Auto**] to use ringtones of your mobile phone.
Touch [**Internal**] to use preset ringtone of the unit.
- **Software Update**
Update the software.

Camera

- **Camera Interrupt**
Choose [**On**], the screen will switch to rear camera menu automatically when backing.

DVD

- **Menu Language**
Select menu language from list.
- **Audio Language**
Select audio language from list.
- **Subtitle Language**
Select subtitle language from list.
- **Set Password**
To set password for parental control,
Touch [**Set**] to show password menu.

Input numbers by touching the digit and [OK] buttons. Touch [X] button to delete a digit inputted. Touch [Back] to exit.

- **Parental Control**

Touch the button to the right of “Parental Control” to show parental control menu. Enter password, then select a parental level. Touch [OK] to confirm or [Back] to exit.

Navigation

- **Navigation Interrupt**

Select navigation interrupt On, Pop-Up or Off.

- **Voice Guidance**

ON: Interrupt function of voice guidance is on. While interrupting no attenuate function of AV sound.

MUTE: Interrupt function of voice guidance is on. While interrupting attenuate function of AV sound is on.

OFF: Interrupt function of voice guidance is off. While interrupting no attenuate function of AV sound.

Note:

Navigation Interrupt / Voice Guidance settings only when optional navigation is installed.

PANDORA

- **PANDORA**

Select PANDORA On or Off.

If your iPhone has the Pandora® application installed, please select on, otherwise set off.

Anti Theft

- **Anti Theft code**

You can set an Anti-theft code. After set successfully, when Battery wire reconnect, you need to input the Anti-theft code.

1. Long press the [General] button until a dialog box popped up. Touch [Yes] to set a personal code of Anti-Theft.

2. Input a 4-digit code. Touch [OK] to confirm. Then input it again for confirmation.

To remove the code, long press the [General] button and input the old password.

Note:

Please make a note of the Anti theft code not to forget. if the right code is not inputted, it becomes impossible to operate this unit.

7. DISC OPERATIONS

DVD System

DVD video is a high-quality digital video source that provides crisp and clear images. One 12 cm disc contains either one film or four hours of music.

DVD Video Features

This unit provides the following functions in addition to the high image quality and sound quality of DVD video.

Notes:

- The functions described in this section, for example, the recorded language, subtitles, angles, etc. differ depending on the DVD video disc.
Refer to the instructions provided with the DVD video.
- Some disc functions may operate differently from described in this manual.

Multi-sound function

DVD video can store up to 8 languages for one film; select the language of your preference.

- The languages stored on the disc are indicated by the icon shown below.



Multi-angle function

A DVD video that is filmed from multiple angles allows you to select the angle of choice.

- The number of recorded angles are indicated by the icon shown below.



Subpicture (subtitles) function

A DVD video can record subtitles for up to 32 languages and you can select the language of the subtitles you wish to see.

- The number of recorded subtitle languages are indicated by the icon shown below.



Multi-story function

When a DVD video contains more than one story for a film, you can select the story you wish to enjoy.

The operation procedures vary with the disc; observe the instructions for selecting a story provided during playback.

Menu screens

Menu can be called up during DVD video playback to perform menu setting.

- Example showing menu display

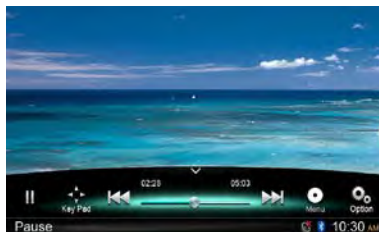

Discs

Playable discs

This DVD video player can play the following discs.

Playable discs		
 DVD video discs	 Audio CDs	 CD TEXT

Playable media files		
 MP3/WMA	 DivX	 MP4

About CD Extra discs

A CD Extra disc is a disc in which a total of two sessions have been recorded. The first session is Audio session and the second session is Data session. Your personally-created CDs with more than second data

sessions recorded cannot be played on this DVD video player.

Note:

- *When you have a CD Extra disc, only the first session will be recognized.*

About playing a CD-R/CD-RW disc (MP3, WMA)

This player can play CD-R/CD-RW discs previously recorded in music CD format (MP3, WMA)

About playing a DVD-R/RW or DVD+R/RW disc

This player cannot play DVD-R/RW and DVD+R/RW discs previously recorded in video CD format.

However, MP3/WMA files recorded on DVD-R/RW and DVD+R/RW discs can be played.

Discs that cannot be played back

This DVD video player cannot play back DVD-Audio, DVD-RAM, Photo CDs, etc.

Note:

- *It may also not be possible to play back CDs recorded on a CD-R unit and CD-RW unit. (Cause: disc characteristics, cracks, dust/dirt, dust/dirt on player's lens, etc.)*
- *If a CD-R or CD-RW disc that has not been finalized is played, it will take a long time to start playing. Also, it may not be possible to play depending on its recording conditions.*
- *You cannot play SuperAudio CDs Playback of the CD player is not supported even if it is a hybrid disc.*

About MP3/WMA playback

This unit can play back CD-R/CD-RW, DVD-R/RW and DVD+R/RW discs on which MP3/WMA music data have been recorded.

For a detailed information, see the section entitled "Listening to MP3/WMA".

Note on region numbers

The DVD video system assigns a region number to DVD video players and DVD discs by sales area. DVD video players sold in Australia can play back DVD discs with the region number "ALL", "4" or any combination

of numbers that also incorporate a "4".

The DVD video region number is marked on the disc jacket as shown below.



Accessing a Disc

CAUTION

For your safety, the driver should not insert or eject a disc while driving.

Eject function

Just pressing the [] button, ejects the disc even if the power to the unit was not turned on.

Notes:

- *If you force a disc into before auto reloading, this can damage the disc.*
- *If a disc (12 cm) is left ejected for 15 seconds, the disc is automatically reloaded (Auto reload).*

Listening to a disc already loaded in the unit

Long press [ ALL] button to enter main source menu, then select [Disc] to enter Disc mode.

If Disc is not on the current source menu, touch [-] buttons on the bottom of the screen, or hold the center of screen and drag left/right to show more icons.

When the unit enters the Disc mode, play starts automatically.

Loading a disc

Insert a disc into the center of the disc slot with label facing up. The disc plays automatically after loading.

Notes:

- *Never insert foreign objects into the disc slot.*
- *If the disc is not inserted easily, there may be another disc in the mechanism or the unit may require service.*

DVD Player Operations

Playback menu

Touch the bottom half of screen to show operation bar.

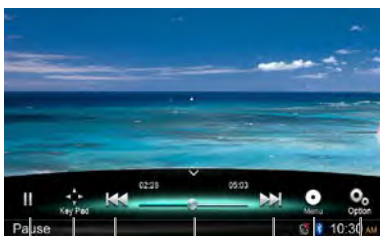

1. Play/Pause/Stop(long press)
2. Show cursor keys in DVD title menu
3. Previous chapter
Fast-backward (long press)
4. Progress bar
5. Next chapter
Fast-forward (long press)
6. Root menu
Root Title (long press)
7. Show other options



8. Repeat play
9. Select audio language
10. Select subtitle language
11. Show next page
12. Select DVD angle
13. Back to main operation bar

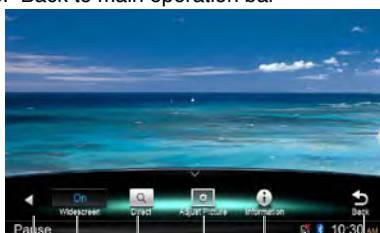

- 14
- 15
- 16
- 17
- 18
- 19
- 13

14. Show previous page
15. Turn on Widescreen mode
16. Direct search
17. Adjust picture effect
18. Show playback information
19. Mute indicator

Pausing play

1. Touch the [||] button on the screen to pause play.
2. Touch [▶] button to resume play.

Selecting a chapter

Chapter-up

Touch the [▶▶] button to move to the beginning of the next chapter.

Chapter-down

Touch the [◀◀] button to move back to the beginning of the current or previous chapter.

Fast forward/Fast reverse

Fast forward

Touch and hold the [▶▶] button for more than 2 seconds.



Fast reverse

Touch and hold the [◀◀] button for more than 2 seconds.

Repeat

During playback, touch [], [**Repeat**] buttons to repeat play.

Search function

During playback, touch [], [] buttons to show search menu.

Input number by digit buttons, touch [**OK**] to begin searching or touch [**Close**] to clear inputting.

Touch [**Chapter**] or [**Title**] to show DVD chapter/title list.

DVD audio select

During playback, touch [], [**Audio**] buttons to select audio language to listen if the DVD has multiple audio languages.

DVD subtitle select

During playback, touch [], [**Subtitle**] buttons to select the subtitle language if the DVD has multiple language subtitles.

Playback information

During playback, touch [], [**Information**] buttons to view playback information.

Adjust picture

During playback, touch [], [**Adjust Picture**] button, then use [-], [+] buttons to adjust Dimmer/Brightness/Contrast/Color.

DVD angle select

During playback, touch [], [**Angle**] buttons to select different angle to view if the DVD has multiple-angle views.

CD Player Operations

Playback menu

Touch the bottom half of screen to show operation bar.



1. Show track list (Browse)
2. Title/Artist/Album information
3. Play/Pause
4. Repeat play
5. Previous track
Fast reverse (long press)
6. Progress bar
7. Next track
Fast forward (long press)
8. Random play
9. Show other options
Scan: Scan play stored stations

Browse mode

Touch the [List] button to show track list. Drag up/down to browse the tracks, and touch desired track to select it.

Pausing play

1. Touch the [||] button on the bottom left of the screen to pause play. "PAUSE" appears in the display, and [||] button becomes [▶].
2. Touch [▶] button to resume play.

Selecting a track

Track-up

1. Touch the [▶▶] button to move to the beginning of the next track.

Track-down

1. Touch the [◀◀] button to move back to the beginning of the current track.

2. Touch the [◀◀] button twice to move back to the beginning of the previous track.

Fast forward/Fast reverse

Fast forward

Touch and hold the [▶▶] button.

Fast reverse

Touch and hold the [◀◀] button.

- * For MP3/WMA discs, it takes some time until the start of searching and between tracks. In addition, some error may occur in the play time.

Search Function

1. Touch the [List] button to show track list. Touch [Q] button to enter search menu.
2. Input numbers by touching digit buttons, then touch [Search] to begin searching. To delete numbers, touch [⏏] button.
3. Touch [●] button to exit.

Other various play functions

Scan play

This function allows you to locate and play the first 10 seconds of all the tracks recorded on a disc.

Touch the [Q] button, then touch [Scan] to scan play.

Repeat play

This function allows you to play the current track repeatedly or play a track currently being played in the MP3/WMA folder repeatedly.

Touch the [↺] button to select Track Repeat, Folder Repeat or All Repeat.

Random play

This function allows you to play all tracks recorded on a disc in a random order.

Touch the [↻] button to perform random play.

MP3/WMA Playback

This unit is an ID3 Tag compatible model. This unit supports the ID3 TAGs of the Version 2.4, 2.3, 1.1 and 1.0. In displaying, this unit gives priority to the Version 2.3 and 2.4 TAGs.

What is MP3/WMA

MP3 is an audio compression method and classified into audio layer 3 of MPEG standards.

WMA is an audio compression method developed by Microsoft Corporation. These audio compression methods have penetrated into PC users and become a standard format.

These features compress the original audio data to about 10 percent of its initial size with a high sound quality. This means that about 10 music CDs can be recorded on a CD-R disc or CD-RW disc to allow a long listening time without having to change CDs.

Note: Some CDs recorded on CD-R/RW mode may not be usable.

Displaying MP3/WMA TAG titles

Tag information such as title, artist and album title can be displayed for MP3/WMA file containing Tag information.

Precautions when creating MP3/WMA file

Usable sampling rates and bit rates

1. MP3: Sampling rate 8 kHz-48 kHz, Bit rate 8 kbps-320 kbps / VBR
2. WMA: Bit rate 8 kbps-320 kbps

File extensions

1. Always add a file extension “.MP3”, “.WMA” to MP3, WMA file by using single byte letters. If you add a file extension other than specified or forget to add the file extension, the file cannot be played.
2. Files without MP3/WMA data will not play. The files will be played soundlessly if you attempt to play files without MP3/WMA data.
 - * When VBR files are played, the play time display may differ the play location.
 - * When MP3/WMA files are played, a little no sound part is caused between tunes.

Logical format (File system)

When writing MP3/WMA file on a CD-R disc or CD-RW disc, please select “ISO9660 level 1, 2 or Joliet or Romeo” or Apple ISO as the writing software format. Normal play may not be possible if the disc is recorded on another format.

Folder structure

A disc with a folder having more than 8 hierarchical levels will be impossible.

Number of files or folders

1. Up to 999 files can be recognized per folder.
 - Up to 6000 files can be played.
2. Tracks are played in the order that they were recorded onto a disc. (Tracks may not always be played in the order displayed on the PC.)
3. Some noise may occur depending on the type of encoder software used while recording.

Playing MP3 folders

When selected for play, files and folders (Folder Search, File Search or Folder Select) are accessing in the order in which they were written to the media.

As a result, the order in which they are expected to be played may not match the order in which they are actually played.

You may be able to set the order in which MP3/WMA files are to be played by assigning file names beginning with play sequence numbers such as “01” to “99”.

For example, a medium with the following folder/file hierarchy is subject to Folder Search, File Search or Folder Select.

See the diagram below.

The player will only recognize three folder levels and does not display folders containing other folders. In the example below, the unit will display folders 2, 3, 5 and 7. It will not display folders 1, 4 and 6. (folder inside folder)

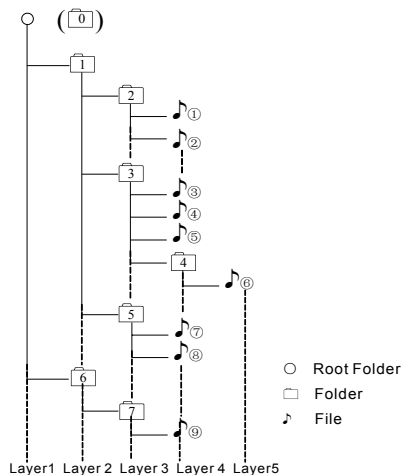

Playback menu

Touch the bottom half of screen to show operation bar.



1. Show folder/file list (Browse)
2. Folder/Title/Artist/Album information
3. Play/Pause
4. Repeat play
5. Previous track
6. Progress bar
7. Next track
8. Fast reverse (long press)
9. Fast forward (long press)
9. Show other options



10. Scan play
11. Rotate the album image
12. Back to main operation bar

Folder Select

This function allows you to select a folder containing MP3/WMA files and start playing from the first track in the folder.

Touch the [List ≡] button on the upper left of the screen to show folder/file list. You can select a folder or file by touching it.

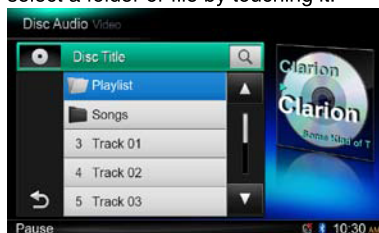

Search Function

1. Touch the [List ≡] button to show folder/file list. Touch [Q] button to enter search menu.
2. Input numbers by touching digit buttons, then touch [Search] to begin searching. To delete numbers, touch [X] button.



Other operations about playing MP3/WMA are same as CD Player mode.

MP4/DivX Playback

Playback menu

When playing, touch the bottom half of screen to show operation bar.

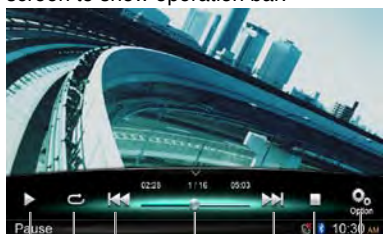

1. Play/Pause
2. Repeat playback
3. Previous file
Fast reverse (long press)
4. Progress bar
5. Next file
Fast forward (long press)
6. Stop and show list menu (Browse)
7. Show other options

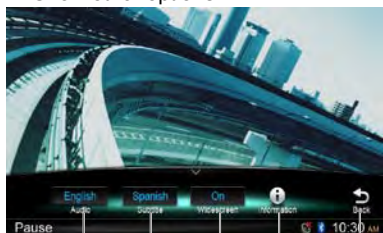

8. Select audio language
9. Select subtitle language
10. Turn on Widescreen mode
11. Show playback information
12. Back to main operation bar

Browse mode

Touch the [■] button to show folder/file list.
Drag up/down to browse, and touch desired option to select it.

Pausing play

1. Touch the [||] button on the screen to pause play.
"|| PAUSE" appears in the display.
2. Touch [▶] button to resume play.

Selecting a file

File-up

Touch the [▶▶] button to move to the beginning of the next file.

File-down

Touch the [◀◀] button to move back to the beginning of the current or previous file.

Fast forward/Fast reverse

Fast forward

Hold the [▶▶] button .

Fast reverse

Hold the [◀◀] button .

Repeat play

This function allows you to play the current file repeatedly or play files currently being played in the folder repeatedly.

Touch the [↺] button to select File Repeat, Folder Repeat, All Repeat or Repeat Off.

Search function

1. At video main menu, touch the [■] button to show folder/file list.
2. Touch [🔍] button to enter search menu.
3. Input numbers by touching digit buttons, then touch [Search] to begin searching.
To delete numbers, touch [⌫] button.

Audio select

Touch the [Option] button and touch [Audio] button to select audio language to listen if the file has multiple audio languages.

Subtitle select

Touch the [Option] button and touch [Subtitle] to select the subtitle language if the file has multiple language subtitles.

8. SD/USB OPERATIONS

Accessing an USB

1. Insert an USB device into the USB cable.
When connecting an USB device, the unit will read the files automatically.
2. To remove the USB device, you should first select another source or turn off the power, in order to avoid damaging the USB device. Then take off the USB device.
3. To access an USB device already connected to the unit, long press [**ALL**] button to enter main source menu, then select [**USB**] to enter USB mode.
If [**USB**] is not on the current source menu, touch [-] buttons on the bottom of the screen, or hold the center of screen and drag left/right to show more icons.

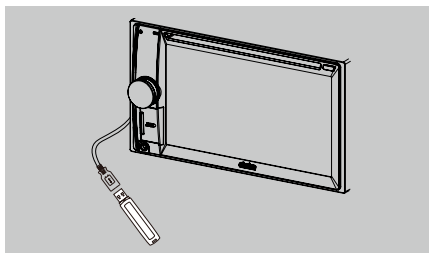

Accessing an SD Card

1. Slide the cover of the card slot located on the bottom left of the panel to the right. Insert a standard SD card into the card slot. When inserting a card, the unit will read the files automatically.
2. To remove the card, you should first select another source or turn off the power, in order to avoid damaging the card. Press to pop it out, then take off the card. Close the cover to the left.
3. To access an SD card already inserted in the unit, long press [**ALL**] button to enter main source menu, then select [**SD**] to enter SD mode.
If [**SD**] is not on the current source menu, touch [-] buttons on the bottom of the screen, or hold the center of screen and drag left/right to show more icons.

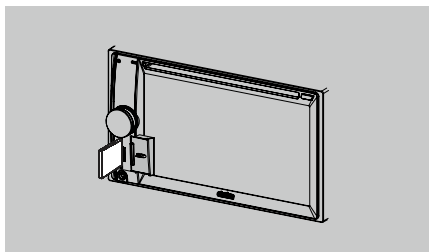

Use standard SD card only. The MicroSD card slot is for SD603AU Navigation MicroSD card ONLY. (SD603AU sold separately)

SD/USB Audio Operations

This system can play audio files (MP3/WMA) stored in an SD card or USB memory. You can use it as an audio device by simply copying desired MP3/WMA files onto the SD/USB.

Notes:

- *This system will not operate or may operate improperly with some card or USB.*
- *Files protected with any DRM cannot be played.*

Select SD/USB Audio mode

Touch top left corner of the screen until SD Audio or USB Audio appears.

Operation about SD/USB audio is same as MP3/WMA playback mode.

SD/USB Video Operations

This system can play video files (MP4, etc) stored on a SD card or USB device. You can use it as an video device by simply copying desired video files onto the SD/USB.

Notes:

- *This system will not operate or may operate improperly with some cards or USB devices.*
- *Files protected with any DRM cannot be played.*
- *DivX playback is only supported via USB*

Operations about SD/USB video operations are same as MP4/DivX playback mode.

9. BLUETOOTH OPERATIONS

The Bluetooth allows you to utilize your car's built-in audio system for wireless mobile phone or music handsfree communication. Some Bluetooth mobile phones have the audio features, and some portable audio players support Bluetooth feature. This system can play audio data stored in a Bluetooth audio device. The car stereo with Bluetooth will be able to retrieve phonebook contacts, received call, dialled call, missed call, incoming calls, outgoing call and listen to music.

Notes:

- Do not set the microphone of Bluetooth handsfree in the places with wind passing such as air outlet of the air conditioner, etc. This may cause a malfunction.
- If set it in the places subjected to direct sun, high temperature can cause distortion, discoloration which may result in a malfunction.
- This system will not operate or may operate improperly with some Bluetooth audio players.
- **Clarion** cannot guarantee the compatibility of all mobile phones together with the unit.
- Audio playback will be set to the same volume level as set during telephone call. This might cause problems, if extreme volume level is set during telephone call.

Bluetooth Telephone Operations

Pairing

1. Turn on the Bluetooth function of the unit. (see <System Setup>, <Bluetooth>)
2. Turn on Bluetooth function of your mobile phone.
3. Enter mobile phone's Bluetooth setup menu.
4. Search for new Bluetooth devices.
5. Select **VX603AU** from the found devices list on the mobile phone.
6. Enter "0000" as the password.
7. After pairing successfully,  indicator on the bottom right of the screen turns blue.

During pairing, depending on type of mobile phone, a six digit PIN code will be shown on both the source unit's display and the mobile phone.

In this case, please make sure that you have the same PIN code on both devices, and then confirm on the mobile phone.

Search from the unit

You can search Bluetooth device from the unit.

1. Touch **[Add]** on the right of the screen, the unit will search the Bluetooth devices and list on the screen.
2. If your desired device isn't on the list, touch the button on the bottom left of the screen to refresh.

To stop searching, touch **[Cancel]**.

3. Touch the device name on the screen to select it, then input PIN code on the sub-menu.
4. After paired successfully, select device image, touch **[OK]** to confirm.
5. If connect unsuccessfully, select **[Retry]** to reconnect or select **[Cancel]** to return to list menu.

Choose paired device

After paired, the mobile device information appears on the right of screen, such as model number, Signal, Battery.

1. To select other paired device, hold the middle right of the screen, and drag it left or right, touch it to show control buttons.
2. Touch **[Connect]** to connect the Bluetooth device. Touch **[Cut]** to disconnect.
3. Touch  to delete the paired device from pairing list.

Telephone menu

Long press **[ALL]** button to enter main source menu, then select **[Telephone]** to enter telephone mode.

If **[Telephone]** is not on the current source menu, touch **[-]** buttons on the bottom of the screen, or hold the center of screen and drag left/right to show more icons.



1. Show history categories
2. Backspace
3. Paired device information
4. Number pad
5. Call/Hang up

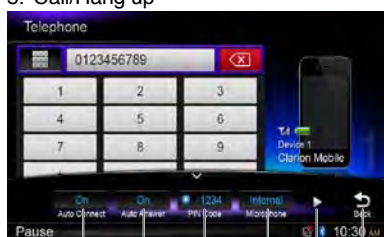

6. Turn on/off Auto Connect function
7. Turn on/off Auto Answer function
8. Set PIN code
9. Select internal or external microphone
10. Show next page
11. Back to main operation bar

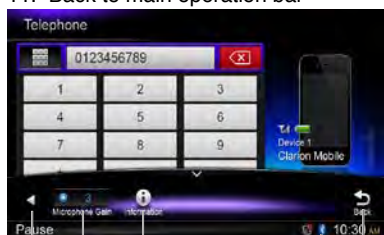

12. Show previous page
13. Adjust microphone gain
14. Show Bluetooth information
15. Bluetooth indicator

Making a call

• Dial Number

1. Input numbers by digit-keys on the screen.
2. Touch [] button to dial.
Touch [] button to delete characters.
3. Touch [] button to terminate call.

• Dialed/Received/Missed Call History

You can search any Dialed/Missed/Received Call History.



1. Touch [] button to show following history categories: Dialed, Received, Missed and Contacts.
Touch [] to dial number manually.
2. Touch to select a category, the numbers of the category are displayed.
3. Select a number, touch [] button to dial.
Touch [] to return previous menu.

• Call from Phonebook

You can search the contact name in the phonebook and make call.

1. Touch [] button and select [**Contacts**].
It may take a few minutes to synchronize the phone book at first time.
2. Select a number, touch [] button to dial.
Touch [] to return previous menu.

Note:

Some cellular phones may not be able to transfer the Phone Book data.

• Answering a call

You can answer an incoming call by pressing the [] button.

- * Touch [] button to reject an incoming call.

Bluetooth Audio Operations

Audio Streaming Operation

What is audio streaming?

Audio streaming is a technique for transferring audio data such that it can be processed as a steady and continuous stream. Users can stream music from their external audio player to their car stereo wirelessly and listen to the tracks through the car's speakers. Please consult your nearest **Clarion** dealer for more information on the product of wireless audio streaming transmitter offered.

⚠ CAUTION

Please avoid operating your connected mobile phone while audio streaming as this may cause noise or sound choppy on the song playback.

Audio streaming may or may not resume after telephone interrupt as this is dependent on mobile phone.

Note:

Be sure to read the chapter "Pairing" and "Choose paired device" before proceeding.

Playback menu

Touch the bottom half of screen to show operation bar.



1. Title/Artist/Album information
2. Play/Pause
3. Previous track
Fast reverse (long press)
4. Stop
5. Next track
Fast forward (long press)

Play / Pause a track

1. Touch the [⏸] button to pause audio playback.
2. To resume audio playback, touch the [▶] button.

Selecting a track

Track-up

1. Touch the [⏮] button to move to the beginning of the next track.
2. Each time you touch the [⏮] button, the track advances to the beginning of the next track.

Track-down

1. Touch the [⏭] button to move back to the beginning of the current track.
2. Touch the [⏭] button twice to move back to the beginning of the previous track.

Stop playback

Touch [■] button to stop playback.

Note:

Playing order will depend on Bluetooth audio player. When [⏮] button is pressed, some A2DP devices will restart the current track depends on the duration of playback. Some Bluetooth audio players may not have play/pause synchronized with this unit. Please make sure both device and main unit are in the same play/pause status in Bluetooth Audio mode.

10. RADIO OPERATIONS

Select tuner for listening to the radio

Long press [**ALL**] button to enter main source menu, then select [**Tuner**] to enter Tuner mode.

If Tuner is not on the current source menu, touch [-] buttons on the bottom of the screen, or hold the center of screen and drag left/right to show more icons.

Menu of listening to the radio

Touch the bottom half of screen to show operation bar.

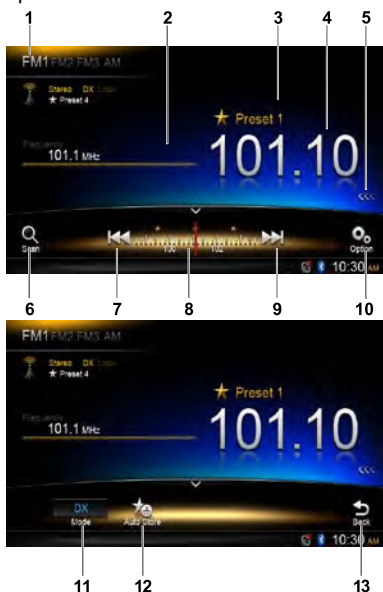

1. Band switch
2. Information area
3. Preset station number
4. Current station frequency
5. Show preset stations list
6. Scan preset stations
7. Manual tune backward
Auto tune backward. (long press)
8. Frequency bar
9. Manual tune forward
Auto tune forward. (long press)
10. Show other options
11. Choose local or distant seeking mode
12. Store stations automatically
13. Back to main operation bar

Select one radio band

Touch the top left corner of the screen to select one radio band among FM1, FM2, FM3 and AM.

Manual tuning

During manual tuning, the frequency will be changed in steps.

Touch the [**◀◀**] or [**▶▶**] button on the operation bar to tune in a higher / lower station.

Auto tuning

Hold the [**◀◀**] or [**▶▶**] button on the operation bar for more than 2 seconds to seek a higher / lower station.

To stop searching, repeat the operation above or press other buttons having radio functions.

Note:

When a station is received, searching stops and the station is played.

Preset scan

Preset scan receives the stations stored in preset memory in order. This function is useful when searching for a desired station in memory.

1. Touch the [**Scan**] button on the operation bar.
2. When a desired station is tuned in, press the [**Stop**] button to continue receiving that station.

Auto store

Only stations with sufficient signal strength will be detected and stored in the memory.

To start automatic station search, touch following buttons on the operation bar in sequence: [**AS**] -> [**AS**] -> [**OK**].

To stop auto store, press other buttons having radio functions.

Notes:

1. After auto store, the previous stored stations will be overwritten.
2. The unit has 4 bands, such as FM1, FM2, FM3 and AM. FM3 and AM can store by AS function. Each bands can store 6 stations, VX603AU can store 24 stations in total.

Manual store

When one expected radio station has been detected, touch [<<<] button on the right edge of the screen to show the preset station list, hold one of the six preset stations for more than 2 seconds to store it in the memory. Touch [>>>] button near the center of screen to hide the preset station list.

Recall the stored stations

Touch [<<<] button on the right edge of the screen to show the preset station list, touch to select a preset station. Touch [>>>] button near the center of screen to hide the preset station list.

Local seeking

When LOCAL seeking is on, only those radio stations with strong radio signal could be received.

To open LOCAL function, touch [] button on the operation bar, then touch the [Mode] button to select "Local" or "DX".

Note:

The number of radio stations that can be received will decrease after the local seeking mode is on.

11. Pandora® OPERATION

Pandora®, the leading internet radio service, gives people music they love anytime, anywhere, through personalized radio stations available on a wide variety of connected devices.

To stream Pandora internet radio, please do the following:

1. Connect a compatible iPhone to the unit. (refer to “Wiring and Connections”).
2. Touch the Pandora icon from the Main Source Menu and open Pandora mode.
3. Pandora will automatically start streaming. If it does not start automatically, please launch the Pandora App on the iPhone.

Touch the bottom half of screen to show operation bar.



1. Show station list
2. Song/Title/Artist/Album information
3. Play/Pause
4. Skip
5. Thumbs Down
6. Progress bar
7. Thumbs Up
8. Add bookmark
9. Show other option



10. Create a new station
11. Back to main operation bar

Add bookmark

Touch [] button, then select [Track] or [Artist] to add it to the bookmark list.

Create a new station

Touch [] button and [New Station] button. Then select [Track] or [Artist] to add it to the station list.

Thumbs up/down

Touch [] icon, “Thumbs-Up” feedback will be sent to the Pandora station.

Touch [] icon, “Thumbs-Down” feedback will be sent to the Pandora station.

Note:

Pandora limits the number of skips allowed on their service. If you attempt to skip songs beyond the limit, “SKIP LIMIT” is displayed. If you give a track the thumbs down after the skip limit has been exceeded, your feedback will be saved but the current track will continue to play.

Select a stored station

Touch [] button to show station list.

Touch [By Date] to list the stations by date.

Touch [A-Z] to list the stations from A to Z.

Drag up or down to scroll the list, select a desired station to play it.



12. iPod & iPhone OPERATIONS

Connect an iPod or iPhone to the USB connector via CCA-750 cable.

When connecting a device, the unit will read the files automatically. The track information display on the screen once playback start.

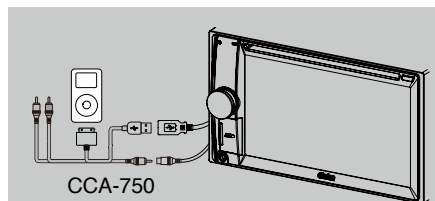

iPod® / iPhone® video support only available for pre- "lightning" (30-PIN) connector.

Accessing iPod mode

Long press [**ALL**] button to enter main source menu, then select [**iPod**] to enter iPod mode.

If [**iPod**] is not on the current source menu, touch [-] buttons on the bottom of the screen, or hold the center of screen and drag left/right to show more icons.

At iPod Audio mode, touch the bottom half of screen to show operation bar.

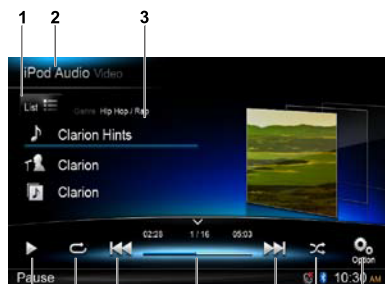

1. Show file list (Browse)
2. Switch between iPod Audio and Video
3. Song/Artist/Album information
4. Play/Pause
5. Repeat play
6. Previous track
Fast reverse (long press)
7. Progress bar
8. Next track
Fast forward (long press)
9. Random play
10. Show other options



11. Turn on / off Simple Control
12. Select Audiobook play speed
13. Back to main operation bar

Browse mode

1. Touch the [**List**] button to show file list.
Drag up/down to browse. Touch a item of list on the screen to select it.
2. Touch [**Play**], [**Next**] and [**Previous**] buttons to show the following categories: Playlists, Songs, Artists, Albums, Genres, Composers, Audiobooks, Podcasts.
3. Touch to select a category, the contents of the category are displayed. Drag up/down to browse.
4. Touch an option to select it.

Pausing play

1. Touch the [**Pause**] button on the bottom left of the screen to pause play.
"PAUSE" appears in the display, and [**Pause**] button becomes [**Play**].
2. Touch [**Play**] button to resume play.

Selecting a track

Track-up

1. Touch the [**Next**] button to move to the beginning of the next track.
2. Each time you touch the [**Next**] button, the track advances to the beginning of the next track.

Track-down

1. Touch the [**Previous**] button to move back to the beginning of the current track.
2. Touch the [**Previous**] button twice to move back to the beginning of the previous track.

Fast forward/Fast reverse

Fast forward

Touch and hold the [▶▶] button .

Fast reverse

Touch and hold the [◀◀] button .

Repeat play

This function allows you to play the track repeatedly.

Touch the [↺] button to select Repeat one or Repeat all.

Random play

This function allows you to play all tracks in a random order.

Touch the [⌘] button to perform random play.

iPod menu alphabet search

This function searches the subfolders for desired alphabetical letters.

1. Touch the [List] button to show file list.
Touch [Q] button to enter search menu.
2. Input characters by touching buttons on the screen, then touch [Search] to begin searching.
Touch [123] to show digit keypad, touch [ABC] to show letter keypad.
Touch [Space] to input a blank space.
Touch [X] button to delete characters.

Setting iPod simple control mode

Use this function if you wish to operate through your iPod connected to this unit via the USB cable.

Touch the [Options] button, then touch [Simple Control] to set it to [On].

iPod video playback

iPod® / iPhone® video support only available for pre-“lightning” connector.

To playback video from iPod, touch top left corner of the screen, then select a video file to play.

During playback, touch the bottom half of screen to show operation bar.

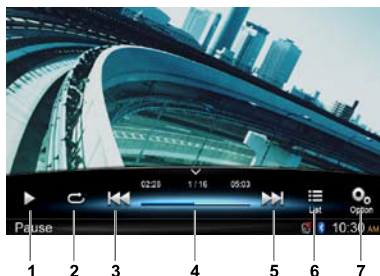

1. Play/Pause
2. Repeat play
3. Previous file
Fast reverse (long press)
4. Progress bar
5. Next file
Fast forward (long press)
6. Show iPod list menu
7. Show other options

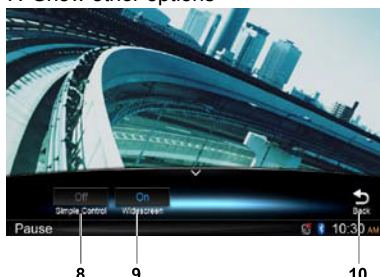

8. Turn on / off Simple Control
9. Turn on Widescreen mode
10. Back to main operation bar

Return to video list menu

Touch [List] button on the operation bar to return to video list menu.

Play videos in wide screen

To play videos in wide screen, touch the [Options] button, then touch [Wide screen] to set it to [On].

13. NAVIGATION (SOLD SEPARATELY)

Note: Further instructions are provided with optional Navigation (SD603AU) sold separately.

Access navigation mode

1. Slide the cover of the card slot located on the bottom left of the panel to the right. Insert a map card into the mini card slot.
 2. To remove the card, you should first select another source or turn off the power, in order to avoid damaging the card. Press to pop it out, then take off the card. Close the cover to the left.
 3. Press [▲] button on panel to visit Navigation mode.
- * The navigation operations depend on your map, it may be different from the following content.

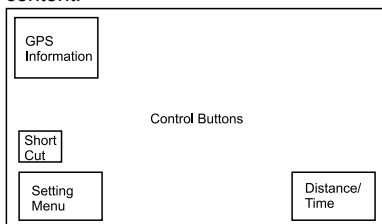

Control buttons

1. Touch top left corner of the screen to show GPS informations. Touch **[Back]** to return.
2. Touch bottom left corner of the screen to enter Navigation menu. Touch **[Show Map]** to return.
3. Touch middle left of the screen to show shortcuts of general functions. Touch [<] button to hide.
4. Touch bottom right corner of the screen to show Distance/Time Left/Arrival Time. Touch it again to hide.
5. Touch the blank area to show control buttons.
 - Top left corner: Plane/three-dimensional
 - Top right corner: Cursor location.
 - [←]/[→]: Move left/right.
 - [↑]/[↓]: Move up/down.
 - [+]/[-]: Enlarge/reduce the map.
 - [Back]**: Hide the buttons.
 - [More]**: Show more informations.
 - [Select]**: Select the route.

14. AUX OPERATIONS

Long press [■ ALL] button to enter main source menu, then select **[AUX 1]** to visit front auxiliary device, and touch **[AUX 2]** to enter rear auxiliary device.

If **[AUX 1]** or **[AUX 2]** is not on the current source menu, touch [-] on the bottom of the screen, then hold the center of screen and drag left/right to show more icons.

15. TROUBLE SHOOTING

GENERAL

Problem	Cause	Measure
Unit can not power on.	Unit fuse blown.	Replace with new fuse of correct rating.
	Car battery fuse blown.	Replace with new fuse of correct rating.
Unit can not power on. Nothing happens when buttons are pressed. Display is not accurate.	The microprocessor has malfunctioned due to noise, etc.	Turn off the power and press the [RESET] button with a thin rod. Note: <i>When the [RESET] button is pressed, turn off the power.*</i> <i>* When the [RESET] button is pressed, frequencies of radio stations, titles, etc. stored in memory are cleared.</i>
Remote control does not work.		Battery depleted.
No/low audio output	Battery installed incorrectly.	Install the battery correctly.
	Improper audio output connection.	Check wiring and correct.
	Volume set too low.	Increase volume level.
	Speakers damaged.	Replace speakers.
	Heavily biased volume balance.	Adjust the channel balance to center position.
Poor sound quality or distortion	Speaker wiring is in contact with metal part of car.	Insulate all speaker wiring connections.
	Non-standard disc used.	Use a standard disc.
	Speaker power rating does not match unit.	Replace speakers.
	Wrong connections.	Check wiring and correct.
Unit resets itself when engine is off.	Speaker is shorted.	Check wiring and correct.
	Incorrect connection between ACC and Battery.	Check wiring and correct.
The display is dark.	The brightness control is too low.	Adjust the brightness properly.
	The operating condition is not good.	The temperature inside the vehicle may be 0°C or lower. Set to an appropriate temperature (25°C or so) and check it again.
	The headlight of the vehicle is lit.	The display is made dark at night to prevent the glare (When the headlight of the vehicle is lit in the daytime, the display gets dark.)
There are red, green, and blue points in display	_____	This is not a failure, but a phenomenon peculiar to a liquid crystal panel (The liquid crystal panel is produced according to technology with very high precision. Note that, though there are effective pixels of 99.99% or more, pixel missing or normally lit pixels account for 0.01%).

DISC Player

Problem	Cause	Measure
Disc cannot be loaded.	Another disc is already loaded.	Eject the disc before loading the new one.
	There is an object installed inside the unit.	Remove the object inside the unit.
Sound skips or is noisy.	Disc is dirty.	Clean the compact disc with a soft cloth.
	Disc is heavily scratched or warped.	Replace with a compact disc with no scratches.
Sound is bad when power is first turned on.	Condensation may form on the internal lens when the car is parked in a humid place.	Let dry for about 1 hour with power on.
Video images are not displayed.	The parking brake is not engaged.	Check that the parking brake is engaged.
Disc cannot play with the display "PARENTAL VIOLATION" shown.	Feature exceeds set parental level.	Release the view limitation or change the parental level. See the subsection "Setting up the parental level."

SD/USB Devices

Problem	Cause	Measure
SD card or USB device cannot be inserted.	The SD card or USB device has been inserted with wrong direction.	Reversing the connection direction of the SD card or USB device, try it again.
	The SD card or USB connector is broken.	Replace with a new card or USB device.
SD card or USB device is not recognized.	The SD card or USB device is damaged.	Disconnect the card or USB device and reconnect. If still not recognized, try replacing with a different card or USB device.
	Connectors are loose.	
Sound skips or is noisy.	MP3/WMA files are not encoded properly.	Use MP3/WMA files encoded properly.
No sound heard with the display "NO FILE" shown.	No MP3/WMA file is stored in the card or USB device.	Store these files properly in the card or USB device.
The video image of iPod/iPhone is disturbed.	The TV Signal setting of the iPod/iPhone is not set correctly.	Set the TV Signal setting (NTSC/PAL) of the iPod/iPhone correctly.

Bluetooth

Problem	Cause	Measure
Cannot pair the Bluetooth enabled device with the car audio system.	The device does not support the profiles required for the system.	Use another device to connect.
	The Bluetooth function of the device is not enabled.	Refer to the user manual of the device for how to enable the function.
The audio quality is poor after connection with a Bluetooth-enabled device.	The internal microphone gain is not set correctly.	Adjust the gain of the internal microphone in System Setup.
	The external microphone is not set correctly nor properly positioned.	Adjust the gain and position of the external microphone. For example, stick the microphone onto the dashboard so it is close to the driver.

16. ERROR DISPLAYS

If an error occurs, one of the following displays is displayed.
Take the measures described below to solve the problem.

Display	Cause	Measure
Disc loading	Disc is being read	Please wait, it may take several minutes for some disc or storage device.
No Disc	Disc is dirty	Clean disc with soft cloth
	Disc is upside down	Insert disc with label side up
	Disc not present in loading compartment	Insert disc
Unsupported Disc	Disc is dirty	Clean disc with soft cloth
	Disc is upside down	Insert disc with label side up
Unknown disc	Disc format is not compatible with this unit	Change another disc.
Region Error	DVD is not compatible with region code of unit	Use discs with corresponding regional code.
Error	Illegal mechanism operation	Press EJECT key for 5 seconds to reset loading mechanism

If an error display other than the ones described above appears, press the **[RESET]** button. If the problem persists, turn off the power and consult your store of purchase.

- * When the **[RESET]** button is pressed, frequencies of radio stations, titles, etc. stored in memory are cleared.

17. SPECIFICATIONS

FM Tuner

Frequency range: 87.5-108.0MHz
 Usable sensitivity: 13dBf
 Frequency response: 30Hz-15kHz
 Stereo separation: >30dB(1kHz)
 Signal/noise ratio: >55dB

AM Tuner

Frequency range: 531-1629kHz
 Usable sensitivity (S/N=20dB): 30dB μ

Disc Player

System: Disc digital audio system
 Frequency response: 20Hz-20kHz
 Signal/noise ratio: >93dB
 Total harmonic distortion: Less than 0.1% (1kHz)
 Channel separation: >60dB
 Video signal output: NTSC
 Video output level: 1 \pm 0.2V

MP3/WMA mode

MP3 sampling rate: 8 kHz to 48 kHz
 MP3 bit rate: 8 kbps to 320 kbps / VBR
 WMA bit rate: 8 kbps to 320 kbps

USB

Specification: USB 1.0/2.0
 Playable audio format:
 MP3(.mp3): MPEG 1/2/Audio Layer-3
 WMA(.wma): Ver 7/8/9.1/9.2
 Playable video format:
 MP4(.mp4): MPEG4part2(Simple)
 MPG(.mpg):MPEG2, MPEG1
 AVI(.avi): MPEG4part2(Simple)
 DivX(.divx): Divx3.11/4.0/5.0/6.0
 Resolution : 720x576
 Audio format :AAC,MP3,PCM,AC3

SD

Memory cards:
 Standard SD/SDHC, micro SD/SDHC
 File system: FAT, FAT16, FAT32
 Playable audio format:
 MP3(.mp3): MPEG 1/2/Audio Layer-3
 WMA(.wma): Ver 7/8/9.1/9.2
 Playable video format:
 M4V(.m4v),MP4(.mp4):
 MPEG4part2(Simple),MPEG4 AVC/
 H.264(Baseline@2.1)
 3GP(.3gp): MPEG4part2(Simple)
 Resolution : 480x272
 Audio format :AAC,AMR,MP3,WMA,WAV

Bluetooth

Specification: Bluetooth Ver. 2.0+EDR
 Profile: HFP (Hands-free Profile)

A2DP (Advanced Audio Distribution Profile)
 AVRCP (AV Remote Control Profile)
 PBAP (Phone Book Access Profile)
 Send/Receive Sensitivity: Class 2

Audio Amplifier

Maximum power output:
 200W (50W x 4)
 Speaker impedance: 4 Ω (4 to 8 Ω allowable)

6.2 Inch TFT LCD

Display resolution (dot): 800RGB (H) x 480(V)
 Active area (mm): 137.52(H) x 77.232 (V)
 Screen size (inch): 6.2 (Diagonal)
 Dot pitch (mm): 0.1719(H) x 0.1609(V)

Input

Audio input sensitivity:
 High: 320mV (at 2V output)
 Mid: 650mV (at 2V output)
 Low: 1.3V (at 2V output)
 (input impedance 10 k Ω or greater)
 AUX-in Audio level : \leq 2V
 Video level : NTSC/PAL 1Vp-p@75 Ω

General

Power supply voltage:
 14.4VDC (10.8 to 15.6V allowable),
 negative ground
 Pre-Amp output voltage:
 4.0V (CD play mode: 1kHz, 0dB, 10k Ω load,
 volume max.)
 Fuse: 15A
 Dimensions of the Main Unit:
 7"(Width) x 4"(Height) x 6.4"(Depth)
 [178(W) x 100(H) x 163(D)mm]
 Weight of the Main Unit: 4.19lb (1.90kg)
 Dimensions of the Remote Control unit:
 1.9"(Width) x 0.5"(Height) x 5.5"(Depth)
 [49(W) x 12(H) x 139(D)mm]
 Weight of the Remote Control Unit:
 1.94oz (55g) (including battery)

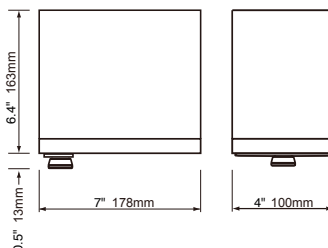

Note:

- Specifications and design are subject to change without notice for further improvement.

18. WIRING AND CONNECTIONS

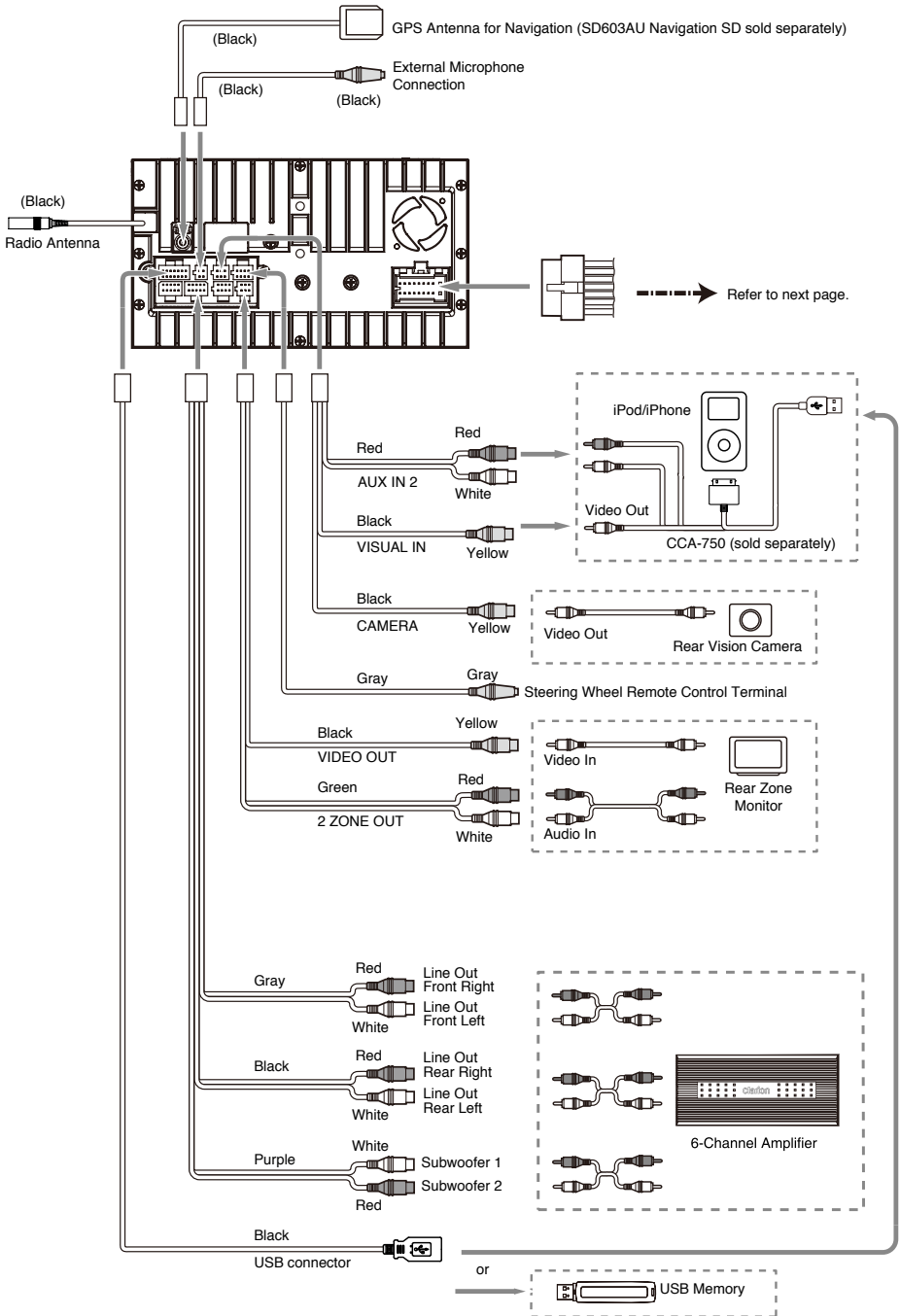

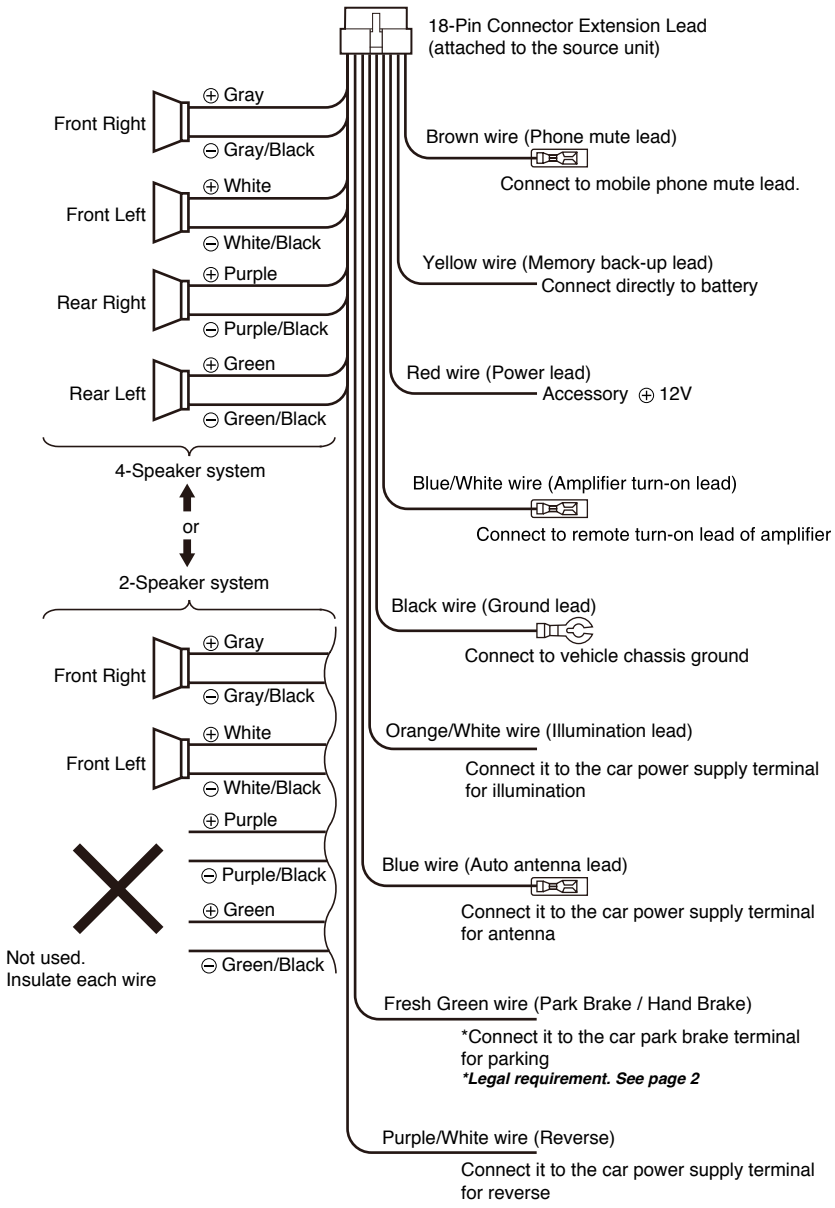

Clarion Co., Ltd.

All Rights Reserved. Copyright © 2013: Clarion Co., Ltd.

Printed in China

P/N 127075005052