

clarion®

Owner's manual & Installation manual
Mode d'emploi et manuel d'installation
Manual de instrucciones y de instalación

CZ2207/CZ2207AU

CD/USB/SD/MP3/WMA RECEIVER
LECTEUR CD/USB/SD/MP3/WMA
RECEPTOR CD/USB/SD/MP3/WMA

CLARION PRODUCT REGISTRATION INFORMATION

For Canada only
www.clarion.com

Dear Customer:
Congratulations on your purchase of a Clarion mobile electronic product. We are confident that you'll enjoy your Clarion experience.
There are many benefits to registering your product. We invite you to visit our website at www.clarion.com to register your Clarion product.
We have made the product registration simple with our easy-to-use website.
The registration form is short and easy to complete. Once you're registered, we can keep you posted on important product information.
Register at www.clarion.com - it's easy to keep your Clarion product up to date.

INFORMATIONS DE L'ENREGISTREMENT DE PRODUITS CLARION

For Canada only
www.clarion.com

Cher(e) client(e):
Nous vous remercions d'avoir acheté ce produit électronique mobile Clarion. Nous sommes convaincus que vous apprécierez votre expérience Clarion.
Il y a beaucoup d'avantages à enregistrer votre produit. Nous vous invitons à visiter notre site Web www.clarion.com pour enregistrer votre produit Clarion.
Nous avons facilité la tâche d'enregistrement de produit simple et facile grâce à notre site Web.
Le formulaire d'enregistrement est court et facile à compléter. Lorsque vous êtes enregistré, nous pouvons vous tenir informés des informations importantes de produits.
Enregistrez à www.clarion.com - c'est facile de mettre à jour votre produit Clarion.

INFORMACIÓN DEL REGISTRO DE PRODUCTO DE CLARION

For Canada only
www.clarion.com

Querido Cliente:
Felicitaciones por su compra de producto electrónico móvil de Clarion. Estamos seguros que usted gozará de su experiencia al registrar su producto de Clarion.
Hay muchas ventajas al registrar su producto. Le invitamos a que visite nuestro sitio en Internet www.clarion.com para registrar su producto Clarion.
Hemos hecho el registro de producto fácil en nuestro sitio. La forma de registro es corta y fácil de completar. Una vez que lo registra, podemos proporcionarle la información de su producto.
Regístrese en www.clarion.com - es fácil mantener su producto Clarion actualizado.

Under Industry Canada Regulations, this radio transmitter may only operate using an antenna of a certain type and maximum (or lesser) gain approved for the transmitter by Industry Canada.
To reduce potential radio interference to other users, the antenna type and its gain should be chosen so that the equivalent isotropically radiated power (e.i.r.p.) is no more than the required one for successful communication.

Contents

Thank you for purchasing this Clarion product:

- Please read this owner's manual in its entirety before operating this equipment.
- After reading this manual, keep it handy, such as in your glove compartment.
- Save your sales receipt. The warranty and your sales receipt are essential for warranty service.

1. FEATURES	3
2. PRECAUTIONS	3
3. CAUTIONS ON HANDLING	3
4. CONTROLS	4
Operation panel	4
Names of buttons and their functions	4
Notes for use of optional remote control	4
Remote control	4
5. OPERATIONS	5
Basic operation	5
System menu	5
Audio menu	5
Radio operation	6
Disc mode operation	6
USB and SD mode operation	7
Aux mode operation	7
Iphone/iPhone mode operation	7
6. TROUBLESHOOTING	8
7. SPECIFICATIONS	8
8. INSTALLATION AND WIRE OPERATION	9

1. FEATURES

- AM/FM Radio
- Front USB port
- MP3/WMA Compatible with ID3-TAG display
- Front 3.5mm AUX input
- 45W x 4 Built-in Amplifier
- IR Remote control
- Compatible with iPod® / iPhone®

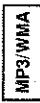

Expanding Systems

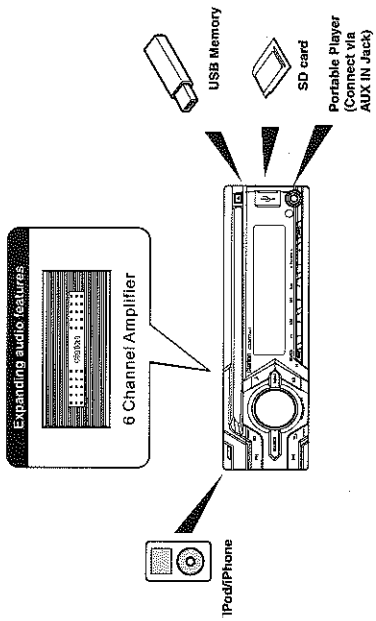

2. PRECAUTIONS



WARNING

For your safety, the driver should not operate the controls while driving. Also, while driving, keep the volume to a level at which external sounds can be heard.

IC Caution.
This device complies with Industry Canada licence exempt RSS standard(s). Operation is subject to the following two conditions:
(1) This device may not cause interference, and
(2) This device must accept any interference, including interference that may cause undesired operation of the device.



3 CAUTIONS ON HANDLING

Protect from high temperature. Expose to direct sunlight for an extended period of time can produce very high temperature in your vehicle. Cool down the interior before starting the playback.

4 CONTROLS

Operational Panel

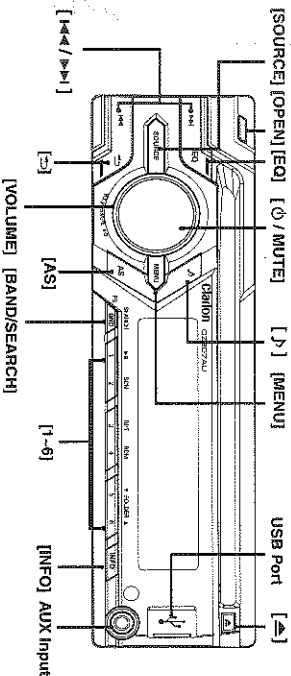

Names of Buttons and their Functions

- **[SOURCE] Button**
 - Press **SOURCE** button to toggle the audio source
- **[OPEN] Button**
 - Unlock the front panel
- **[EQ] Button**
 - Press this button to the the preset equalizer setting:
FLAT->JAZZ->POP CLASSIC->ROCK->NEWS->URBAN->RAVE->MOVIE->TECHNO USER
- **[Φ / MUTE] Button**
 - Press this button to turn power On or Off. (long press).
- **[▶] Button**
 - Press to adjust the sound effect setting:
EQ->XBS(XBass)->SUB(Subwoofer)->BAL(balance)->FAD(fader)
- **[MENU] Button**
 - Press access into the system menu mode.
- **[▲] Button**
 - Press to eject disc

- **[◀/▶/▶▶] Button**
 - Use these buttons for tuning up and down in Tuner mode, Disc mode, SD mode and USB mode.
 - Press and hold to Fast Forward/Backward in Disc mode, SD mode and USB mode.

- **[↔] Button**
 - Press this button to quick return to previous menu or mode.

- **[VOLUME] Button**
 - Rotate to adjust the volume level.

- **[AS/PS] Button (radio mode)**
 - Auto Store / Presser scan
 - Press and hold enter auto memory store mode

Notes for use of Remote Control

1. Aim the remote control at the remote sensor on the unit.
2. Remove the battery from the remote control or insert a battery insulator if the battery has not been used for a month or longer.
3. DO NOT store the remote control under direct sunlight or in high temperature environment, or it may not function properly.
4. Use "button shaped" lithium battery "CR2025"
5. DO NOT subject battery to recharge, disassemble, heat or dispose in fire or water.
6. Insert the battery in proper direction according to the (+) and (-) polarities.
7. Store the battery in a place where children cannot reach to avoid the risk of accident.

- **[BAND/SEARCH] Button**
 - Press to select tuner band in Tuner mode.
 - Press to activate the MP3 file searching mode, then use the volume to select / search by the number in USB and SD mode.

[1-6] Buttons

- **[1] Button:** Play / Pause / Preset station 1
- **[2] Button:** Scan play / Preset station 2
- **[3] Button:** Repeat play / Preset station 3
- **[4] Button:** Random play / Preset station 4
- **[5] Button:** Previous folder / Preset station 5
- **[6] Button:** Next folder / Preset station 6

[INFO] Button

- Press to view the Clock
- Press to change the display indication.





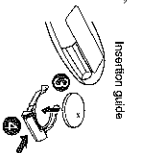

Inserting the Battery

1. Slide remote control units rear cover in the direction shown.
2. Insert battery (CR2025) into insertion guides with printed side (+) up.
3. Press battery into compartment as shown.
4. Replace and slide cover until it clicks into place.



Insertion guide

Remote Control

- [] Button
 - Mute or Unmute the audio output
- [] [] Button
 - Press  button to increase the volume.
 - Press  button to decrease the volume.
- [] [] Button
 - Preset station up/down
 - Previous / next track
 - Press and hold for Fast Forward / Backward
- [SRC] Button
 - Toggle the audio source

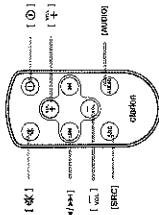

5. OPERATIONS

Basic Operation

Note: Be sure to read this chapter referring to the chapter "4.CONTROLS"

CAUTION

When the unit is turned on, starting and stopping the engine with its volume raised to the maximum level it may cause hearing damage. Be careful about adjusting the volume.

Power On/Off

Note:

- Start this engine before using this unit.
- Be careful about using this unit for a long time without running the engine. If you drain the vehicle battery too far, you may not be able to start the engine and this can reduce the service life of the battery.



Adjusting the volume

- Rotating the [VOLUME] to increase/decrease the volume.
The adjustable range of volume is 0 to 46.

Mute

Press the [MUTE] button to turn the mute On and Off.

System Menu

In any mode, press [MENU] button to enter System Menu. Press [] or [] button to select options, rotate the [VOLUME] knob to adjust a value / option.

CLOCK

Rotate the [VOLUME] knob to set the hour, press the [MUTE] button to confirm, and then rotate the [VOLUME] knob to set the minutes.

12/24H

Rotate the [VOLUME] knob to choose time format: 12 or 24 hours.

BEEP ON/OFF



Rotate the [VOLUME] knob to choose button Beep sound On or Off.

DX / LO (radio mode)

Rotate the [VOLUME] knob to choose radio Local or distant at RADIO mode.

- LO:** Only stations with strong signal can be received.
- DX:** Stations with strong and weak signals can be received.

Audio Menu

Press [] button to enter sound effect setting mode. Press [] or [] button to select options, rotate the [VOLUME] knob to adjust a value / option.

EQ (Preset Equalizer Setting)

Rotate the [VOLUME] knob to change EQ:
Flat->Jazz->Pop->Classic->Rock->News->Urban->Rave->Movie->Techno->User

Display System Information
Press the [INFO] button on the front panel to switch the display information, system time and playing source.

DIMMER

Rotate the [VOLUME] knob to choose the Dimmer On or Off.

- ON:** LCD dimmer is active when small light of vehicle is turned ON.
- OFF:** LCD always maximum brightness regardless of the vehicle small light.

TUNE AREA (radio mode)

Rotate the [VOLUME] knob to select suitable country region:

- U.S.A (United States)
- LATIN (Latin America)
- EUROPE (Eastern/Western Europe)
- ASIA (Asia Pacific)

DEFAULT VOL

Rotate the [VOLUME] knob to adjust the default volume.

When the [USER] is appear, press the [MUTE] button to enter into below option and rotate the [VOLUME] knob to adjust a value:

- BASS(bass): range -7 to +7
- MID(middle): range -7 to +7
- TREB (treble): range -7 to +7

XBS On/Off
Rotate the [VOLUME] knob to turn On or Off the X-BASS booster function.

SUB On/Off
Rotate the [VOLUME] knob to select subwoofer between ON and Off.

SUB LPF (SUB ON)

Rotate [VOLUME] knob to adjust the subwoofer Low Pass Filter range: 80Hz/120Hz/160Hz

SUB GAIN (SUB ON)
Rotate the [VOLUME] knob to adjust the subwoofer gain range: 0 to 12

BAL (Balance)
Rotate the [VOLUME] knob to adjust the balance between the right and left speakers from 12R (full right) to 12L (full left).

FAD (Fader)
Rotate the [VOLUME] knob to adjust the fader between the front and rear speakers from 12R (full rear) to 12F (full front).

Radio Operation

Select Radio as Playing Source
Press the [SOURCE] button to select the RADIO mode.

Selecting the Radio Band
Press the [BAND / SEARCH] button on the front panel to select one Radio band among F1, F2, F3, AM.

[>P] / Tuning Up / [<P] / Tuning Down Buttons

1. Press the [>P] / [<P] button to seek to the next strongest station.
2. Press and hold the [>P] / [<P] button to change frequency step by step.

Preset Scan

Preset scan receives the stations stored in preset memory in order. This function is useful when searching for a desired station in memory.

1. Press the [ASPS] button.
2. When a desired station is tuned in, press the [ASPS] button again to continue receiving that station.

Auto Store

Auto stations with sufficient signal strength will be detected and stored in the memory.

Press and hold the [ASPS] button to start automatically select six strong stations and store them into six presets. The new stations replace any stations already stored in the band.

Manual Store
When one expected radio station has been detected, press and hold number button 1-6 to store it in the memory.

Recall the Stored Stations
Press one numeric button among 1 to 6 on the front panel to select the corresponding stored stations.

Local Seeking
When LOCAL seeking is ON, only those radio stations with strong radio signal could be received.

To select LOCAL function, press the [MENU] button on the front panel, then press the [>P] / [<P] button repeatedly until LO or DX display on the LCD, rotate the [VOLUME] knob to select local or distant mode.

Area Set

This option allows you to select the appropriate frequency spacing for your area.

1. Press the [MENU] button.
2. Press the [>P] / [<P] button to select AREA *
3. Rotate the [VOLUME] knob to select: "U.S.A.", "LATIN", "EUROPE", "ASIA"
4. Press the [MUTE] button to confirm.

Disc Mode Operation

Insert a Disc

Insert the disc into the Disc Slot with label side facing up; the unit will play starts automatically.

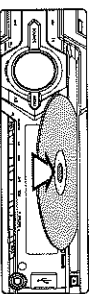

Eject Function

Press the [EJECT] button front panel to take out the disc. When the Disc is ejected, the unit switches to the previous source, if still connected. Otherwise, the unit switches to radio mode automatically.

Selecting a Track

1. Press the [>P] button to advance to the next track/song.
2. Press the [<P] button to go to previous track/song.
3. Press and Hold in the [>P] button to fast forward through the track/song.
4. Press and Hold in the [<P] button to fast backward through the track/song.

Play / Pause

Press the [▶/⏸] button to pause the track/song that is currently playing.
Press the [▶] button to resume playing the track/song that has been paused.

Folder Select

This function allows you to select a folder containing MP3/WMA files and start playing from the first track in the folder.
Press the [◀ 5 / ▶ 6] button to select a folder.

Search Function

1. Press the [BAND / SEARCH] button on front panel access the MP3 / WMA file search mode.
2. Rotate the [VOLUME] knob to search through all folders on the device then press [◊ / MUTE] to make your selection.
3. Rotate the [VOLUME] knob to select the desired track within the previously selected folder and press [◊ / MUTE] to start playing.

Display Function

During playback, pressing the [INFO] button will automatically cycle through the following information on the file being played on the LCD:
FOLDER NAME->FILE NAME->TITLE->ARTIST->ALBUM

Top function

The top function resets the CD player to the first track of the disc. Press the [1] button (long press) to play the first track (track No. 1) on the disc.

USB and SD Mode Operation

Insert the USB device

- Slide the USB socket cover **USB** to left.
- Insert the USB device into the USB socket.
- Press the **[SOURCE]** button to select **USB / IPOD** mode to start playing.
- To remove the USB device, you should first select another source or turn off the power, in order to avoid damaging the USB device.

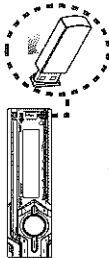

Insert the SD Card

- Press the **[OPEN]** button to unlock the front panel.
- Hold the left hand side of the panel & pull forward to disengage it from the chassis.
- Insert the SD Card into the slot with label facing left until a "CLICK" sound is heard.
- Replace the front panel and press the **[SOURCE]** button to select SD mode to start playing.



- Press and hold in the **[>>>]** button to fast forward through the track/song.
- Press and hold in the **[<<<]** button to fast backward through the track/song.

Play / Pause
Press the **[>>>]** button to pause the track/song that is currently playing.
Press the **[>>>]** button to resume playing the track/song that has been paused.

Folder Select
This function allows you to select a folder containing MP3/WMA files and start playing from the first track in the folder.
Press the **[<>]** button to select a folder.

Search Function

- Press the **[BAND / SEARCH]** button on front panel, access the MP3 /WMA file search mode.
- Rotate the **[VOLUME]** knob to search through all folders on the device then press **[< / MUTE]** to make your selection.
- Rotate the **[VOLUME]** knob to select the desired track within the previously selected folder and press **[< / MUTE]** to start playing.

Display Function

During playback, pressing the **[INFO]** button will automatically cycle through the following information on the file being played on the LCD:
FOLDER NAME->FILE NAME->TITLE->ARTIST->ALBUM

Top function

The top function resets the USD and SD player to the first track of the device. Press the **[1]** button (long press) to play the first track (track No. 1) on the USB or SD mode.

AUX Mode Operation

Press the **[SOURCE]** button on the front panel to select "AUX IN".
AUX IN is just for audio content with 3.5mm Jack connector, plugged into audio-in socket on the front panel.

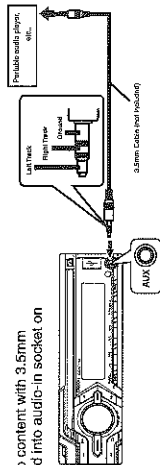

iPod/iPhone Mode Operation

Connect

Connect an iPod/iPhone to the USB socket on front panel. When connecting a device, press the **[SOURCE]** button to select USB/iPod mode to start playing. The track information displays on the screen once playback start.

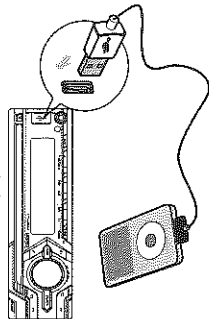

Compatible iPod/iPhone

You can connect the following iPod/iPhone:

iPod/iPhone Control Music Playback Mode

- Press and hold the **[< / >]** button on front panel to switch between the two control modes:
- iPod control mode:** Use the iPod/iPhone to operate the music control.
- Unit control mode:** Use the head unit to operate the music control.

Note:

Please make sure the iPod/iPhone cable is connected correctly. And please only use original iPod/iPhone cable.

Selecting a Track

- Press the **[>>>]** button to advance to the next track/song.
- Press the **[<<<]** button to go to previous track/song.
- Press and hold the **[>>>]** button to fast forward through the track/song.
- Press and hold the **[<<<]** button to fast backward through the track/song.

Play / Pause

Press the **[>>>]** button to pause the track/song that is currently playing.
Press the **[>>>]** button to resume playing the track/song that has been paused.

iPod Menu Alphabet Search

This function searches the subfolders for desired alphabetical letters.

- Press the **[BAND/SEARCH]** button to select the iPod menu mode.
- Rotate the **[VOLUME]** knob to switch between categories.
- PLAYLISTS, ARTIST, ALBUM, SONGS, GENRE, COMPOSER, AUDIOBOOK**
- Press **[< / MUTE]** button to confirm selection.
- Press the **[AS/PS]** button (3 seg.)
- Rotate the **[VOLUME]** knob to select the desired letter to search.
- Press the **[< / MUTE]** button to confirm (On that moment the LCD show SEARCH)
- Rotate the **[VOLUME]** knob to choose the desired song to hear.
- Press the **[< / MUTE]** button to confirm selection and then you will hear the chosen song.

Display Function

During playback, pressing the **[INFO]** button will automatically cycle through the following information on the file being played on the LCD:
ALBUM -> SONGS -> ARTIST -> CLOCK

6. TROUBLESHOOTING

General

Problem	Cause	Measure
Unit cannot power on.	Unit fuse blown. Car battery fuse blown.	Replace with new fuse of correct rating. Replace with new fuse of correct rating.
No/low audio output.	Improper audio output connection. Volume set too low. Speakers damaged.	Check wiring and correct. Increase volume level. Replace speakers.
Poor sound or distortion.	Heavily biased volume balance. Speaker wiring is in contact with metal part of car. Speaker match unit.	Adjust the channel balance to center position. Insulate all speaker wiring connections. Replace speakers.
Unit resets itself when engine is off.	Incorrect connection between ACC and Battery.	Check wiring and correct. Check the wiring and correct.

Disc Player

Problem	Cause	Measure
Disc cannot be loaded.	Another disc is already loaded. There is an object inserted on the unit.	Eject the disc before loading the new one. Remove the object inside the unit.
Sound skips or is noisy.	Compact disc is dirty. Compact disc is heavily scratched or warped.	Clean the compact disc with a soft cloth. Replace with a compact disc with no scratches.
Sound is bad when power is first turned on.	Condensation may form on the internal lens when the car is parked in a humid place.	Let dry for about 1 hour with power on.

USB

Problem	Cause	Measure
USB device cannot be inserted.	The USB device has been inserted with wrong direction. The USB connector is broken.	Reversing the connection direction of the USB device, try it again. Replace with a new USB device.
USB device is not recognized.	The USB device is damaged. Connections are loose.	Disconnect the USB device and reconnect, if the device is still not recognized, try replacing with a different USB device.
No sound heard with USB device.	No MP3/WMA file is stored in the USB device.	Store these files properly in the USB device.
Sound skips or is noisy.	MP3/WMA files are not encoded properly.	Use MP3/WMA files encoded properly.

7. SPECIFICATIONS

FM Tuner

Australia:	AM 522-1620kHz
	FM 87.5-108.0MHz
Asia:	AM 522-1620kHz
	FM 87.5-108.0MHz
Canada:	AM 530-1710kHz
	FM 87.5-107.90MHz
U.S.A.:	AM 530-1710kHz
	FM 87.5-107.9MHz

CD/MP3/WMA mode

Disc Player System: Disc digital audio system
MP3 sampling rate: 32kHz, 44.1kHz, 48kHz
MP3 bit rate: 8-320kbps and variable bit rate

WMA bit rate:	8-320kbps
Logical format:	ISO9660, Joliet
Number of file:	Maximum 999
Max directory	10
Origin:	Tree sorting
Sorting Method:	64Byte
Max File/Directory Name:	64Byte
ID3 tag:	V2.0 or later

USB

USB Host:	Host 1.1 compatibles 2.0
Maximum memory capacity:	32GB
Playable folders:	up to 99
Playable files:	up to 3000

SD

Maximum memory capacity:	32GB
Playable folders:	up to 99
Playable files:	up to 3000

General

Power Supply Voltage:	12V DC (10.8 to 15.6V), Negative Ground
Fuse:	15A
Speaker Impedance:	4-8 ohms per channel
Power output:	45W x 4 channels
Aux-In level:	2650mV

Note: Specifications and design are subject to change without notice for further improvement.

8. INSTALLATION AND WIRE CONNECTION

1. Before Starting

1. This set is exclusively for use in vehicles with a negative ground 12 V power supply.
2. Read these instructions carefully.
3. Be sure to disconnect the battery ⁺ terminal before starting. This is to prevent short circuits during installation. (Figure 1)

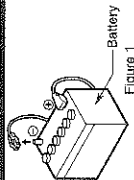

2. General Cautions

1. Do not open the case. There are no user serviceable parts inside. If you drop anything into the unit during installation, consult your dealer or an authorized Clarion service center.
2. Use a soft, dry cloth to clean the case. Never use a rough cloth, thinner, benzine, or alcohol etc. For tough dirt, apply a little cold or warm water to a soft cloth and wipe off the dirt gently.

3. Cautions on Installation

1. Prepare all articles necessary for installing the source unit before starting.
2. Install the unit within 30° of the horizontal plane. (Figure 2)
3. If you have to do any work on the car body, such as drilling holes, consult your car dealer beforehand.

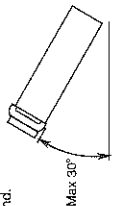

Figure 2

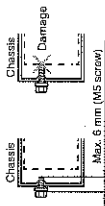

Figure 3

4. Installation the Source Unit

1. Place the mounting bracket into the instrument panel, use a screwdriver to bend each stopper of the mounting bracket inward, then secure the stopper.
2. Wire as shown in Section 5.
3. Insert the source unit into the mounting bracket until it locks.
4. Take care of the top and bottom of the trim ring and mount it so that all the hooks are locked.

Note: 1. Some car models require special mounting kits for proper installation. Consult your

1. Clarion dealer for details.
2. Fasten the front stopper securely to prevent the source unit from coming loose.

Notes of installation:

- Before installation, please make sure proper connections are conducted and the unit operates normally. Improper connection may result in damage to the unit.
- Use only accessories designed and manufactured for this unit and other unauthorized accessories may result in damage to the unit.
- Before installation, please fasten all power cables.
- DO NOT install the unit in the place where close to hot area to prevent damage to electrical components such as the laser head.
- Install the unit horizontally. Installing the unit more than 30 degree vertically may result in worse performance.
- To prevent electric spark, connect the positive pole first and then the negative pole.

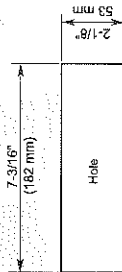

53 mm
2-1/8"

Hole

Unit Installation

Method A

1. Insert mounting bracket into dash board, choose appropriate mounting tab according to the gap width, bending the mounting tab outwards with a screwdriver to fix the mounting bracket in place.
2. Slide the unit into the bracket until you hear a click sound.

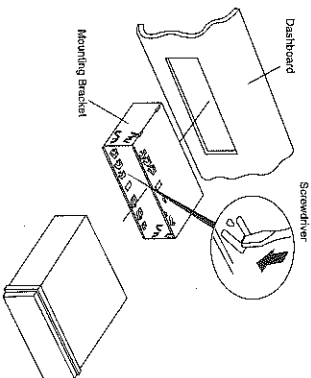

Method B

1. Insert this unit directly to the opening of the
2. Place MSX7 cylindrical screw through the poles of the illumination frame located inside the opening to hold the unit and fasten the screws to left & right.

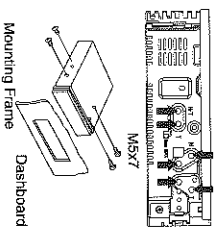

Trim ring installation

Attach the trim ring around the front panel. Take care of the top and bottom of the trim ring and mount it so that all the hooks are locked.

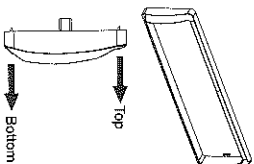

5. Wiring and Connections

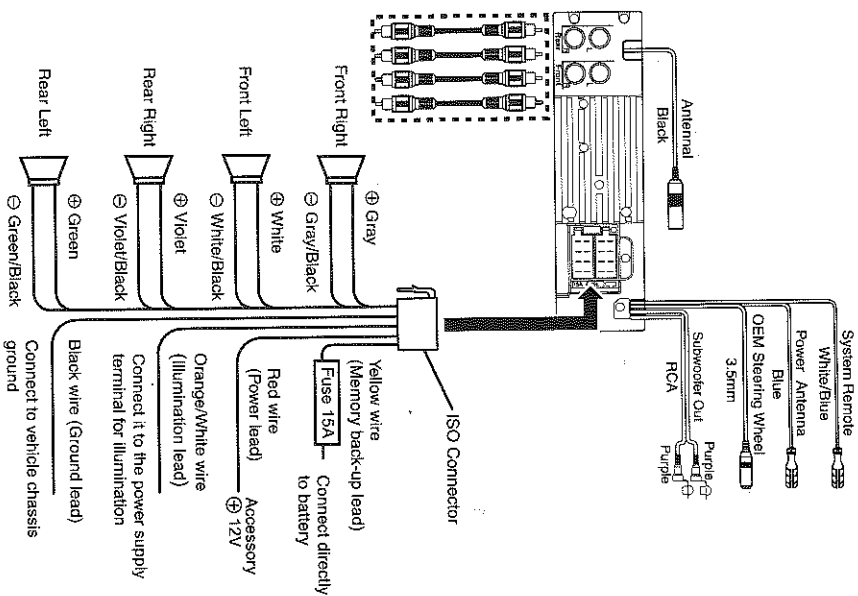

Clarion Co., Ltd.

Copyright © 2017 Clarion Co., Ltd.

Printed in China / Imprimé en Chine / Impreso en China



PN:

015/03