

clarion®

Owner's manual

NX404AU

**DVD MULTIMEDIA STATION WITH BUILT-IN
NAVIGATION & 6.2" TOUCH PANEL CONTROL**

1. FEATURES.....	3
Expanding Systems	3
2. PRECAUTIONS.....	4
3. CAUTIONS ON HANDLING.....	6
Operation Panel	6
USB Port	6
Cleaning	6
Handling Discs.....	7
4. OPERATIONAL PANEL	9
Functions of Buttons.....	9
5. REMOTE CONTROL(OPTIONAL).....	10
Remote Control Function	11
6. MAIN MENU.....	13
7. DVD VIDEO PLAYER OPERATIONS	14
Discs	14
Change DVD System Settings	15
Watching to a Disc.....	15
Operate the DVD Player Menu.....	16
Operate the Video files Player Menu	18
Switching Subtitles	18
Video Files List.....	18
Play DivX Video-On-Demand File	18
Playable Disc Video Formats.....	19
8. CD PLAYER OPERATIONS.....	20
Listening to a Disc/Ejecting a Disc	20
Showing CD Player Mode Screen	20
Operate the CD Player Menu.....	20
Listening to Compressed Audio	21
Tag Display Function	21
9. USB AUDIO OPERATIONS	23
Notes on Using USB Memories.....	23
Select USB Audio Mode.....	23
Playing Audio Files in USB Memory	24
10. USB VIDEO OPERATIONS.....	25
Notes on Using USB Memories.....	25
Select USB Video Mode	25
Playing Video Files in USB Memory	25
Playable Video Formats.....	25
11. iPod OPERATIONS.....	27
Notes on using Apple iPod/iPhone.....	27
iPod Audio ID3 Info.....	27
iPod Audio Playlist Mode Screen	28
iPod Video ID3 Mode Screen.....	30
iPod Video List Mode Screen	30
iPod Video Simple Control Mode Screen	31
iPod Video Play Mode Screen	31
iPod Audio Bluetooth Mode.....	31
12. Pandora® OPERATIONS.....	32
Selecting the Pandora Mode	32
Pandora Bluetooth Mode.....	33
13. Bluetooth® AUDIO PLAYER OPERATIONS	34
Selecting the Bluetooth Audio Mode	34
Bluetooth Audio Player Settings	34

Registering your Bluetooth audio player (Pairing).....	34
Selecting the Bluetooth Audio Player	35
Controlling the Bluetooth Audio Player.....	35
14. Bluetooth® TELEPHONE OPERATIONS.....	36
Select the BT Phone Mode.....	36
Bluetooth Telephone Settings	36
Registering Your Cellular Phone (Pairing).....	37
Select the Cellular Phone.....	37
Obtaining the Phone Book Data	37
Telephone Operations	37
15. TUNER OPERATIONS.....	39
16. TV OPERATIONS	40
17. DAB OPERATIONS.....	41
18. HDMI MODE	43
Select HDMI source	44
This HDMI mode is only indicate the screen of the iPhone, Android. Can't operate by the touch screen of NX404AU	44
19. AUX	45
20. CAMERA INPUT OPERATIONS	45
21. REAR SOURCE OPERATIONS.....	46
DVD Video in Rear	46
DVD Video Rear Source Control Information Mode.	46
DVD Video Rear Source Control Direct Mode.	46
iPod Video in Rear	47
iPod Video Rear Source Control Play Mode.....	47
iPod Video Rear Source ID3 Mode.....	47
TV in Rear	47
22. SETTING OPERATIONS.....	48
General Setup Menu	48
Video Setup Menu	48
Audio Setup Menu	49
Navigation Setup Menu	49
Others Setup Menu.....	49
Set the Anti-Theft code.....	50
23. TROUBLESHOOTING	51
GENERAL.....	51
DVD PLAYER.....	51
USB DEVICE	52
Bluetooth	52
TFT screen	53
24. ERROR DISPLAY.....	54
DVD PLAYER.....	54
25. SPECIFICATIONS.....	55
26. WIRE CONNECTION GUIDE.....	57

1. FEATURES

- **FLAC**(Free Lossless Audio Codec)
- **Built-in Bluetooth® Handsfree (HFP) and Audio Streaming (A2DP & AVRCP)**
- **Front-Panel Auxiliary Input and 6ch RCA Output with Subwoofer Control**

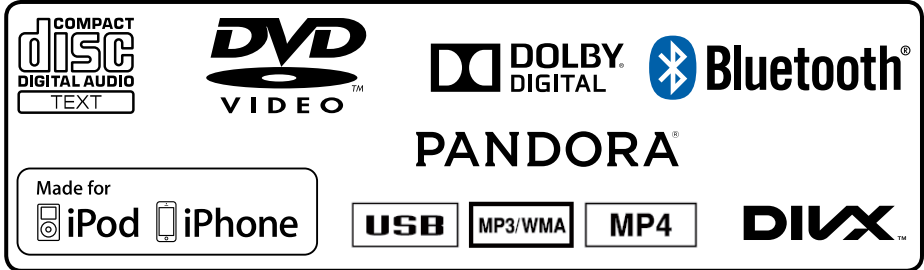

Expanding Systems

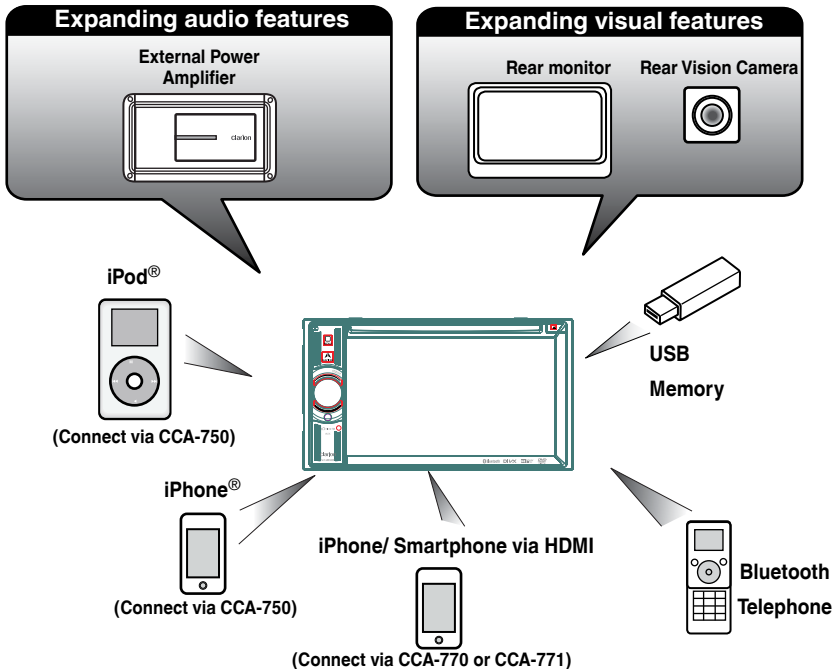

NOTE:

- The items listed outside of the frames are the commercial products generally sold.
- CCA-750, CCA-770, CCA-771: Sold separately.

2. PRECAUTIONS

WARNING

- For your safety, the driver should not watch any video sources and/or operate the controls while driving. Please note that watching and operating any video sources while driving are prohibited by law in some countries. Also, while driving, keep the volume to a level at which external sounds can be heard.
- Do not disassemble or modify this unit. It may cause an accident, fire, or electric shock.
- Do not use this unit when a trouble exists, such as no screen content appears or no sound is audible. It may cause an accident, fire, or electric shock. For that case, consult your authorized dealer or a nearest Clarion service center.
- In case of a problem, such as any material has been entered in the unit, the unit gets wet, or smoke or strange smells come out of the unit, etc., stop using this unit immediately, and consult your authorized dealer or a nearest Clarion service center.
Using it in that condition may cause an accident, fire, or electric shock.
- Use a fuse with the same specification only when replacing the fuse.
Using a fuse with a different specification may cause a fire.
- For the installation of this unit or a change in the installation, ask your authorized dealer or a nearest Clarion service center for safety. Professional skills and experiences are required to do so.
- This navigation system should not be used to replace your own judgment. No itinerary suggested by this navigation system should ever override any highway regulations, your own judgment, or a knowledge of safe driving practices. Do not follow the navigation system's suggested itinerary if it would cause you to perform a dangerous or illegal act, place you in a dangerous situation, or take you into an area you consider unsafe.
- The advice provided by the navigation system is to be regarded as a suggestion only. There may be times when the navigation system displays the vehicle's location incorrectly, fails to suggest the shortest route, or fails to direct you to your desired destination. In such instances, rely on your own driving judgment, taking into account the driving conditions at the time.
- Do not use the navigation system to locate emergency services. The database does not contain a complete listing of emergency services such as police stations, fire halls, hospitals and walk-in clinics. Please show discretion and ask for directions in such instances.
- As the driver, you alone are responsible for your driving safety.
- In order to avoid a traffic accident, do not operate the system while driving.
- In order to avoid a traffic accident, operate the system only when the vehicle is stopped at a safe place and the parking brake is on.
- In order to avoid a traffic accident or traffic offense, remember that actual road conditions and traffic regulations take precedence over the information contained on the navigation system.
- The software may contain inaccurate or incomplete information due to the passage of time, changing circumstances, and the sources of information used. Please respect current traffic conditions and regulations at all times while driving.
- Where actual road conditions and highway regulations differ from the information contained on the navigation system, abide by the highway regulations.
- Keep the amount of time spent viewing the screen while driving to a strict minimum.
- The navigation system does not provide, nor represent in any way information on: traffic and highway regulations; technical aspects of the vehicle including weight, height, width, load and speed limits; road conditions including grade, percentage of incline and surface conditions; obstacles such as the height and width of bridges and tunnels; and other current driving or road conditions. Always rely on your own judgment when driving a car, taking into account current driving conditions.

"Clarion reminds the customers that the use of mobile smartphones whilst driving or stationery in a motor vehicle is against Australian Road Laws".

1. When the inside of the car is very cold and the player is used soon after switching on the heater, moisture may form on the disc (DVD/CD) or the optical parts of the player and proper playback may not be possible. If moisture forms on the disc (DVD/CD), wipe it off with a soft cloth. If moisture forms on the optical parts of the player, do not use the player for about one hour. The condensation will disappear naturally allowing normal operation.

2. Driving on extremely bumpy roads which cause severe vibration may cause the sound to skip.

3. This unit uses a precision mechanism. Even in the event that trouble arises, never open the case, disassemble the unit, or lubricate the rotating parts.

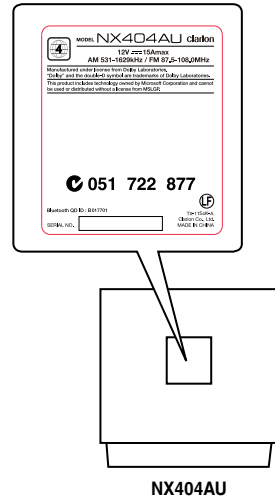

3. CAUTIONS ON HANDLING

Operation Panel

For a longer service life, be sure to read the following cautions.

- The operation panel will operate properly in a temperature range of 0° to 60° C.
- Do not allow any liquids on the set from drinks, umbrellas etc. Doing so may damage the internal circuitry.
- Do not disassemble or modify the set in any way. Doing so may result in damage.
- Subjecting the operation panel to shocks may result in breakage, deformation or other damage.
- Do not let cigarettes burn the display.
- If a problem should occur, have the set inspected at your store of purchase.
- The remote control unit may not work if the remote control sensor is exposed to direct sunlight.
- *Remote control unit is sold separately.
- In extremely cold weather, the display movement may slow down and the display may darken, but this is not a malfunction. The display will work normally when the temperature increases.
- Small black and shiny spots inside the liquid crystal panel are normal for LCD products.

USB Port

- The USB memory sticks must be recognized as "USB mass storage class" to work properly. Some models may not operate correctly.
- When the memorized data is lost or damaged by any chance, Clarion shall not be liable for any damage.**
- When using an USB memory stick, we recommend that you backup your data stored on it before by using a personal computer etc.
- Data files may be broken when using USB memory sticks in the following situation: When disconnecting the USB memory stick or turning the power off during writing or reading data. When affected by static electricity or electric noise. Connect/disconnect the USB memory stick when it is not accessed.
- Connecting with the computer is not covered.

Cleaning

• Cleaning the cabinet

Use a soft, dry cloth and gently wipe off the dirt. For tough dirt, apply some neutral detergent diluted in water to a soft cloth, wipe off the dirt gently, then wipe again with a dry cloth.

Do not use benzene, thinner, car cleaner, etc., as these substances may damage the cabinet or cause the paint to peel. Also, leaving rubber or plastic products in contact with the cabinet

for long periods of time may cause stains.

• Cleaning the liquid crystal panel

The liquid crystal panel tends to collect dust, so wipe it off occasionally with a soft cloth. The surface is easily scratched, so do not rub it with hard objects.

Handling Discs

Handling

- New discs may have some roughness around the edges. If such discs are used, the player may not work or the sound may skip. Use a ball-point pen or the like to remove any roughness from the edge of the disc.

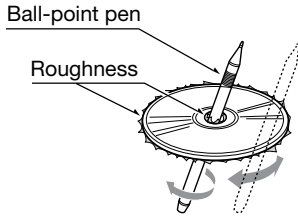

Never stick labels on the surface of the disc or mark the surface with a pencil or pen.

- Never play a disc with any cellophane tape or other glue on it or with peeling off marks. If you try to play such a disc, you may not be able to get it back out of the DVD player or it may damage the DVD player.
- Do not use discs that have large scratches, are misshapen, cracked, etc. Use of such discs may cause misoperation or damage.
- To remove a disc from its storage case, press down on the center of the case and lift the disc out, holding it carefully by the edges.
- Do not use commercially available disc protection sheets or discs equipped with stabilizers, etc. These may damage the disc or cause breakdown of the internal mechanism.

Storage

- Do not expose discs to direct sunlight or any heat source.
- Do not expose discs to excess humidity or dust.
- Do not expose discs to direct heat from heaters.

Cleaning

- To remove fingermarks and dust, use a soft cloth and wipe in a straight line from the center of the disc to the circumference.
- Do not use any solvents, such as commercially available cleaners, anti-static spray, or thinner to clean discs.
- After using special disc cleaner, let the disc dry off well before playing it.

On Discs

- Never turn off the power and remove the unit from the car with a disc loaded.

CAUTION

For your safety, the driver should not insert or eject a disc, opening the operation panel while driving.

About the registered marks, etc.

- This product incorporates copyright protection technology that is protected by U.S. patents and other intellectual property rights. Use of this copyright protection technology must be authorized by Rovi Corporation, and is intended for home and other limited viewing uses only unless otherwise authorized by Rovi Corporation.
- Manufactured under license from Dolby Laboratories. "Dolby" and the double-D symbol are trademarks of Dolby Laboratories.
- "Made for iPod" and "Made for iPhone" mean that an electronic accessory has been designed to connect specifically to iPod or iPhone respectively, and has been certified by the developer to meet Apple performance standards. Apple is not responsible for the operation of this device or its compliance with safety and regulatory standards. Please note that the use of this accessory with iPod or iPhone may affect wireless performance. iPhone, iPod, iPod nano, and iPod touch are trademarks of Apple Inc., registered in the U.S. and other countries. Lightning is a trademark of Apple Inc.
- The Bluetooth® word mark and logos are registered trademarks owned by the Bluetooth® SIG, Inc. And any use of such marks by Clarion Co.,Ltd. is under license. Other trademarks and trade names are those of their respective owners.
- Pandora. the Pandora logo. and the Pandora trade dress are trademarks or registered trademarks of Pandora Media. Inc. used with permission.
- DivX®, DivX Certified® and associated logos are trademarks of Rovi Corporation or its subsidiaries and are used under license. DivX Certified® to play DivX® video, including premium content. Covered by one or more of the following U.S. patents: 7,295,673; 7,460,668; 7,515,710; 7,519,274
ABOUT DivX VIDEO: DivX® is a digital video format created by DivX, LLC, a subsidiary of Rovi Corporation.
This is an official DivX Certified® device that has passed rigorous testing to verify that it plays DivX video. Visit divx.com for more information and software tools to convert your files into DivX videos.
ABOUT DivX VIDEO-ON-DEMAND: This DivX Certified® device must be registered in order to play purchased DivX Video-on-Demand (VOD) movies. To obtain your registration code, locate the DivX VOD section in your device setup menu. Go to vod.divx.com for more information on how to complete your registration.

4. OPERATIONAL PANEL

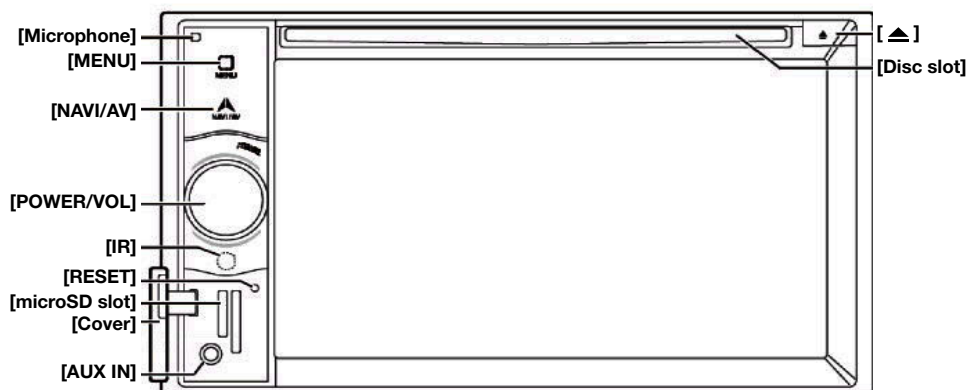

Functions of Buttons

[POWER/VOL] Knob

- Press this knob to turn on the power.
- When the power is already on, it moves to the Navigation mode. If Navigation mode is displayed, it moves to the Navigation menu.
- Keep pressing this knob more than 2 second to turn off the power.
- Turn this knob to left or right to decrease or increase the volume of the system.

[NAVI/AV] Button

- Press this button to display NAVI, press again to return current source.
- Press and hold this button for 2 seconds to display the Dimmer setting menu.

[▲] Eject

- Press to eject disc from the unit.

[MENU] Button

- Press this button to display main menu; press again to return current source.
- Press and hold this button for 2 seconds to turn off the monitor. Press any place of the screen to turn on the monitor again.

[RESET] Button

- Press this button to hardware reset the unit.

Note: When the **[RESET]** button is pressed, frequencies of radio stations, titles, etc. stored in memory are cleared.

[microSD slot]

Note: The microSD card is only for navigation. Please don't insert microSD card for other purpose. After insertion of microSD card for MAP, don't remove it; otherwise, the navigation function will be disabled.

[AUX IN]

AUX 1 Connector.

[Microphone]

This is used for Bluetooth phone.

[IR] SENSOR

- Receiver for the remote control unit (operating range: 30 degree in all directions).

5. REMOTE CONTROL(OPTIONAL)

*Remote control unit is sold separately.

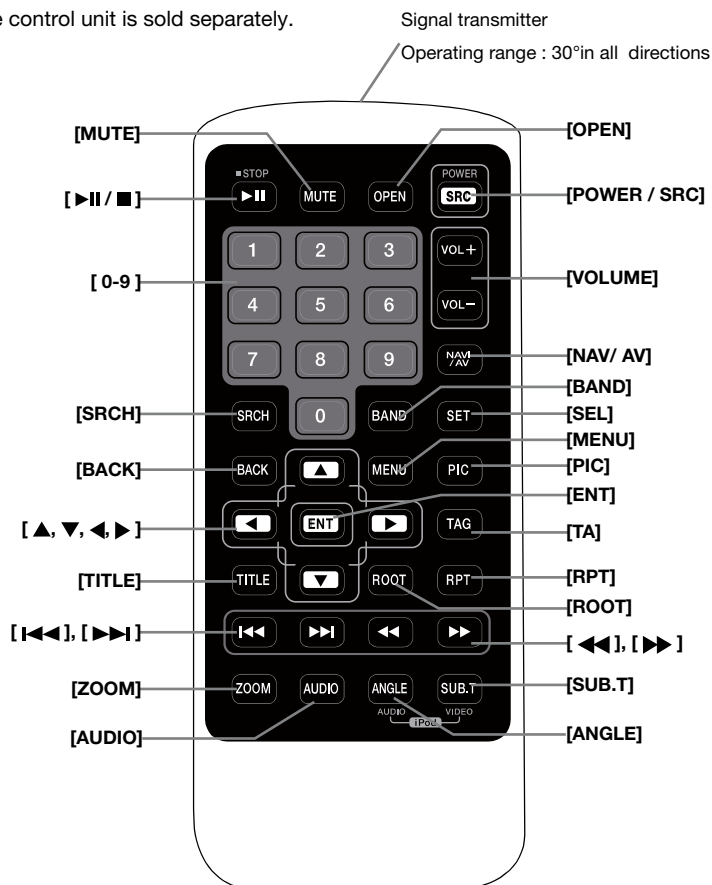

Replacing the batteries

1. Press the retention tab and pull out the battery tray and remove the old battery.
2. Insert the new CR2025 battery and slide the battery tray back in the remote control the same direction that you removed it. Please ensure the tray is inserted in the correct direction.

⚠ CAUTION

- Keep the battery out of the reach of children.
Should the battery be swallowed, consult a doctor immediately.
- Batteries (battery pack or batteries installed) must not be exposed to excessive heat such as sunshine, fire or the like.

⚠ WARNING

Lithium batteries contain
Perchlorate
Dispose of discharged batteries properly.

CAUTION

- Use one CR2025 (3V) lithium battery.
- Remove the battery if the remote control is not used for a month or longer.
- There is a danger of explosion if battery is incorrectly replaced. Replaced only with the same or equivalent type.
- Do not handle the battery with metallic tools.
- Do not store the battery with metallic objects.
- If the battery leaks, wipe the remote control completely clean and install a new battery.

- When disposing of used batteries, comply with governmental regulations or environmental public institutions' rules that apply in your country/area.

► Important

- Do not store the remote control in high temperatures or direct sunlight.
- The remote control may not function properly in direct sunlight.
- Do not let the remote control fall onto the floor, where it may become jammed under the brake or accelerator pedal.

Remote Control Function

You can use the remote control unit to control the NX404AU.

*Remote control unit is sold separately.

Note:

- The wireless remote control operation may not be optimal in direct sunlight.

[▶/⏸/■] Button

- Press this button to play or pause video and audio media.
- Press this button more than 1 second to stop video and audio media.

[MUTE] Button

- Mute or Unmute the speaker.
- The symbol  on upper right area of the screen indicates that speaker is muted.

[POWER/SRC] Button

- Press this button to move the focus to next available source item on main menu.
- Press this button to power on when the unit is power off.
- Press this button more than 1 second to power off when the unit is power on.

[0 - 9] Buttons

- Use in the Key Pad screen to select the radio.
- Use to select the track in the track list screen.
- Press to enter DVD video chapters/titles in the Key Pad screen.

[VOLUME] Buttons

- Increase and decrease volume.

[NAVI/AV] Button

- Press this button to switch between current source and current position on navigation map.

[SRCH] Button

- Press this button to open chapter or title search window while playing DVD.

[BAND] Button

- Switch to next band alternately.

[SET] Button

- Press this button to open the Audio setting menu in any mode.

[BACK] Button

- Press this button to quit main menu if current screen is main menu.

[▲], [▼], [◀], [▶] Buttons

- Press this button for cursor movement in main menu or Setting mode.
- From the main menu, you can select your desired source or change your settings.

[MENU] Button

- Press this button to enter the MAIN MENU or return current resource.

[PIC] Button

- Press and hold this button to change your monitor Dimmer.

[ENT] Button

- Press to fix the entered data in the Key Pad screen or enter the item the cursor is on.

[TA] Button

- Press the button to set TA On or Off.

[TITLE] Button

- Press to go to the title menu on the DVD.

[ROOT] Button

- Press to go to the root menu on the DVD.

[RPT] Button

- Press to perform chapter repeat / title repeat / repeat off while playing DVD mode.
- Press to perform Repeat Track/Repeat All while playing CD.
- Press to perform Repeat Track /Repeat Folder/ Repeat All while playing MP3/WMA, or video files on disc.
- Press to perform Repeat Track /Repeat Folder/ Repeat All while playing MP3/WMA, or video files in USB memory.

[◀▶], [▶▶] Buttons

- Press to seek the next available lower or higher station in Tuner mode.
- Press to select the next higher or lower chapter number in DVD video mode.
- Press to select the next lower or higher track in CD, USB Video, USB Audio mode.
- Press for movement of background source in Navigation mode.

[◀◀], [▶▶] Buttons

- Press to manually select the next higher or lower station in Tuner modes.
- Press to perform fast-backward or fast-forward searching. Press again to change the speed to 2x,

4x, 8x or 16x.

- Press for movement of background source in Navigation mode.

[ZOOM] Button

- Press to turn on and zoom in while playing DVD. You can zoom in up to 3x. (No all DVD disc supports this function).

[AUDIO] Button

- Press to switch the AUDIO channel of the disc while playing DVD.

[SUB-T] Button

- Press to switch next available subtitle while playing DVD.
- Press to display Video menu in iPod mode.

[ANGLE] Button

- Press to switch the different ANGLE while playing DVD. (No all DVD disc supports this function)
- Press to display Audio menu in iPod mode.

[OPEN] Button

- Press to eject disc from the unit.

6. MAIN MENU



- 1 - Tuner---Touch the button to display the Tuner mode.
- 2 - DAB---Touch the button to display the DAB mode.
- 3 - PANDORA--- Touch the button to display the PANDORA mode.
- 4 - Disc Audio---Touch the button to display the Disc Audio mode.
- 5 - iPod Audio---Touch the button to display the iPod Audio mode.
- 6 - Navigation---Touch the button to display the Navigation mode.
- 7 - TV---Touch the button to display the TV mode.
- 8 - USB Audio---Touch the button to display the USB Audio mode.
- 9 - HDMI---Touch the button to display the HDMI mode.
- 10 - Disc Video---Touch the button to display the Disc Video mode.
- 11 - USB Video---Touch the button to display the USB Video mode.
- 12 - iPod Video---Touch the button to display the iPod Video mode.
- 13 - Telephone--- Touch the button to display the Telephone mode.
- 14 - Camera---Touch the button to display the Camera mode.
- 15 - Bluetooth Audio ---Touch the button to display the Bluetooth Audio mode.
- 16 - Setting button---Touch the button to display the Setting menu.
- 17 - AUX1 ---Touch the button to display the AUX1 mode.
- 18 - AUX2 ---Touch the button to display the AUX2 mode.
- 19 - Audio off---Touch the button to make audio source voice off.
- 20 - Rear---Touch the button to display the Rear mode.

Scrolling the menu

Flicking to right or left it will switch to next or previous page of main menu.

Moving the menu position

1. Touch any quadrate icon on main menu more than 2 seconds, the icon will float on main menu.
2. Scrolling the floating icon to any position you want.

7. DVD VIDEO PLAYER OPERATIONS

Discs

Playable discs

This DVD video player can play the following discs.

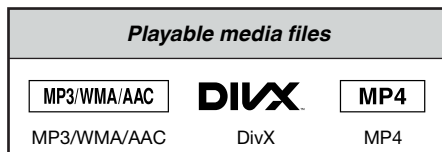
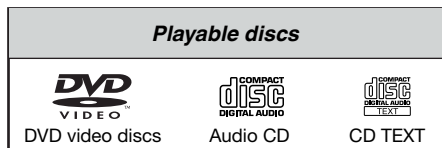

About CD Extra disc

A CD Extra disc is a disc in which a total of two sessions have been recorded. The first session is Audio session and the second session is Data session.

Your personally-created CDs with more than second data sessions recorded cannot be played on this DVD video player.

Note:

- When you play a CD Extra disc, only the first session will be recognized.

About playing a CD-R/CD-RW disc (MP3, WMA)

This player can play CD-R/CD-RW discs previously recorded in music CD format (MP3, WMA).

About playing a DVD-R/RW or DVD+R/RW disc

MP3/WMA files recorded on DVD-R/ RW and DVD+R/RW discs can be played.

Discs that cannot be played back

This DVD video player cannot play back DVD-Audio, DVD-RAM, Photo CDs, etc.

Note:

- It may also not be possible to play back CDs recorded on a CD-R unit and CD-RW unit. (Cause: disc characteristics, cracks, dust/dirt, dust/dirt on player's lens, etc.)
- If a CD-R or CD-RW disc that has not been finalized is played, it will take a long time to start playing. Also, it may not be possible to play depending on its recording conditions.

- You cannot play SuperAudio CD.

The CD player is not supported even if it is a hybrid disc.

About MP3/WMA playback

This unit can play back CD-R/CD-RW, DVD-R/RW and DVD+R/RW discs on which MP3/WMA music data have been recorded.

For a detailed information, see the section entitled "Listening to compressed audio".

Note on region numbers

The DVD video system assigns a region number to DVD video players and DVD discs by sales area. DVD video players sold in Asia can play back DVD discs with the region number "ALL", "4" or any combination of numbers that also incorporate a "4".

The DVD video region number is marked on the disc jacket as shown below.



Change DVD System Settings

Note:

If the setup operation is performed in the middle of DVD video play, the disc will restart from the beginning.

Selecting DVD Setup Menu

1. Touch the **[Settings]** button on the Main Menu to access the Video setup menu.
2. Touch **[Video]** button. The video menu is displayed.



Setting up the Screen Size

Touch the **[DVD Wide Screen Mode]** button to turn on or turn off the DVD wide screen mode.

The factory default setting is "off"

Note: Not all DVD disc support this function.

Setting up the password for parental level control

The factory default pass code is "0000".

1. In **Main Menu** touch **[Settings]** button. Touch **[Others]** button on the display. Touch the **[Set Password]** ---- and a numerical key pad will appear.



Input a new password and come again. The password is set.

Note:

When a disc with view restrictions is inserted, you will be prompted to input this password. The disc will not be viewable until the correct password is entered.

Set rating for parental level control

1. Select **Others** screen while in **Setting** mode. Touch **[Parental Control]** button. Touch the desired rating for level control. Use this table to set the parental level.

Kid Safe	Kid Safe
G	General Audiences
PG	Parental Guidance Suggested
PG-13	Parents Strongly Cautioned
PG-R	Parental Guidance Restricted
R	Restricted
NC-17	No One 17 And Under Admitted
Adult	Only Adult

- The contents that the parental level restricts vary with the country code.

Note: The rating can be selected only under the password unlocked status, and the limits can be set only under the password locked status.

Watching to a Disc

1. To load a disc:

Insert the disc into the center of the insertion slot the label side facing up.

⚠ CAUTION

For your safety, the driver should not insert or eject a disc, opening the operation panel while driving.

Note:

- Never insert foreign objects into the disc insertion slot.
 - If the disc is not inserted easily, there may be another disc in the mechanism or the unit may require service.
 - 8cm (single play) discs cannot be used.
2. Disc starts playing automatically.

⚠ WARNING

Some videos may be recorded at higher than desired volume levels. Increase the volume gradually from the minimal setting after the video has started.

Ejecting a disc

1. To eject a disc press eject **[▲]** button. The play mode then switches to the Tuner mode.

If the disc is left in the ejected position for 10 seconds, the disc is automatically reloaded. In this case, the play mode will remain in the Tuner mode.

Note: If you force a disc into before auto reloading, it may damage a disc. Change DVD System Settings

Showing DVD Player mode screen

After disc is loaded, the play mode is automatically engaged.

Touch any place of the screen to display DVD Video menu touch the screen again to return the playback screen. The display will return to the playback screen, if you do not touch the screen for 10 seconds.

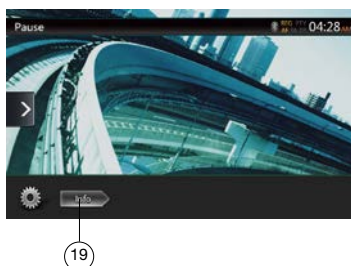

- 1 - Option button
- 2 - Show Cursor button
- 3 - Previous Chapter /Fast Backward button
- 4 - Play/Pause button
- 5 - Next Chapter /Fast Forward button
- 6 - Elapsed playing time
- 7 - Seek bar
- 8 - Total time
- 9 - Menu List button
- 10 - System time
- 11 - Bluetooth status indicator

- 12 - DVD playback information
- 13 - Shortcut button
- 14 - Repeat Switching button
- 15 - Audio Channel switching button
- 16 - Subtitle switching button
- 17 - Angle button
- 18 - Direct chapter or title searching button
- 19 - Information button

Operate the DVD Player Menu

You can select the button items displayed in the DVD menu by directly touching it.

Play/Pause Playback

1. Touch [] button to pause during playback.
2. Touch [] button again to resume playback.

Skip (Search) a Chapter

1. Touch [] or [] button during playback. Chapters are skipped down or up from current locations, as many times as the button is touched, and playback starts.

Skip use seek bar

Touch the triangle on seek bar and drag it to any position where you want to start playback.

Fast Forward/Fast Backward

1. Touch [] or [] button and hold 2 seconds to start fast backward or fast forward during playback. The playback speed starts at 2x, then will increase to 4x, 8x, and 16x. Release the button will continue playing with normal speed.

Note:

- No audio is reproduced during fast forward and fast backward operation.
- The fast forward and fast backward speed may differ depending on the disc.

Search function

You can locate the beginning of a scene using the chapter numbers or title numbers recorded on the DVD Video disc.

1. Showing the DVD Video menu, touch [] button. The Key Pad screen appears with the chapter/Title number input mode.

Touching [] button turns the Key Pad to the chapter number input mode.

Touching [] button turns the Key Pad to the title number input mode.

- Title
 - A large segment to divide the data area of the disc.
 - Chapter
 - A small segment to divide the data area of the disc.
2. Input the number of the title/chapter that you want to play with the [0] to [9] button.
 3. Touch the [] button. Change DVD System Settings



Playback starts from the scene of the input title number or chapter number.

NOTE:

*If the input title/chapter number does not exist or searching with a title/chapter number is not allowed, the screen image will not change.

4. Touch button to close the key pad.

Repeat Playback

This operation plays back chapters recorded on the DVD-Video repeatedly.

1. Showing the DVD Video menu, touch button.
2. Touch button once for Repeat Chapter, again for Repeat Title.
3. Touch button again to turn off the repeat playback.

Using the Title Menu

On DVD discs containing two or more titles, you can select from the title menu for playback.



1. Showing the root menu of DVD Video, touch button during playback.

Touch and hold it during playback to show

- * Depending on the disc, the title or root menu may not be called.
2. Touch the title or root menu screen. And touch the Show Cursor button.
 3. Select the items in the title or root menu screen by directional buttons.
 - * Depending on the disc, items may not be selected with the directional buttons.
 4. Touch button to fix on the selected item.
 5. Touch button.

Switching Audio

On discs in which two or more audios or audio languages have been recorded, you can switch among the audio languages during playback.

1. Showing the DVD Video menu, touch button during playback.

- Each time you touch the button, you can switch among audio languages.
- It may take time to switch among audios. Depending on the disc, up to 8 kinds of audios may be recorded. For details, see the mark of the disc: (8) indicates that 8 audios have been recorded). When the power is turned on and when the disc is changed to a new one, the language set as the factory default is selected. If that language has not been recorded on disc the language is specified on the disc.

Depending on the disc, switching may be completely impossible or impossible on some scenes.

Switching Subtitles

On DVD discs in with two or more subtitle languages have been recorded, you can switch among the subtitle languages during playback.

1. Showing the DVD Video menu, touch button to select a subtitle during playback. Each time you touch the button, you can switch among subtitles.

- It may take time to switch among subtitles.

Depending on the disc, up to 32 kinds of subtitles may be recorded. For details, see the mark of the disc: (8) indicates that 8 kinds of subtitles have been recorded).

Depending on the disc, switching may be completely impossible or impossible on some scenes.

2. To turn off subtitles, repeat touching button until subtitles are turned off.

Displaying the playback status

Touch button on DVD Player mode screen, Playback status is displayed on screen.

Play MP4/DivX video files

This system can play video files (AVI/MP4, etc.) stored on disc.

Note:

DivX Certified® to play DivX® video, including premium content.

Showing video files Player mode screen

1. After disc with video files is loaded, touch [Disc Video] button on MAIN MENU to show video files player mode screen.
2. Touch the screen of the playing video file to display Video files player menu touch the screen again to return the playback screen. The display will return to the playback screen, if you do not touch the screen for 10 seconds.

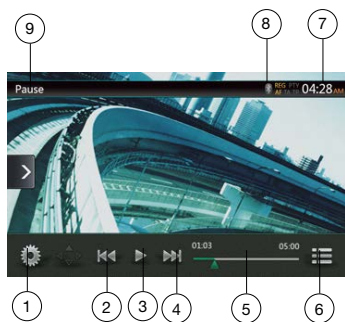

- 1 - Option button
- 2 - Previous Track /Fast Backward button
- 3 - Play/Pause button
- 4 - Next Track/Fast Forward button
- 5 - Elapsed playing time /Seek bar
- 6 - List Mode button
- 7 - System time
- 8 - Bluetooth status indicator
- 9 - Playback information
- 10 - Shortcut button
- 11 - Repeat button
- 12 - Audio button
- 13 - Subtitle button

Operate the Video files Player Menu

You can select the button items displayed in the Video files player menu by directly touching it.

Play/Pause Playback

1. Touch [] button to pause during playback.
2. Touch [] button again to resume playback.

Switch to Previous/Next File

1. Touch [] or [] button during playback to play previous /next file

Skip using seek bar

Touch the triangle on seek bar and drag it to any position where you want to start playback.

Fast Forward /Fast Backward

1. Touch [] or [] button and hold 2 seconds to start fast backward or fast forward during playback. The playback speed starts at 2x, then will increase to 4x, 8x, and 16x. Release the button will continue playback with normal speed.

Note:

*No audio is reproduced during fast forward and fast backward operation.

*The fast forward and fast backward speed may differ depending on the disc.

Repeat Playback

This operation plays back video files recorded on the disc repeatedly.

The repeat set as the factory default is Repeat all.

1. Showing the video files player menu, touch [] button.
2. Touch [] button once for Repeat Track, again for Repeat Folder.
3. Touch [] button again for Repeat All.

Switching Audio

Some video files will have two or more audio channels; you can switch among the audio channels during playback.

1. Touch [] button during playback.
 - Each time you touch the button, you can switch among audio languages.
 - It may take time to switch among audios.

Depending on the disc, switching may be impossible.

Switching Subtitles

Some video files will have two or more subtitles have been recorded; you can switch among these subtitles during playback.

1. Touch the [] button to select a subtitle during playback.
 - Each time you touch the button, you can switch among subtitles.
 - It may take time to switch among subtitles.

Depending on the disc, switching may be impossible.

Video Files List

Showing the Video files player menu; touch the [] button to display video files list screen.

Video files list operations is almost same as Disc Audio player mode. Please refer to CD Player Operations.

Play DivX Video-On-Demand File

You must complete a one-time registration process in order to play a purchased DivX movie on your DivX device.

Registration is not needed to play free DivX movies you create or download.

Getting DivX Registration Code and Registering Your Device

1. Touch the [Settings] button on the Main Menu to access [General] setup menu.
2. Touch [General] setup button, and touch [DISPLAY] button on the right side of "DivX® Registration". You will find "10 digit DivX registration code on the screen.



3. Enter this code in DivX Player to create a "Registration video" disc on your PC. Once this "Registration video" disc has played on this device, registration is done, and you can enjoy some purchased DivX movies on your device.

For detail please visit "<http://www.divx.com/vod>"

4. Touch [OK] to close the pop-up window.

Note:

After you register your device, this setting menu is changed to "DivX® Deregistration"

Deregister your device

Even after you have finished registration, you can deregister your device if you will not watch purchased movies on this device anymore.

1. Touch the [Settings] button on the Main Menu to access [General] setup menu.
2. Touch [General] setup button, and touch [SET] button on the right side of "DivX® Deregistration". You will be asked if you want to deregister this device, then touch [YES] in the pop-up screen.



3. Note 10 digit "Deregistration code" in the pop-up screen. Keep this code until you deregister this device on your PC.

4. Deregister this device by using the "Deregistration code" on your PC.

For detail please visit "<http://www.divx.com/vod>"

Playable Disc Video Formats

This system can play video files stored on disc.

*.avi files

- format: Divx 4/5/6
- Picture size: 720 x 480
- Audio format: MP3
- Audio sampling frequency: 32/44.1/48 KHz

*.mp4 files:

- format: MPEG4 Visual Simple @L1
- Picture size: 720 x 480
- Audio format: AAC
- Audio sampling frequency: 32/44.1/48 KHz

*.mpg files

- format: MPEG2
- Picture size: 720 x 480
- Audio format: MP3
- Audio sampling frequency: 32/44.1/48 KHz

*.divx files

- format: Divx 3.11/4/5/6
- Picture size: 720 x 480
- Audio format: MP3
- Audio sampling frequency: 32/44.1/48 KHz

8. CD PLAYER OPERATIONS

Listening to a Disc/Ejecting a Disc

Please refer to Disc Video Player Operations -watching to a disc and Ejecting a disc.

Showing CD Player Mode Screen

1. After disc is loaded, the play mode is automatically engaged.
2. If disc have been loaded you can touch [Disc Audio] button on main menu to display CD player mode screen.

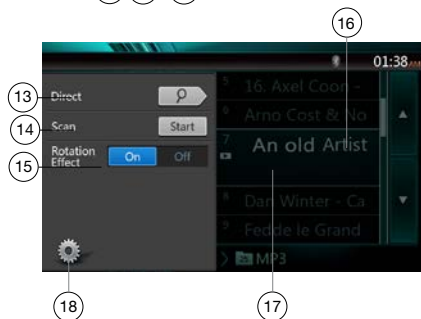
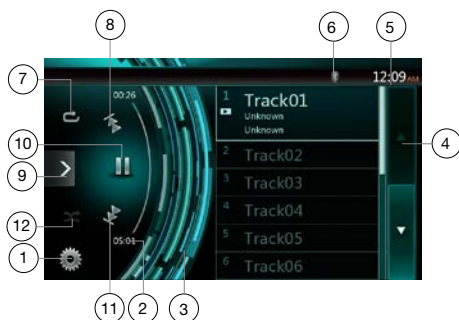

- 1 - Option button
- 2 - Elapsed playing time indicator
- 3 - Rotation effect
- 4 - Page turning button
- 5 - System time
- 6 - Bluetooth status indicator
- 7 - Repeat button
- 8 - Previous Track /Fast Backward button
- 9 - Shortcut button.
- 10 - Play/Pause button
- 11 - Next Track/Fast Forward button
- 12 - Shuffle button
- 13 - Direct Searching button
- 14 - Scan Start/Stop button
- 15 - Rotation Effect On/Off button

- 16 - Song Title
- 17 - Artist/album Information
- 18 - Close option menu button

Operate the CD Player Menu

You can select the button items displayed in the CD player menu by directly touching it in list.

Play/Pause Playback

1. Touch [] button to pause during playback.
2. Touch [] button again to resume playback.

Switch to Previous/Next file or track

Touch [] or [] button during playback to play previous /next file.

- Touching [] button starts playback from the beginning of the next track.
- Touching [] button starts playback from the beginning of the current track. When this button is touched again within 5 seconds, playback starts from the beginning of previous track.

Fast Forward /Fast Backward

1. Touch [] or [] button and hold more than 2 seconds to start fast backward or fast forward during playback. The playback speed starts at 2x, then will increase to 4x, 8x, and 16x. Release the button will continue playback with normal speed.

Note:

* The fast forward and fast backward speed may differ depending on the disc.

Repeat Playback

- * The repeat set as the factory default is Repeat All. Touch [] button switch between Repeat Folder Repeat All and Repeat Track.

Shuffle Playback

1. Touch [] button to shuffle the tracks during playback.
2. Touch this button again to turn off the feature.

Selecting a track on the Track List Screen

This function allows you to select tracks from a displayed list.

1. Touch the track title on the display list. The selected track will start playing.
2. When the desired track is not displayed, touch and flick the track list up or down.
3. Touch the desired track title button. The corresponding track is started playback.

Scanning the Tracks

1. Touch **[Scan]** button to show **[Scan Start]** button.
 2. Touch **[Scan Start]** button during playback.
 - It will play from next track, and each track will display for 10 seconds.
 - The **[Scan Start]** button will switch to **[Scan Stop]** button.
 3. Touch **[Scan Stop]** button.
 - It will continue playback from current track.
 - **[Scan Stop]** button will switch to **[Scan Start]** button.
- * The function will scan all tracks orderly in current folder once. After Scan stopped playback will continue.

Searching with the Track Number

This operation allows searching using the track numbers recorded on the CDs.

1. Touch **[Scan]** button to show **[P]** button.
2. Touch **[P]** button .The numerical keypad will appear on the screen and touch **[OK]** button.
3. Input the track number that you want to play back with **[0]** to **[9]** button and touch **[OK]** button.

Playback starts from the track of the input track number.

- If the input track number does not exist or searching with track number is not allowed, the screen image will not change.
- Touch the **[Back]** button will close the numerical keypad.
- Touch **[Scan]** button will close the option window and display playback screen.



Rotation Effect On/Off

This operation allows turn on/turn off rotation effect. The factory default is On.

1. Touch **[Scan]** button to show **[Rotation effect]** button
2. Touch **[On]** button, will turn on the Rotation effect.
3. Touch **[Off]** button, will turn off the Rotation effect.

Listening to Compressed Audio

This system can play audio files stored on disc. MP3/ WMA/ AAC

Tag Display Function

This unit is an ID3 Tag compatible model.

This unit supports the ID3 TAGs of the Version 2.4, 2.3, 1.1 and 1.0.

In displaying, this unit gives priority to the Version 2.3 and 2.4 TAGs.

Note:

- Some CDs recorded on CD-R/RW mode may not be usable.

Displaying MP3/WMA/AAC TAG titles

Tag information can be displayed for compressed audio file containing Tag information.

- MP3: title, artist, album
- WMA: title, artist
- AAC: can not display tag information.

Precautions when creating MP3 disc

• File extensions

1. Always add a file extension “.MP3” or “.mp3” to an MP3 file, and “.WMA” or “.wma” to a WMA and “.m4a” to a AAC file by using single byte letters. If you add a file extension other than specified or forget to add these file extension, the file cannot be played. In addition, if you use upper case and lower case letters (capital and small letters) mixed for file extensions, normal play may not be possible.

2. Files other than MP3/WMA/AAC data cannot be played.

Playing files with a format not supported will be skipped, and the scan, random and repeat playback mode may be canceled.

• File and Disc Not Supported

Files and discs with following extensions are not supported: *.AAC, *.DLF, *.M3U, *.PLS, *.MP3 PRO files, files with DRM, open session discs.

• Logical format (File system)

1. When writing an MP3/WMA/AAC file on a disc, please select “ISO9660 level 1 or level 2 (without including expansion format)” as the writing software format. Normal playback may not be possible if the disc is recorded on another format.
2. The folder name and file name can be displayed as the title during MP3/WMA/AAC play .

• Entering File and Folder Names

Names using the code list characters are the only file names and folder names that can be entered and displayed. Using any other character will cause the file and folder names to be displayed incorrectly.

• Folder structure

1. A disc with a folder having more than 8 hierarchical levels will conflict with the ISO9660 and playback will be impossible.

• Number of files or folders

1. The maximum allowable number of folders is 200 (including root directory); the maximum allowable number of files is 1500 (max. 200 per folder). This represents the maximum number of tracks that can be played back.

2. Tracks are played in the order that they were recorded onto a disc. (Tracks might not always be played in the order displayed on the PC).

 - Some noise may occur depending on the type of encoder software used while recording.
 - In case of a track recorded at VBR (variable bit rate), the display for the play time of the track may be slightly different from the actual play time. Also, the recommended value of VBR ranges from 32 kbps to 320 kbps.
 - After disc selection, the play mode is automatically engaged.

Playback MP3/WMA/AAC menu

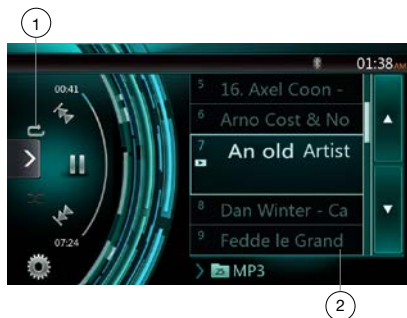

1. Repeat Playback



While playing MP3/WMA/AAC touch  button can switch between Repeat Folder, Repeat All and Repeat Track, Repeat Folder and Repeat All.

2. Current Folder

- Showing title of current folder.
- The number on the folder symbol is the number of files and folders number in current folder.
- Touch the title of current folder, play list will show files and folders in upper folder.

**Other operations about playing MP3/WMA/AAC are almost same as CD Player mode.*

Stop Playback

1. Touch  button to stop playback.
2. Touch  button again to resume playback.

Playback resumes from start of the folder which playing track is in.

- *Other operations about playing MP3/WMA/AAC are almost same as CD Player mode.*

9. USB AUDIO OPERATIONS

This system can play audio files (MP3/WMA/AAC/FLAC) stored in an USB memory which is recognized as "USB Mass Storage Class device". You can use your USB memory as an audio device by simply copying desired audio files into it.

Note:

- This system will not operate or may operate improperly with some USB memory.
- Files protected with any DRM cannot be played.

Notes on Using USB Memories

General notes

- When no support files, the file list display nothing.

Notes on the Audio files

- This system can play the MP3/WMA/AAC/FLAC files stored in the USB memory.

MP3 files:

- format: MPEG1/2 Audio layer3
- bit rate: 8k ~ 320kbps
- sampling frequency: 8/12/16/24/32/44.1/48KHz
- file extension: . mp3

WMA files:

- format: Windows media Audio standard L3 profile
- bit rate: 32 ~ 192KHz
- sampling frequency: 32/44.1/48 KHz
- file extension: .wma

AAC files

- format: Advanced Audio Coding LC-AAC,HE-AAC
- sampling frequency: 32/44.1/48 KHz
- file extension: . m4a

FLAC files

- format: Free Lossless Audio Codec
- quantization bit rate: 16 or 24 bits
- sampling frequency: 44.1~192 KHz
- file extension: . flac

Notes on the folder structure

- The folder hierarchy must be within 8 hierarchical levels. Otherwise, playback may be impossible.
- The maximum allowable number of folders is 65535 (including root directory and folders with no MP3 files, WMA AAC/FLAC file).
- The maximum allowable number of files in a folder is 65535.
- You can store the MP3 files, WMA AAC/FLAC together in a folder.
- The system may become slow if the files or folders exceed the limitation above.

Notes on the Tag titles

The limitations on the Tag titles are same as those in CD Player mode.

Select USB Audio Mode

Connect your USB memory with MP3 files, WMA AAC/FLAC files to the USB connector. The system will automatically detect the connected device, and the **[USB Audio]** button on main menu will be enabled.

- When an USB memory is already connected Touch **[USB Audio]** button to select the USB Audio mode.

The system changes to the USB Audio mode and starts playback from the previous position or from the beginning.

This system has two USB connectors and can connect two USB.

The volume label of the USB is indicated on the list of USB root menu.

And you can select the desired USB by touching the list.

If there is no information of the volume label of the USB. This system indicate the USB as "My USB1", "My USB2" on the list.

Note:

If you reconnect the same device that you disconnected last, the system will play back where it left off.

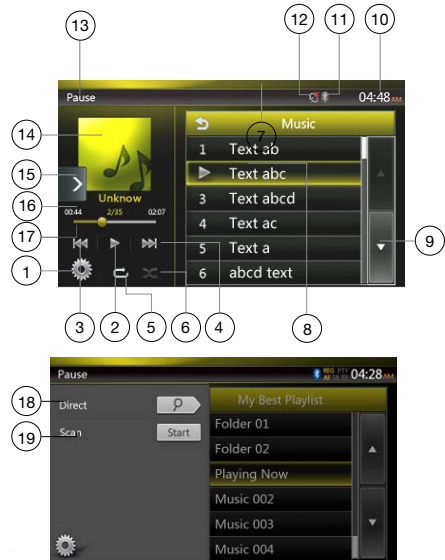



1. Option button
2. Play/Pause button



3. Previous Track /Fast Backward button
4. Next Track/Fast Forward button
5. Repeat button
6. Shuffle button
7. MP3 files, WMA files in list
8. Folders in list
9. Page Turning button
10. System time
11. Bluetooth status indicator
12. Mute status indicator
13. Playback status information
14. Album Art
15. Shortcut button
16. Current ID3 info area
17. Elapsed playing time indicator/Seek bar
18. Direct button
19. Scan button



Playing Audio Files in USB Memory

Play/Pause Playback



1. Touch  button to pause during playback.
2. Touch  button again to resume playback.

Switch to Previous/next file

Touch  or  button during playback to play previous /next file.

- Touching  button starts playback from the beginning of the next track.
- Touching  button starts playback from the beginning of the current track; when this button is touched again within about 5 seconds, playback starts from the beginning of previous track.

Fast Forward /Fast Backward

Touch  or  button and hold more than 2 seconds to start fast backward or fast forward during playback. The playback speed starts at 2x, then will increase to 4x, 8x, and 16x. Release the button will continue playback with normal speed.

Note:

*The fast forward and fast backward speed may differ depending on the audio files.

Repeat Playback

* The repeat set as the factory default is Repeat All.

Touch the  button once for Repeat Track, again for Repeat Folder, Repeat All.

Shuffle Playback

1. Touch  button to shuffle the tracks in playing folder during playback.
2. Touch this button again to turn off the feature.

Album Art work

If current audio file contains album art image in ID3, the picture will be displayed in this area.

ID3 Information Area

This area display ID3 info of playing file: song title, artist information, album information, number of current file/total number in current folder, elapsed playing time/total time of current file.

Skip Using Seek Bar

Touch  on seek bar and drag it to any position where you want to start playback.

Select a Folder on Display List







Touch the folder title on the display list, the display list will display files and folders in selected folder.

Select a Track on the Display List

This function allows you to select tracks from a displayed list.

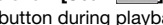
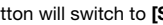



1. Touch the track title on the display list. The selected track will start playing.
2. When the desired track is not displayed, touch and flick the track list up or down.
3. Touch the desired track title button. The corresponding track is started playback.

Scanning the Tracks



1. Touch  button to show  button.
 2. Touch  button during playback.
 - It will play from next track, and each track will display for 10 seconds.
 - The  button will switch to  button.
 3. Touch  button.
 - It will continue playback from current track.
 -  button will switch to  button.
- * The function will scan all tracks orderly in current folder once. After Scan stopped playback will continue.

Searching With the Track Number

This operation allows searching to use the track numbers in playing folder.

1. Touch  button to show  button.
2. Touch  button. The numerical keypad will appear on the screen.
3. Input the track number that you want to play back with  to  button and touch [OK] button.

Playback starts from the track of the input track number.

- If the input track number does not exist or searching with a track number is not allowed, the screen image will not change.
- Touch  button will close the numerical keypad.
- Touch  button will close the option window and display playback screen.



10. USB VIDEO OPERATIONS

This system can play USB video files (MP4, 3GP etc.) stored in an USB memory which is recognized as "USB Mass Storage Class device". You can use your USB memory as an video device by simply copying desired video files into it.

Note:

- This system will not operate or may operate improperly with some USB memory.
- Files protected with any DRM cannot be played.

Notes on Using USB Memories

General notes

When no support files, the file list display nothing.

Notes on the folder structure

The limitations on the folder structure are same as those in USB Audio Player mode.

Notes on the Tag titles

The limitations on the Tag titles are same as those in CD Player mode.

Select USB Video Mode

Connect your USB memory with video files to the USB connector. The system will automatically detect the connected device, and the **[USB Video]** button on main menu will be enabled.

• When an USB memory is already connected

Touch **[USB Video]** button on main menu to select the USB Video mode.

The system changes to the USB Video mode and starts playback from the previous position or from the beginning.

Note: If you reconnect the same device that you disconnected last, the system will play back where it left off.

This system has two USB connectors and can connect two USB.

The volume label of the USB is indicated on the list of USB root menu.

And you can select the desired USB by touching the list.

If there is no information of the volume label of the USB, this system indicates the USB as "My USB1", "My USB2" on the list.

Playing Video Files in USB Memory

If the video is playing, touch the screen of the playing video to display Operation buttons.

- * The display will return to the playback screen, if you do not touch the screen for 10 seconds.

Playable Video Formats

*.mp4 files

- format: MPEG4 Visual
MPEG4 AVC (H.264)
- Picture size: 1280 X 720 (MPEG4 Visual)
1920 x 1080 (MPEG4 AVC)
- Audio format: AAC
- Audio sampling frequency: 32/44.1/48 KHz

*.m4v files

- format: MPEG4 Visual
MPEG4 AVC (H.264)
- Picture size: 720 x 480
- Audio format: AAC
- Audio sampling frequency: 32/44.1/48 KHz

*.mpg files

- format: MPEG2
- Picture size: 720 x 480
- Audio format: MP3
- Audio sampling frequency: 32/44.1/48 KHz

*.3gp files

- format: MPEG4 Visual
H.263
- Audio format: AAC, AMR
- Audio sampling frequency: 8/16/32/44.1/48 KHz

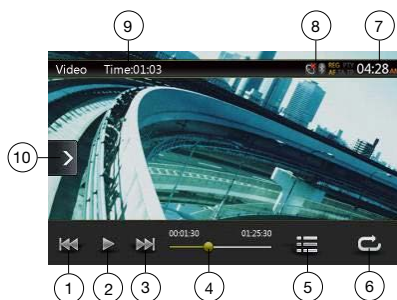

- 1 - Previous Track /Fast Backward button
- 2 - Play/Pause button
- 3 - Next Track/Fast Forward button
- 4 - Elapsed playing time indicator/Seek bar
- 5 - Menu List
- 6 - Repeat button
- 7 - System time
- 8 - Bluetooth status indicator
- 9 - Playback information
- 10 - Shortcut button

Play/Pause Playback

1. Touch **[]** button to Pause playback.

2. Touch [▶] button to resume playback.

Switch to Previous/next file

Touch [◀] or [▶] button during playback to play previous /next file.

- Touching [▶] button starts playback from the beginning of the next track.
- Touching [◀] button starts playback from the beginning of the current track; when this button is touched again within about 5 seconds, playback starts from the beginning of previous track.

Repeat Playback

* The repeat set as the factory default is Repeat All.

Touch the [↺] button once for Repeat Track, again for Repeat Folder, again for Repeat All.

Skip Using Seek Bar

Touch the [◻] on seek bar and drag it to any position where you want to start playback.

Switching to USB Video Menu

Touch [≡] button playback will be paused, and the screen will switch to USB Video List.

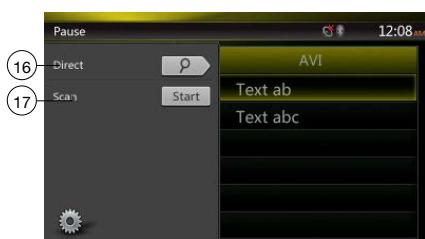

- 1 - Option button
- 2 - Play/Pause button
- 3 - Previous Track /Fast Backward button
- 4 - Next Track/Fast Forward button
- 5 - Repeat button
- 6 - Shuffle button
- 7 - Video files in list
- 8 - System time
- 9 - Bluetooth status indicator
- 10 - Mute status indicator

- 11 - Playback status information
- 12 - Album Art
- 13 - Shortcut button
- 14 - Current file information area
- 15 - Elapsed playing time indicator/Seek bar
- 16 - Direct button
- 17 - Scan button

Play/Pause Playback

*On USB Video menu screen, playback status is pause.

Touch [▶] button to resume playback. The screen will go to video screen automatically.

Switch to Previous/next file

Touch [◀] or [▶] button during playback to play previous /next file.

- Touching [▶] button starts playback from the beginning of the next track.
- Touching [◀] button starts playback from the beginning of the current track; when this button is touched again within about 5 seconds, playback starts from the beginning of previous track.

Repeat Playback

* The repeat set as the factory default is Repeat All.

Touch the [↺] button once for Repeat Track, again for Repeat Folder, again for Repeat All.

Shuffle Playback

1. Touch [≡] button to shuffle the tracks in playing folder during playback.
2. Touch this button again to turn off the feature.

Current File Information Area

This area displays information of current video file: file name, number of current file/total number in current folder, Elapsed playing time/total time of current file.

Skip Using Seek Bar

Touch [◻] on seek bar and drag it to any position where you want to start playback.

Select a Folder on Display List

This operation is same as this in USB Audio mode.

Selecting a Track on the Display List

This operation is same as this in USB Audio mode.

Scanning the Tracks

This operation is same as this in USB Audio mode.

Searching with the Track Number

This operation is same as this in USB Audio mode.

11. iPod OPERATIONS

iPod/iPhone can be connected by using the connector cable supplied with the iPod/iPhone, but in this case, you can enjoy its audio sound only. To enjoy video movies stored in the iPod/iPhone with video displaying them on this unit, it is required to use the special connector cable (CCA-750) separately sold. However the new products such as iPhone 5, iPhone 5s and iPhone 5c, iPod touch® (5th generation) and iPod nano® (7th generation) only can connect 10-pin cable (no video signal output), so these new products cannot displaying video in video mode.

Note:

- This system will not operate or may operate improperly with unsupported versions.
- For detailed information on the playable iPod/iPhone models, see our home page: www.clarion.com

Notes on using Apple iPod/iPhone

- Do not connect an iPod/iPhone to this unit with a headphone connected to the iPod/iPhone.
- After the iPod/iPhone has been connected to this unit, the buttons of iPod buttons are disabled for operation in the Music mode. In the Video mode, do not operate the buttons of iPod.
- When in the iPod mode, the screen image input from the AUX terminal is output to the rear monitor.
- When no data is present, the title display will remain blank.
- Set the language setting of iPod/iPhone to English before connecting your iPod/iPhone. Some characters of the other languages may not be displayed correctly in this system.

• Precautions on battery consumption:

If the iPod/iPhone is connected to this unit when the internal battery of iPod/iPhone has run down, this function may not operate correctly. You must connect the iPod/iPhone after charging the battery if it has run down.

iPod Audio Menu Operations

Connect your iPod/iPhone to the USB connector. The system will automatically detect the connected device and the iPod Audio button will be enabled for operation on the Main Menu screen.

Note:

1. This system has two USB connectors, please connect to the USB with the label of "iPod/iPhone". By connecting another USB cable, iPod/iPhone can't play back the music.
2. When iOS device is connected via both USB and Bluetooth at the same time and select iPod mode, iOS device is controlled by USB connection.
3. When the iPod mode and operate the audio player

or internet radio other than iPod, there is a case that iPod doesn't playback correctly. Please don't operate the audio player or internet radio other than Pandora when the Pandora mode.

4. During iOS device is connected by Bluetooth, and select the iPod mode, the volume level is controlled by only iOS device.
5. During iOS device is connected by Bluetooth, Album jacket image is not displayed.



The playback starts after a while, from where the iPod/iPhone has been paused.

- When iPod/iPhone is already connected



Touch the [iPod Audio] button on the Main Menu screen. The system changes to the iPod mode, and starts playback from the previous position.

Press MENU button on Operational Panel to return to the Main Menu.

iPod Audio ID3 Info

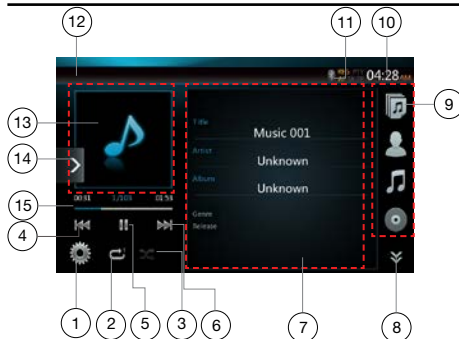

- 1 - Option button
- 2 - Repeat button
- 3 - Shuffle button
- 4 - Previous Track /Fast Backward button
- 5 - Play/Pause button
- 6 - Next Track/Fast Forward button
- 7 - ID3 Information

- 8 - Next Page [] / Previous Page [] button
 9 - Category List
 10 - System Time
 11 - Bluetooth Status indicator
 12 - Playback Status indicator
 13 - Art Work
 14 - Shortcut button
 15 - Progress bar

Play/Pause Playback

1. Touch [] button to pause during playback.
2. Touch [] button again to resume playback.

Switch to Previous/next file

- Touch [] or [] button during playback to play previous /next file.
- Touching [] button starts playback from the beginning of the next track.
- Touching [] button starts playback from the beginning of the current track; when this button is touched again within about 5 seconds, playback starts from the beginning of previous track.

Fast Forward /Fast Backward

Touch [] or [] button and hold more than 2 seconds to start fast backward or fast forward during playback.

Note:

*No audio is reproduced during fast forward and fast backward operation.

*The fast forward and fast backward speed may differ depending on the audio files.

Repeat Playback

* depend on iPod.

1. Touch the [] button once for Repeat Track, again for Repeat All.

Shuffle Playback

1. Touch [] button to shuffle the tracks in playing folder during playback.
2. Touch this button again to turn off the feature.

Album Art work

If current audio file contains album art image in ID3, the picture will be displayed in this area.

ID3 Information Area

This area display ID3 info of playing file: song title, artist information, album information (Genre, playlist and release time).

Category List

Select different category songs to play. The category is same as the iPod/iPhone.

iPod Audio Playlist Mode Screen



- 1 - Switch to Information button
- 2 - Playing List
- 3 - Page turning button



- 4 - Back to father folder
- 5 - Close the list mode
- 6 - Search with the first alphabet in current list

iPod Audio List Mode Screen

- In the ID3 information mode screen, touch the ID3 info area to switch the playing list, and in the playing list mode screen, touch the button [] can back to the father folder. If the list is in root, touch it can close the list.
- Touch the button [] to back to the father folder. If the list is in root, touch it can close the list.
- Touch the button [] to close the List and back to the ID3 information mode.

Simple Control Mode

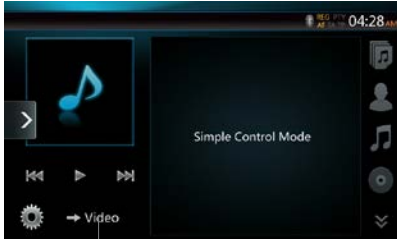
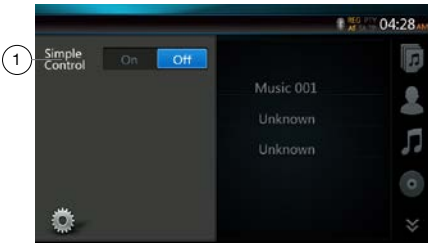

1 - Simple Control button

2 - Video Mode button

- If the Simple Control is set to **[Off]** in option menu, the screen will become Simple Control Mode. It can also display the video of iPod/iPhone regardless it is iPod Audio or iPod Video mode. But only “Previous Track”, “Play/Pause” and “Next Track” can be operated.
- Touch **[→ Video]** the video will play from iPod.

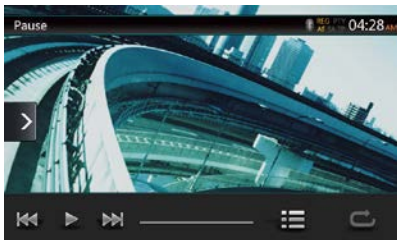

Skipping a Track (Simple Control Mode)

Touch the **[⏮]** or **[⏭]** button during playback. Tracks are skipped, as many times as the button is touched, and playback starts.

- Touching the **[⏭]** button, starts playback from the beginning of the next track.
- Touching the **[⏮]** button, starts playback from the beginning of the current track.

When this button is touched again within about 5 seconds, playback starts from the beginning of the

previous track.

Note: In Simple Control Mode, the best way is to control the iPod just on iPod.

Selecting a list item from a list screen

- (1). Touch the list screen and flick up or down to scroll the list.
- (2). Touch a desired list item on the screen to display the corresponding list of tracks.
- (3). Touch the desired track name on the list to play it.

iPod Video Menu Operations

Connect your iPod/iPhone to the USB connector. The system will automatically detect the connected device and the iPod Video button will be enabled for operation on the Main Menu screen.



- When an iPod/iPhone is already connected

Touch the [] button on the Main Menu screen. The system changes to the iPod Video mode, and starts playback from the previous position.

Touch MENU button on Operational Panel to return to the Main Menu.

- Viewing video data in the iPod/iPhone (only for the iPod/iPhone with video features)

When you connect an iPod/iPhone with video features by using the optional connector cable for iPod/iPhone with video, you can enjoy the video data and slide show data stored in the iPod/iPhone and show them on the display of this unit (and the rear monitor if connected).

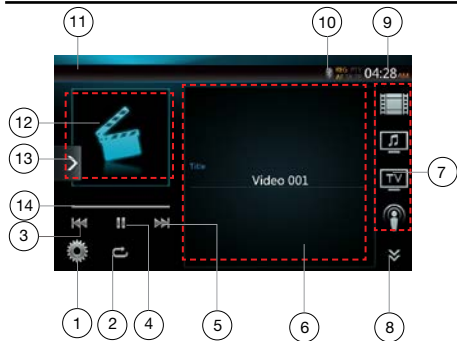

iPod Video ID3 Mode Screen







- 1 - Option button
- 2 - Repeat button
- 3 - Previous Track button
- 4 - Play/Pause button
- 5 - Next Track button
- 6 - Playing File Title
- 7 - Category list
- 8 - Next Page[] / Previous Page[] button
- 9 - System time

- 10 - Bluetooth Status indicator
- 11 - Playback Status indicator
- 12 - Art work
- 13 - Shortcut button
- 14 - Progress bar

Play/Pause Playback

1. Touch [] button to pause during playback.
2. Touch [] button again to resume playback.

Switch to Previous/Next File

- Touch [] or [] button during playback to play previous /next file.
- Touching [] button starts playback from the beginning of the next track.
- Touching [] button starts playback from the beginning of the current track.

Repeat Playback

* The repeat set as the factory default is depend on iPod/iPhone.

1. Touch the [] button once for Repeat One, again for Repeat All, again for Repeat Off.

Album Art work

If current audio file contains album art image in ID3, the picture will be displayed in this area.

ID3 Information Area

The area is display the title of the playing file.

Category List

Select different category songs to play. The category is same as the iPod/iPhone.

iPod Video List Mode Screen

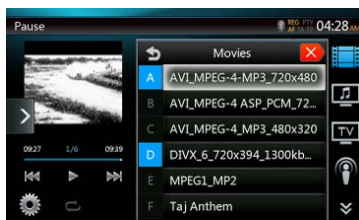

This operation is same as this in iPod Audio mode.

iPod Video Simple Control Mode Screen

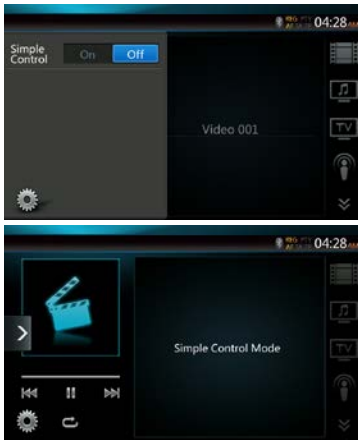

This operation is same as this in iPod Audio mode.

iPod Video Play Mode Screen

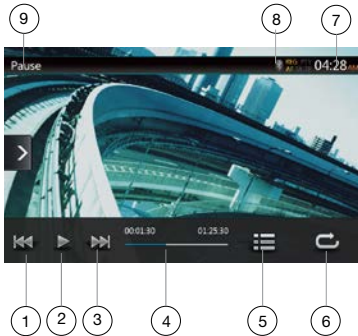

- 1 - Previous Track /Fast Backward button
- 2 - Play/Pause button
- 3 - Next Track/Fast Forward button
- 4 - Progress bar
- 5 - Menu List button
- 6 - Repeat button
- 7 - System time
- 8 - Bluetooth status indicator
- 9 - Playback information

Play/Pause Playback

1. Touch [] button to pause during playback.
2. Touch [] button again to resume playback.

Switch to Previous/Next Track

- Touch [] or [] button during playback to play previous /next track.
- Touching [] button, starts playback from the

beginning of the next track.

- Touching [] button, starts playback from the beginning of the current track; when this button is touched again within about 5 seconds, playback starts from the beginning of previous track. beginning of the current track.

Fast Forward /Fast Backward

Touch [] or [] button and hold more than 2 seconds to start fast backward or fast forward during playback. Release the button will continue playback with normal speed.

Note:

*No audio is reproduced during fast forward and fast backward operation.

*The fast forward and fast backward speed may differ depending on the audio files.

Repeat Playback

- * The repeat set as the factory default is Repeat Off. Touch the [] button once for Repeat One, again for Repeat All, again for Repeat Off.

Note:

The operation in iPod video mode are as same as iPod Audio mode. Please refer to the iPod Audio Mode operation.

Note:

Video playback is not available on all iPod/ iPhone devices. Please contact your Clarion dealer for details. An optional connection cable or accessory may be required for this feature.

Note:

- "AUDIO ONLY" is displayed when the automobile is moving.
- Image data may not be played back according to the status of the iPod/iPhone
- The volume setting of video data is relatively lower than audio data. Be sure to lower the volume setting before switching to the other mode.
- Do not select the categories with no track registered from the iPod menu screen. The iPod/iPhone may be frozen. If the iPod/iPhone is frozen, reset the iPod/iPhone by following the procedure described in the instruction manual of the iPod/iPhone.
- Audio may be played back slightly out of synchronization with video images.

iPod Audio Bluetooth Mode

When your iPod/iPhone have connected via bluetooth to this unit, you can also enter iPod Audio mode. The operation is same as the normal iPod Audio mode.

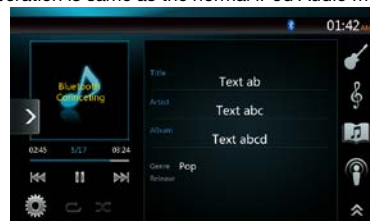

12. Pandora® OPERATIONS

If you have any issues with the Pandora application on your mobile phone, please direct them to pandora-support@pandora.com.

Selecting the Pandora Mode

1. Turn on Pandora function of your iPod.
2. Connect your iPod/iPhone/Android to the unit.
3. When iPod/iPhone/Android is already connected, touch the

[Pandora] icon on the Main Menu screen.

- Pandora mode now playing screen / Pandora mode information screen

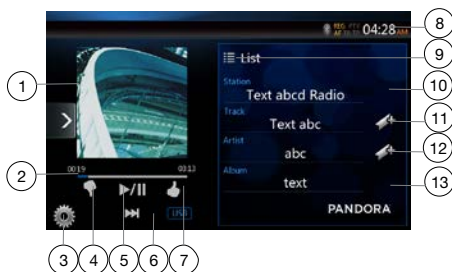

- 1 - Art Work
- 2 - Progress bar
- 3 - Settings button
- 4 - Thumbs down

Touch this button Thumbs-down current track and play next track.

- 5 - Play/Pause button

Use to control playback and pause.

(1). Touch the button during playback. Playback pauses.

(2). To resume playback touch the button again.

- 6 - Next track button
- 7 - Thumbs up
- 8 - System time
- 9 - List button

Touch this button to show List Screen

- 10 - Current station name
- 11 - Current title.

Touch icon to store current title to track favorites list.

- 12 - Current artist.

Touch icon to store current artist to artist favorites list.

- 13 - Current album name.

- Skipping a track (Pandora mode)

Touch [Thumbs up] button during playback, tracks are skipped and starts playback from the beginning of the next track.

Note:

- Some track are not able to be skipped.

- If skip limit has been reached, this function will not be available.
- Track rating
Touch [Thumbs down] or [Thumbs up] button to Thumbs down or Thumbs up current track, and the button will light.
Note:
• Touch [Thumbs up] button will skip to next track (skip limit has not been reached).
- Some track is not able to be rated (i.e. audio ads and shared station content). The thumbs buttons will be disabled.

- Bookmarking

Touch [Thumbs up] button to store current title or artist to track favorites list.

Note:

- Some track are not able to be bookmarked (i.e. audio ads). In this case the bookmark buttons will be disabled.
- Pandora Mode Station List

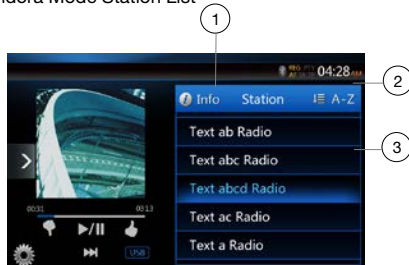

- 1 - [Info] button

Touch this button to display Information Screen.

- 2 - [A-Z] button

Touch this button to sort the list by first letter, touch again to sort the list by date.

- 3 - Station list, touch to select station play.

When the desired station is not displayed, touch and flick the station list up or down.

- Pandora Mode Station List

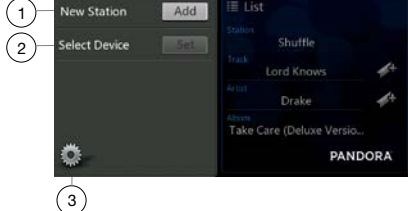

- 1 - Add a new Station
- 2 - Select a device
 - This “Select Device” key is used when connecting iPhone by the USB and connecting the Android by Bluetooth. The default setting, the USB connection has priority
- 3 - Close the setting screen

Pandora Bluetooth Mode

When your mobile phone has connected to the unit via Bluetooth. You can also enter the Pandora mode. The operation is the same as the normal Pandora mode.



1

- 1 - BT mode

When connected via Bluetooth. This icon will change from USB to BT

Note:

1. Pandora internet radio may not be available in all areas due to government restrictions.
2. When the Pandora mode starts, this system chooses the previously connected device (Android or iOS). When it is connected Android(BT), iPhone(BT or USB) together, and “Do not show again” is not checked, display the popup of choose device.
3. “Select Device” button might not sometimes work normally if you connect other mobile phone during Pandora mode. We recommend to connect other mobile phone after closing Pandora mode.
4. Other audio applications will not work correctly when the unit is set to Pandora mode. Exit Pandora mode to use other applications.
5. When playing Pandora mode via Bluetooth, audio volume level is affected by the volume of mobile phone.

13. Bluetooth® AUDIO PLAYER OPERATIONS

Some Bluetooth cellular phones have audio features, and some portable audio players support the Bluetooth feature. These devices will be called as "Bluetooth audio players" in this manual. This system can play audio data stored in a Bluetooth audio player.

Note:

- This system will not operate or may operate improperly with some Bluetooth audio players.
- For detailed information on the playable Bluetooth audio players, see our home page: www.clarion.com

Selecting the Bluetooth Audio Mode

1. Touch the [Bluetooth Audio] button to select the Bluetooth Audio mode.

The system changes to the Bluetooth mode. If the connection with a Bluetooth audio player has been already established, you may select the Music function.

2. Touch MENU button on Operational Panel to return to the Main Menu.

- When the connection with blue icon a Bluetooth audio player has been established, the [Bluetooth] icon is displayed at the top of the screen.

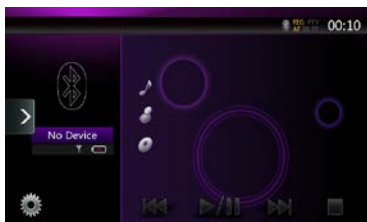

Bluetooth Audio Player Settings

You can confirm various information concerning about the Bluetooth Interface features.

1. Touch the [Settings] button to display the information on the screen.
2. When you finish confirming the Bluetooth information, touch the [Settings] button to return to the previous screen.



Registering your Bluetooth audio player (Pairing)

You can register up to 5 Bluetooth audio players. Your mobile phone Bluetooth version is under 2.0. Please input PIN code "0000".

1. Turn on the power of the Bluetooth audio player you wish to register.
2. Touch the Device button [Bluetooth] to display the Device Select screen.

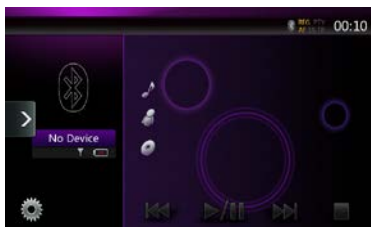

3. Touch the [L+] button to display the Inquiring Device screen.

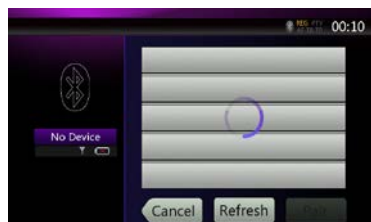

4. Touch your desired device button and touch [Pair] button to register for the Bluetooth audio player. Then select an image of this device.



And select a type of this device.



When the pairing operation completes, the registered Bluetooth audio player is set as the current device, after selecting the favorite icon, the display return to the device list screen. Touch the [Back] button, the display will return to the Bluetooth audio mode screen.



• To delete the Bluetooth audio player registration

1. Touch the [Cut] button to delete the device.

A confirmation screen is displayed.

2. Touch the [Yes] button to confirm delete.

Selecting the Bluetooth Audio Player

To change the current Bluetooth audio player to the other device which is already registered, perform the following operation.

1. Touch the device button to [Bluetooth] display the Device Select screen.
2. Touch the currently connected device button, then touch the [Cut] button to disconnect the active device.
3. Touch the desired device button you wish to use. Touch the [Connect] button to select it as your active device. The corresponding cellular phone is set as current telephone.
4. Touch the [Back] button to return to the previous screen.

Controlling the Bluetooth Audio Player



Note:

- Occasionally, depending on the environment, playback sounds may be fragmented, or switch noises may be generated.

Playing a Music

After the connection with a Bluetooth audio player is established, the play mode is automatically engaged.

- When playback is not started for some devices, touch the [Play/Pause] button manually.

Pausing Playback

1. Touch the [Play/Pause] button during playback.

Playback Pauses.

2. To resume playback, touch the [Play/Pause] button. Playback resumes.

Skipping a Track (searching)

3. Touch the [Previous] or [Next] button during playback.

Stopping Playback

4. Touch the [Stop] button during playback.

Tracks are stopped, touch the [Play/Pause] button to playback the first Track.

Show Track List

5. Touch the [Track List] button to show the current track list. Touch the [Search] button to show all of the lists. And you can playback any tracks by touch the items in the list.

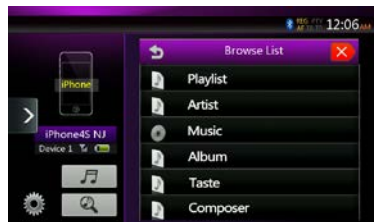
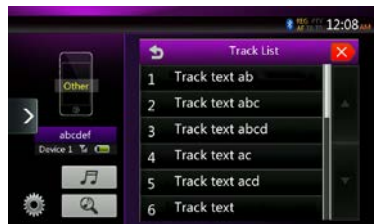

14. Bluetooth® TELEPHONE OPERATIONS

When the connection with your Bluetooth cellular phone is established, the following functions are available on this unit:

- Listening to your telephone calls on the car speakers.
- Answering to an incoming call.
- Making a call using the Ten-Key pad screen.
- Making a call using the Phone Book data in the selected cellular phone.
- Making a call using the History data of the dialed/ received calls.

Note:

- Some cellular phones may not be able to transfer the Phone Book data to head unit.
- The Phone Book data transmission may take a long time. The operations of sending calls are disabled during the data transmission.

Select the BT Phone Mode

1. Touch the [Bluetooth Telephone] button to select the Bluetooth Telephone mode.

The Telephone screen is displayed.

2. Touch MENU button on Operational Panel to return to the Main Menu.
- When no Bluetooth Telephone connected, the icon  is displayed at the top of the screen.

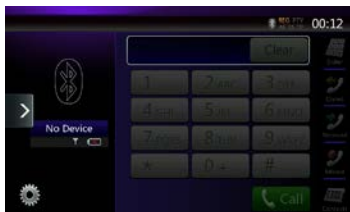



- When the connection with a Bluetooth Telephone has been established, the icon  and signal level indicator are displayed at the top of the screen.



Bluetooth Telephone Settings



You can confirm various information concerning about the Bluetooth Interface features.

1. Touch the  button to display the information on the screen.
2. Perform setting for the desired item. See the following sections for detail.
3. When you finish confirming the Bluetooth information, touch the  button to return to the previous screen.



Setting Automatic Connection



The system automatically reconnects the cellular phone after the connection is lost or the system is restarted.

- The factory default setting is "ON". Touch the  or  button of the Automatic Connection item to set the function ON or OFF.

Note: The "auto-connect" is effective to the cellular-phone of last connecting.

Setting Automatic Answer

If a call comes in, answer automatically after 5 seconds.

- The factory default setting is "OFF". Touch the  or  button of the Automatic Answer item to set the function ON or OFF.

Setting Microphone Gain

You can adjust the input level of the microphone in 16 levels.

- Touch the level indicator button of the Microphone Gain item to adjust the input level.

Note:

- The input level of the microphone can be affected by its surroundings. Adjust the level if the person on the other end of the telephone has a reception problem.

Registering Your Cellular Phone (Pairing)

You can register up to 5 cellular phones. The registering method is as same as "Registering your Bluetooth audio player".

Your mobile phone Bluetooth version is under 2.0.

Please input PIN code "0000".

1. Turn on the power of the cellular phone you wish to register.
2. Touch the device button  to display the Device Select screen.

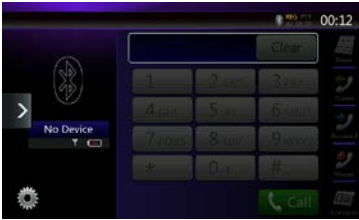

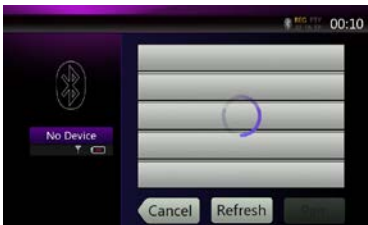

3. Touch the  button to display the Inquiring Device screen.



4. Touch your desired Cellular button to select the button for the cellular phone to be registered, and touch  button to register for the Bluetooth cellular phone.
 - You cannot select the Cellular button of which another cellular phone is already registered. Select a blank Cellular button.
5. If entering the Pass Key code is prompted on your cellular phone, enter the Pass Key code set in this unit.
 - You can change the Pass key setting of this unit from the Bluetooth Info screen under the Telephone Settings screen.







When the pairing operation completes, the registered cellular phone is set as the current telephone, and the display returns to the Telephone screen.

- To delete the cellular phone registration
 1. Touch the  button to delete the device. A confirmation screen is displayed.
 2. Touch the  button to confirm delete.

Select the Cellular Phone

To change the current cellular phone to the other device which is already registered, perform the following operation.

1. Touch the  button to display the Device Select screen.
2. Touch the currently connected device, then touch  button to disconnect the active device.
3. Touch the desired device button you wish to use. Touch  button to select it as your active device. The corresponding cellular phone is set as the current telephone.
 - If the power of the cellular phone is not turned on, turn it on.
 - The cellular phone may prompt to acknowledge the Bluetooth connection or to enter the Pass Key code of this unit. Perform these operations according to the message displayed.
4. Touch the  button to return to the previous screen.

Obtaining the Phone Book Data

Sending the Phone Book data from the cellular phone enables you to make a call using the Phone Book function from this unit.

Telephone Operations

Making a call using the Ten-Key pad

1. Touch the  button to display the Ten-Key pad screen.
2. Enter the telephone number by using the Ten-Key pad displayed on the screen.



3. Touch the **[Call]** (Send) button to call the entered number.

- The following Telephone Interrupt screen is displayed during phone call.



- Touch the **[Mute]** button to talk by using the cellular phone and canceling the hands-free function (Private Mode). To return to the hands-free mode, touch the **[Mute]** button again.
- Touch the **[Mute]** button to mute the microphone. Now you can hear the other side, but the other side cannot hear your side.
- Touch the **[Hold]** button to hold the current phone call, now you can answer to the other incoming call. Touch again to talk with previous call.

If during a call with a third-party call, you can keep the current call to answer a third party or hang up the current call to answer a third party. You can also ignore the third-party calls.

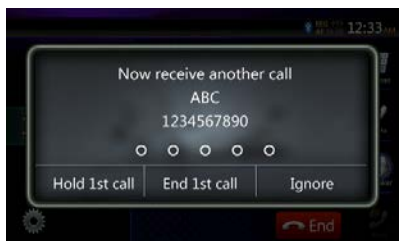

4. When the call is finished, touch **[End]** button to hang up.

Note:

- Depending on some special cellular phone, the Telephone Interrupt screen may be closed and the connection with this system may be disconnected when entering the Private mode.

Making a Call Using the Phone Book

You can use the Phone Book data obtained from the cellular phone to make a call from this unit.

Note:

- Before using this function, the Phone Book data must be sent from the cellular phone.
- Only the Phone Book items with at least one telephone number registered in the captured Phone Book data are displayed on the Phone Book screen.

1. Touch the **[Contacts]** button to display the Phone Book screen.
2. Touch the desired name button you wish to dial.
 - Flick the list up and down to scroll the list.
3. Touch the **[Call]** button to call the specified number. The Telephone Interrupt screen is displayed, and calling starts.
- When the call is finished, touch the **[End]** button to hang up.

Making a Call Using the History

The system will memorize the Dialed/Received calls record data in the memory. You can confirm it and use it to make a call from this unit.

1. Touch the **[History]** button. The History List screen is displayed.
 - The items are sorted by Dialed, Missed and Received calls.
 - Flick the list up and down to scroll the list.
2. Touch the desired History item button you wish to dial.
3. Touch the **[Call]** button to call the specified number. The Telephone Interrupt screen is displayed, and calling starts.
- When the call is finished, touch the **[End]** button to hang up.

Answering to an incoming call

When a call comes in, the following Telephone Interrupt screen appears.

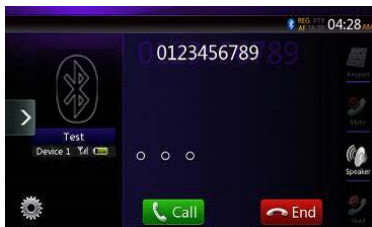

You can answer to the incoming call on this system by the following operation.

1. Touch the **[Call]** button to answer the call.
2. When the call is finished, touch the **[End]** button to hang up.

15. TUNER OPERATIONS

Listening to the Tuner

1. Touch the Tuner button on the Main menu display. The tuner mode screen is displayed.
2. Touch the [FM1/FM2/FM3/AM] button to select the radio band. Each time the button is touched, the radio reception band changes in the following order: FM1->FM2->FM3->AM -> FM1...

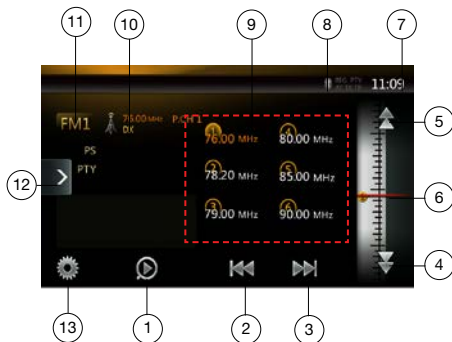

1. Preset Scan button
2. Seek Down
3. Seek Up
4. Step Down
5. Step Up
6. Frequencies display
7. System time
8. Bluetooth status indicator
9. Preset list
10. DX/Local indicator
11. Band button
12. Shortcut button
13. Option button

Seek Tuning

1. Touch the [FM1/2/3/AM] button to select the radio band (FM or AM).
2. Touch the [↗] or [↘] button
 - When Touch the [↗] button, the station is searched in the direction of higher frequency.
 - When Touch the [↘] button, the station is searched in the direction of lower frequency.

Step Tuning

1. Touch the [FM1/2/3/AM] button to select the radio band (FM or AM).
2. Touch the [↖] or [↗] button in frequency menu to tune up or down by one step.

Recalling a preset station

1. Touch the [FM1/2/3/AM] button to select the desired band (FM or AM) on the tuner.
2. Touch the preset station (1 to 6) on Preset list.

Manual memory

1. Touch the desired band button to select the band you wish to store.
2. Tune to a station you want to store using the seek tuning, step tuning, or preset tuning.
3. Touch and hold the desired Preset button you want to store for about 2 seconds.

Auto Store

The Auto Store is a function for storing up to 6 stations that are automatically searched in sequentially. If the number of receivable stations cannot reach to 6, the previous stored station remains.

1. Touch the [FM1/2/3/AM] button to select the desired band. (FM or AM)
2. Touch the [⏹] button, and then touch the [Start] button to start the Auto Store.

A beep sounds and the stations with good reception are stored automatically to the preset list.

Notes:

1. After auto store, the previous stored stations will be overwritten.
2. The unit has 4 bands, but FM3 and AM can store by Auto Store function.

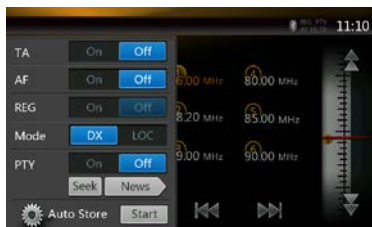

Preset Scan

The Preset Scan receives the stations stored in the preset memory in order. This function is useful when searching for the desired station in memory.

1. Touch the [FM1/2/3/AM] button to select the desired band. (FM or AM)
2. Touch the [⏹] button to start the Preset Scan. The unit starts scanning each station for 10 seconds sequentially. But the station stored is not a valid station; the scanning time is only 2 seconds.
3. When the desired station is tuned in, touch the [⏹] button again to stay in that station.

DX/Local Setting

The DX / Local setting changes the tuner sensitivity in order to separate closely spaced stations. This feature is useful in areas that have many radio stations in close proximity.

1. Touch the [LOC] button to switch to local tuner sensitivity.
2. Touch the [DX] button to switch to DX tuner sensitivity.

16. TV OPERATIONS

When TV device connect to unit, you can watch TV program and operate DVB-T device.

Different DVB-T device have different operate mode, please read the user manual of the DVB-T device connected to unit.

This function is available when a DVB-T Black Box is connected.

This unit can control the following DVB-T Black Box: (DTX502E)

*DTX502E is sold separately.

Note:

For your safety, the unit has a safety function, which turns off the picture when car is moving, so only the audio can be heard. The picture can be only watched, when the car is stopped and parking brake is applied.

Switching to DVB-T mode

- Touch **[TV]** key on Main Menu to select desired mode (when unit is reading). The LCD will display the external video. If there is no DVB-T signal, it will show you blank screen.
- Press **[Menu]** button on Operational Panel to return to the Main Menu.

17. DAB OPERATIONS

Setting to DAB

Before using DAB system, please set the adjust in Settings.

Please select "DAB" in DAB/TV(Optional) of Settings to activate DAB icon on Main menu.

Listening to the DAB

1. Touch the DAB button on the main menu display. The DAB mode screen is displayed.
2. Touch the [DAB1/DAB2/DAB3] button to select the DAB band. Each time the button is touched, the DAB reception band changes in the following order: DAB1->DAB2->DAB3->DAB1 -> DAB2...

Note:

1. There is the area where DAB is not broadcasted.
2. This content is optional. If you connect DAB unit, you can use DAB feature.
3. DAB unit is sold separately.

11. Service List display in each category (Preset / Ensemble / PTY)
12. Preset number/Channel number/Service number
13. DAB band button
14. Service List Update button
15. Service Link Mode button
16. Software version display

Seek Tuning

You can tune to the Ensemble and select the Service which is currently broadcast.

1. Touch the [PREV] or [NEXT] button to tune to previous or next ensemble station manually step by step.
2. Long touch the [PREV] or [NEXT] button to seek and tune to previous or next available ensemble station.
3. Touch [PREV] or [NEXT] button to select and tune to previous or next Service in current Ensemble.

Notes:

Total number and the current service number of the current Ensemble is displayed just below the Ensemble frequency display, as in the way "1/16".

Preset List/Service List Display

You can select the list from Preset List, Ensemble List or PTY List.

1. Touch the [Preset/Ensemble/PTY] button to select the list you want to display.
2. When you select "Preset", the list area displays preset services for each DAB Band. If you touch service in the list, you can listen to respective service in this list. If you touch and hold in the list, you can store current service in this list. Preset List will not be changed by Service Scan operation.
3. When you select "Ensemble", the list area displays Ensemble list which were stored by Service Scan. By selecting each Ensemble in the list, it will show the Services in this Ensemble. If you select "ALL Service", you can see all Services in all Ensembles. To go back to Ensemble list just touch "back" button.
4. When you select "PTY", the list area displays PTY category list from NEWS, SPORT, CULTURE, POP and OTHERS. By selecting each PTY in the list, it will show the Services in this PTY category. To go back to Ensemble list just touch "back" button.

Note:

If you want to update the services in Ensemble list and PTY list with current broadcasting, please perform Service Scan.



1. DAB Information display
2. Option button(open/close)
3. Preset Scan button
4. Previous Ensemble/Seek button
5. Next Ensemble/Seek button
6. Previous Service in Current Ensemble button
7. Next Service in Current Ensemble button
8. List Page Down button
9. List Page Up button
10. Preset List/Service List Switch button

Service Scan

When you want to update the list with the current services in Ensemble List or PTY List, please perform Service Scan.

1. Touch the option button  to open option menu display.
2. In Option Menu, touch the **[Start]** button.
3. Touch the **[OK]** button to start updating the service list, touch the **[Cancel]** button to cancel this operation then back to previous menu.

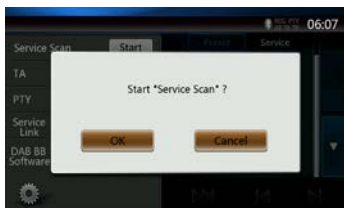

4. When scanning the services, this image will display.

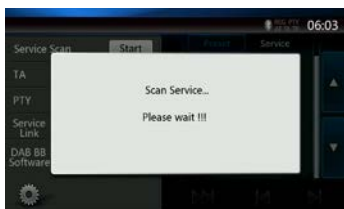

Notes:



After service scan, currently available services will be updated in the Ensemble List and PTY List.

DAB Band

When touch the DAB band button, the band will change as below DAB1->DAB2->DAB3->DAB1...

Preset Scan

Preset Scan tunes to the Services stored in the preset list in order.

1. Touch the [DAB1/2/3] button to select the desired band.)
2. Touch the  button to start the Preset Scan. The unit starts scanning each service for playing 10 seconds sequentially.
3. When the desired service is tuned in, touch the  button again to stay in that service.

Service Link Setting

You can select Service Link mode from On or OFF. If this setting is set to On, and current Service signal gets weak, it is to be linked to the service with better signal.

1. Touch the option button  to open option menu display.

1. Touch the  button to switch On or OFF.

Note:

Service Link is not currently supported in Australia.

18. HDMI MODE

Wire Connection of HDMI Mode

iPhone 4/4S/5/5s/5c can be connected by using the connector cable supplied with the iPhone 4/4S/5/5s/5c and HDMI cable (sold in the market) or CCA-770 and digital Av adapter.

Note:

The following is part of the wiring example.

Depending on the device, there is a case to connect to the device directly with the CCA-771.

Depending on the adapter or device, there is a case that the audio noise and video noise is generated.

(1) Connection with the iPhone 4/4S



NX404AU

HDMI cable sold in the market or *CCA-770

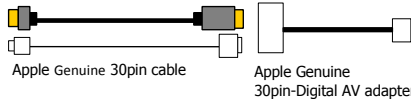

iPhone 4/4S

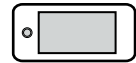

(2) Connection with the iPhone 5/5s/5c



NX404AU

HDMI cable sold in the market or *CCA-770

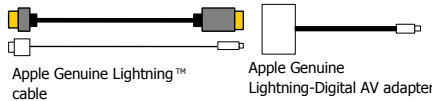

iPhone 5/5s/5c



(3) Connection with the Android Phone



NX404AU

Micro USB cable sold in the market

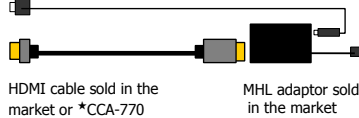

Android Phone



(4) Connection with the equipment with HDMI output

Electronic devices with HDMI output



NX404AU

HDMI cable sold in the market

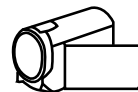

Select HDMI source



Touch the HDMI menu button, then appear the screen of the connected device.

This HDMI mode is only indicate the screen of the iPhone, Android. Can't operate by the touch screen of NX404AU

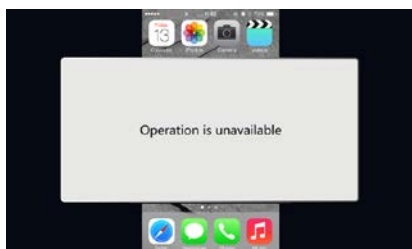

Note:

Depending on the application and model of the mobile phone, there is the case that black frame appears around the screen.

19. AUX

External peripheral devices, including a game console, camcorder, navigation unit, iPod/iPhone, etc. can be connected to the AUX connector on the front or back of this unit using the AVV media cables.

Switching to AUX IN

Touch [AUX1] / [AUX2] button on Main Menu to select desired mode (when unit is reading). If the external device connected to AUX input have audio signal, the unit will broadcast audio of external device. Touch Menu button on Operational Panel to return to the Main Menu.

You cannot directly control external devices connected to AUX input.



20. CAMERA INPUT OPERATIONS

Switching to Camera mode

Touch [Camera] button on Main Menu.

The LCD will display the external camera video. The screen will display "No Video Signal" message, if a valid camera is not connect to this head unit.

Touch MENU button on Operational Panel to return to the Main Menu.

Setting Camera audio

Select "On" button in the Camera Audio setting of the General setting.

The audio from camera will heard when back gear is on. The volume control is available but not indicated on the screen due to the safety.

Select "Mute" button, then mute the audio of the current mode when back gear is on.

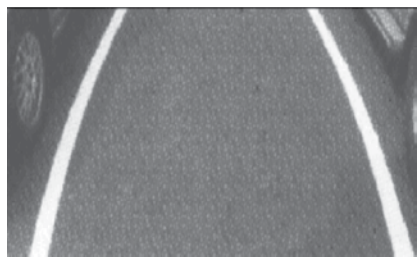
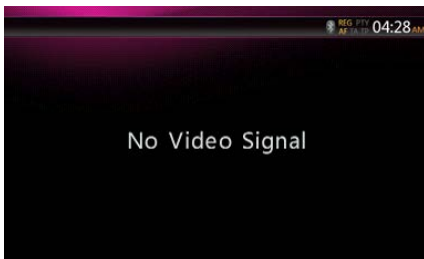

Note:

If the reverse cable is connected correctly to the car, this unit goes to camera mode automatically when the car is in reverse.

As an additional safety feature, the audio from camera with built-in microphones can be heard through the NX404AU.

21. REAR SOURCE OPERATIONS

If a monitor is installed in the rear zone and connected to the rear zone AV output, passengers in the back seat can watch the DVD/iPod Video/AUX1/ AUX2 video separately from front source.



1

1. Touch the button to access the front source.
Touch the button to close the rear source.

Multi-Zone Operation

Independent sources can be played simultaneously on the unit. For example, a FM/AM console can be played back on the front screen while DVD video is available to rear passengers. But now can't select DVD video in front.

Access Rear-Zone

1. Touch the Rear button on Main Menu to access the Rear Source.
2. Select a source to play.

Exit Rear-Zone

Touch the 2-Zone off button to close the Rear Source.

Note:

1. If the source is selected as the front, the source in rear can't be selected.
2. If the source is selected as the rear, the source in front can't be selected.
3. Touch the Front button to access the main menu but not close the Rear Source.

DVD Video in Rear

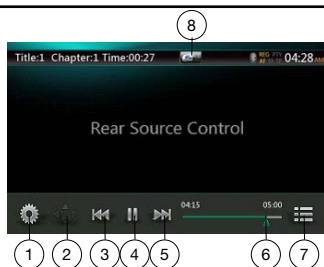

- 1 -Option button
- 2 -Show Cursor button
- 3 -Previous Chapter /Fast Backward button
- 4 -Play/Pause button
- 5 -Next Chapter /Fast Forward button
- 6 -Elapsed playing time
- 7 -Menu List button
- 8 -Front/Rear button

If the screen displays Rear Source, touch Front/Rear button to switch to Front Source.

If the screen displays Front Source, touch Front/Rear button to switch to Rear Source.



DVD Video Rear Source Control Information Mode.



Touch BACK button to return.

DVD Video Rear Source Control Direct Mode.



NOTE: More detail please refer to DVD Video Front source.

AUX1



AUX2



iPod Video Rear Source ID3 Mode

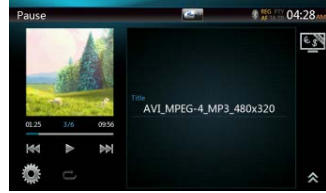
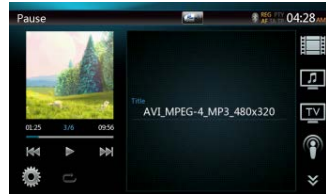

iPod Video in Rear

iPod Video Rear Source Control Play Mode



- 1 - Previous Track /Fast Backward button
- 2 - Play/Pause button
- 3 - Next Track/Fast Forward button
- 4 - Progress bar
- 5 - Menu list button:
 - Touch the Menu button to display the iPod Video Rear Source mode screen.
- 6 - Repeat button:
 - Same as iPod function of front source
- 7 - Front/Rear button
 - If the screen displays Rear Source, touch to switch to Front Source.
 - If the screen displays Front Source, touch to switch to Rear Source.

NOTE:

If the source is selected as the front, the source in rear can't be selected.

If the source is selected as the rear, the source in front can't be selected.

Touch the Front button to access the front main menu but the rear source will keep running.

TV in Rear

NOTE:TV FUNCTION DEPENDS ON THE LOCATION OF YOUR AREA. PLEASE CONSULT THE LOCAL SUPPLIERS.

- Enter

Touch the TV button on the Main menu display. The TV mode screen is displayed.

- Exit

Choose the other operations will exit TV mode.

Specific operations please consult the TV user manual. Different digital TV boxes include different operations.

22. SETTING OPERATIONS

Touch **[Setting]** button on the Main menu screen.
The Setting menu screen will be displayed.

General Setup Menu



System Language: Set the Language for system screen.

Illumination Color: Set the illumination color on the panel.

Select menu to be able to select from Shortcut menu and drag it to left side area.

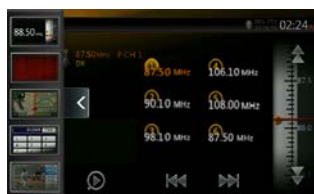
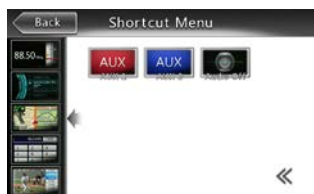

Time: Set system clock.

24-Hour Format: Set the time display mode.

Beep: Turn on or turn off the beep confirmation sound.

Bluetooth: Set the Bluetooth On or Off.

Wallpaper: Choose the desired wallpaper.



Input Aux Sense: AUX input switch, including Low, Middle, High.

DivX® Registration: Display the information about DivX® registration.

Tel Speaker: There are two options, Left and Right. For example, if current setting is Right, when BT phone is coming in, only right speaker can hear the phone.

Camera Audio: There are three options, Off, On and Mute.

Version: Display the software version information.

Note:

- Time and 24-Hour Format can be adjusted when set the system time not to be synchronized with GPS local time.

Video Setup Menu



This menu includes: DVD Wide Screen Mode; Dimmer. Dimmer Mode

DVD Wide Screen Mode: Set the DVD wide screen mode On or Off.

Dimmer: Set Dimmer value from 0 to 20.

Dimmer Mode: There are three options, Day, Night and Auto.

Audio Setup Menu



This menu includes: Balance, Fader, Beat EQ, Sub Woofer Ctrl, Sub Woofer Phase, High Pass Filter Low Pass Filter, Line Out and Magna Bass EX.

Balance: Choose the desired volume for left and right speaker.

Fader: Choose the desired volume for front and rear speaker.

Beat EQ: Choose the desired mode: Bass Boost, Impact, Excite, Custom and OFF.

Subwoofer Ctrl: Choose the desired subwoofer gain from 0 to 14.

Subwoofer Phase: Choose the Subwoofer Phase normal or reverse.

High Pass Filter: Choose the frequency about the high pass filter or enable. The frequencies include 60Hz, 90Hz and 120Hz.

Low Pass Filter: Choose the frequency about the low pass filter or enable. The frequencies include 60Hz, 90Hz and 120Hz.

Magna Bass EX: Choose the loudness On or Off.

Navigation Setup Menu

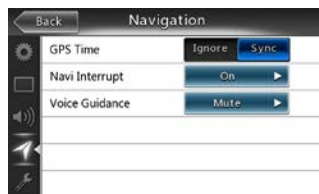

This menu includes: GPS Time, Navi Interrupt, Voice Guidance.

GPS Time: Set the system time to be synchronized with GPS local time or not.

Navi Interrupt: There are three choices: On/Popup/ Off. "On": The navigation screen will cover to AV screen when reaching some button point. "Popup": When small turn info window will pop up in the top of the AV screen to indicate the button point. "Off": Turn off this function.

Voice Guidance: There are three choose: On/Mute/ Off.

On: Interrupt function of voice guidance is on. While interrupting no attenuate function of AV sound.

Mute: Interrupt function of voice guidance is on. While interrupting attenuate function sound is on.

Off: Disable the navigation voice guidance.

Others Setup Menu



This menu include: Set Password; Parental Control; Audio Language; Subtitle Language; blinking LED; DAB/TV(Optional); Screen Calibration and Factory Default.

Set Password: Set the password for DVD parental control.

Parental Control: Set the rating of the age. It contains Kid Safe/G/PG/PG- 13/PG-R/R/NC- 17/Adult.

Audio Language: Set the Language for DVD Audio.

Subtitle Language: Set the Language for DVD subtitle.



Blinking LED: Set blinking LED On or Off.

DAB/TV(Optional): Set the mode DAB/TV/Off

Screen Calibration: The function of it is to select the TS Calibrate YES or NO.

Factory Default: The function is to select to load factory default or not.

Set the Anti-Theft code

1. If your unit is unlocked, hold the  button more than 2 seconds, then the Anti-Theft setting mode will display. Users can change anti-theft code.
Touch [YES], the numerical keypad is displayed.
Enter the new password twice, then anti-theft code is set and your unit is secured.
When the Anti-theft is "On", you need enter correct Anti-theft code to turn the unit on. If you enter wrong code three times, the unit is locked, and must be unlocked by the professionals.
2. If your unit is secured, hold the  button more than 2 seconds, then the Anti-Theft setting mode will display. The numerical keypad is displayed, enter the right code to unlock.

Note:

If the anti-theft code is lost or forgotten, a charge will be incurred at the owner's expense by a Clarion service station to unlock the NX404AU.

23. TROUBLESHOOTING

GENERAL

Problem	Cause	Measure
Power does not turn on. (No sound is produced.)	Fuse is blown.	Replace with a fuse of the same amperage. If the fuse blows again, consult your store of purchase.
	Incorrect wiring.	Consult your installation center.
Nothing happens when buttons are touched. Display is not accurate.	The microprocessor has malfunctioned due to noise, etc.	Touch the reset button with a thin rod. Note: <i>When the Reset button is touched, turn off the ACC power.</i> * When the Reset button is touched, frequencies of radio stations, titles, etc. stored in memory are cleared.
The remote control unit does not work.	Direct rays of the sun fall on the light-receptive part of the remote control unit.	When direct rays of the sun fall on the light-receptive part of the remote control unit, it may not work.
	The battery of the remote control unit is dead or there is no battery in the remote control unit.	Check the battery of the remote control unit.

DVD PLAYER

Problem	Cause	Measure
Disc cannot be loaded.	A disc is already loaded.	Eject the disc before loading the new one.
	There is foreign matter already in the disc slot.	Remove the foreign matter, or consult a service station.
Sound skips or is noisy.	Disc is dirty.	Clean the disc with a soft cloth.
	Disc is heavily scratched or warped.	Replace with a disc in good condition.
Sound is bad directly after power is turned on.	Condensation may form on the internal lens when the car is parked in a humid place.	Let dry for about 1 hour with the power on.
Video images are not displayed.	The parking brake is not engaged.	Check that the parking brake is engaged.
Disc cannot play with the display " PARENTAL VIOLATION " shown.	Feature exceeds set parental level.	Release the view limitation or change the parental level. See the subsection "Setting up the parental level"

USB DEVICE

Problem	Cause	Measure
USB device cannot be inserted.	The USB device has been inserted with wrong direction.	Reversing the connection direction of the USB device, try it again.
	The USB connector is broken.	Replace with a new USB device.
USB device is not recognized.	The USB device is damaged.	Disconnect the USB device and reconnect. If the device is still not recognized, try replacing with a different USB device.
	Connectors are loose.	
No sound heard with the display "NO FILE" shown.	No MP3/WMA file is stored in the USB device.	Store these files properly in the USB device.
Sound skips or is noisy.	MP3/WMA files are not encoded properly.	Use MP3/WMA files encoded properly.
The video image of iPod/iPhone is disturbed.	The TV Signal setting of the iPod/iPhone is not set correctly.	Set the TV Signal setting (NTSC/PAL) of the iPod/iPhone correctly.

Bluetooth

Problem	Cause	Measure
Cannot pair the Bluetooth enable device with the car audio system.	The device does not support the profiles required for the system.	Use another device to connect.
	The Bluetooth function of the device is not enabled.	Refer to the user manual of the device for how to enable the function.
The audio quality is poor after connection with a Bluetooth enabled device.	The Bluetooth reception is poor.	Move the device closer to the car audio system or remove any obstacle between the device and the system.

TFT screen

Problem	Cause	Measure
The image is not displayed.	The parking brake is not engaged.	Check that the parking brake is engaged.
The display is dark.	The Dimmer control is too low.	Adjust the Dimmer properly.
	The operating condition is not good.	The temperature inside the vehicle may be 0°C or lower. Set to an appropriate temperature (25°C or so) and check it again.
	The headlight of the vehicle is lit	The display is made dark at night to prevent the glare (When the headlight of the vehicle is lit in the daytime, the display gets dark).
There are red, green, and blue points in display.	-----	This is not a failure, but a phenomenon peculiar to a liquid crystal panel (The liquid crystal panel is produced according to technology with very high precision. Note that, though there are effective pixels of 99.99% or more, pixel missing or normally lit pixels account for 0.01%).

24. ERROR DISPLAY

If an error occurs, one of the following displays is displayed.
Take the measures described below to solve the problem.

DVD PLAYER

Display	Cause	Measure
BAD DISC	A disc is caught inside the DVD deck and is not ejected.	This is a failure of DVD deck's mechanism and consult your store of purchase.
BAD DISC	A disc cannot be played due to scratches, etc.	Replace with a non-scratched, non-warped disc.
BAD DISC	A disc is loaded upside- down inside the DVD deck and does not play.	Eject the disc then reload it properly.
PARENTAL VIOLATION	Parental level error	Set the correct Parental level.
Disc Region incorrect	Region code error	Eject the disc, and replace correct region code disc.

25. SPECIFICATIONS

FM Tuner

Frequency Range: 87.5 MHz to 108.0 MHz

Usable Sensitivity: 8 dB μ V

Stereo Separation: 25 dB (1 kHz)

Frequency Response: 30 Hz to 14 kHz

A2DP (Advanced Audio Distribution Profile)

AVRCP1.2,1.3,1.4 (AV Remote Control Profile)

PBAP (Phone Book Access Profile)

SPP (Serial Port Profile)

Power Class: 2

AM Tuner

Frequency Range: 531 kHz to 1,629 kHz

Usable Sensitivity: 30 dB μ V

USB

Specification: USB 1.1/2.0 (FS)

Playable Audio format:

MP3,WMA,AAC,FLAC

Playable Video format:

AVI,MP4,MPG/MPEG,3gp

DVD Player System

Digital Versatile Disc System with CDDA capable

Usable discs:

DVD video disc, Compact disc

Frequency Response: 20 Hz to 20 kHz

Signal/Noise Ratio: 93 dbA

Distortion: 0.05%

Video system: NTSC/PAL

General

Power source voltage:

14.4 VDC (10.8 to 15.6 V allowable)

Ground: Negative

Current consumption: 4.0 A @1 W

Auto Antenna Rated Current: 500 mA less

Audio/Video Input

Audio input voltage: $\leq 2 V_{rms}$

Video input voltage: $1.0 V_{p-p}@75\Omega$

Audio input sensitivity (at 2 V output)

High: 325 mV $_{rms}$

Mid: 650 mV $_{rms}$

Low: 1.3 V $_{rms}$

Audio Amplifier

Maximum power output:

180W (45W x 4)

Speaker impedance 4Ω (4 to 8Ω allowable)

Output power:

4 x 25W DIN 45324,+B=14.4V

Audio/Video output

Video output voltage: $1.0 V_{p-p}@75\Omega$

Screen Size: 6.2" wide type

Pixels: 1,152,000

Resolution: 800 x 480 x 3 (RGB)

Bluetooth

Specification: Bluetooth Ver 2.1+EDR

Profile: HFP1.5(Hands Free Profile)

HSP1.0 (Headset Profile)

Note:

- Specifications and design are subject to change without notice for further improvement.

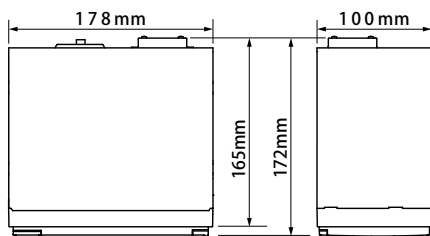

NX404AU dimensions:

NX404AU weight: 2.3 kg

Symbol Identification

This manual uses symbols and icons to indicate safety precautions and concerns during the installation procedure. Be sure to carefully read and understand each precaution prior to beginning the installation.

WARNING

This symbol is intended to alert the user to the presence of important operating instructions. Failure to heed the instructions may result in severe injury or death.

CAUTION

This symbol is intended to alert the user to the presence of important operating instructions. Failure to heed the instructions can result in injury or material damage.

WARNING

- Confirm the battery voltage of the vehicle to be installed. This unit is designed only for vehicles with DC 12V power supply.
- Disconnect the negative terminal of the battery before connecting wires, otherwise an electric shock, injury by short circuit may occur.

Installation Precautions

WARNING

- When installing the unit to a vehicle with an airbag system, never install it in a place where it may affect the operation of the airbag.
- Do not install this unit in the following locations:
 - A location interfering with the driver's visual range or operation.
 - A location where the gear shift or brake pedal are hindered.
 - A location where passengers are at risk.
 - An unstable location, or where the system may fall.

CAUTION

- Do not install the system in the locations described below. This may cause a fire, accident or electrical shock:
 - A location exposed to rain or dust.
 - An unstable location, or where the system may fall.
- Do not install this unit in a place exposed to direct sunlight, heat or a place where the vent holes or heat radiation holes are covered.
- When you install the antenna, mount it in a place where the elements of the antenna do not protrude beyond the edge of the front, back, left and right of the vehicle. If it comes in contact with pedestrians, it may cause an accident.

Installation Notes

WARNING

- Please note the position of pipes, tanks and electrical wirings before installing the unit into the vehicle; failure in avoiding these may cause a fire or malfunction.

⚠ CAUTION

- Use only the supplied parts.
If unspecified parts are used, they may cause damage.
- Any holes made in the body of the vehicle should be sealed with a silicon adhesive. If exhaust fumes or water penetrates into the vehicle, this may cause an accident.
- Fasten the bolts securely when installing the unit. If the bolts are loose an accident or malfunction could occur.

Connection Notes**⚠ WARNING**

- Loom all cables according to the instruction manual, so as not to hinder operation.
- Wire the connecting cords/cables away from high temperature areas. If the coatings of the cables melt, it could cause an accident/fire by a short circuit. Take care when wiring in the engine compartment.
- When wiring the connecting cables in a vehicle with an airbag system, never feed the cables through a place where it may affect the operation of the airbag. An airbag not operating correctly in an emergency may cause increased injury.

⚠ CAUTION

- Verify wires with a digital multi-meter prior to making any connections. Many new vehicles use multiplexed and/or low voltage circuits that can be damaged if a test light or logic probe is used.
- Connect cables appropriately. If a wrong connection is made, this may cause a fire or accident.

- When passing cables through the body of the vehicle, use non-conductive grommets. If the coatings of the cables are worn out by rubbing, this may cause an accident, fire or a short circuit.
- After wiring cables, fix them with insulation tape.
- Be sure to switch off the vehicle when connecting or disconnecting cords to/from the unit, otherwise an electric shock, injury or accident may occur.

INSTALLATION

CONTENTS

1. Before Starting.....	28
2. Package Contents	28
3. General Cautions	28
4. Cautions On Installation.....	28
5. Installing The Main Unit.....	29

1. Before Starting

1. This set is exclusively for use in cars with a negative ground 12 V power supply.
2. Read these instructions carefully.
3. Be sure to disconnect the battery “-” terminal before starting. This is to prevent short circuits during installation. (Figure1)

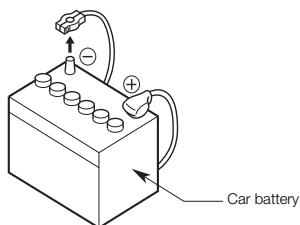

Figure 1

2. Package Contents

Main unit	1
Wiring harness	1
GPS antenna	1
Clamp for GPS antenna's cable	3
Double face tape for GPS Antenna.....	1
Owner's manual and Installation manual.....	1
HDMI cable holder.....	1
Machine screw(M2.6 x 4).....	2
RCA output cable.....	1
Electro tap.....	2
Flush mount bolts	8
Hexagon Head Screw.....	8

3. General Cautions

1. Do not open the case. There are no user- serviceable parts inside. If you drop anything into the unit during installation, consult your dealer or an authorized Clarion service center.
2. Use a soft, dry cloth to clean the case. Never use a rough cloth, thinner, benzene, or alcohol etc. For tough dirt, apply a little cold or warm water to a soft cloth and wipe off the dirt gently.

4. Cautions on Installation

1. Prepare all articles necessary for installing the source unit before starting.
2. Install the unit within 30° of the horizontal plane. (Figure 2)
3. If you have to do any work on the car body, such as drilling holes, consult your car dealer beforehand.
4. Use the enclosed screws for installation. Using other screws can cause damage. (Figure 3)

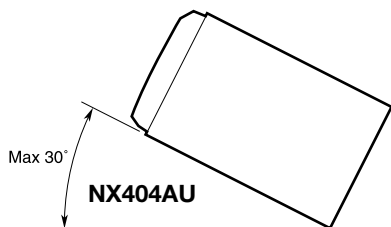

Figure 2

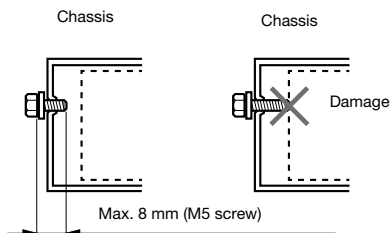
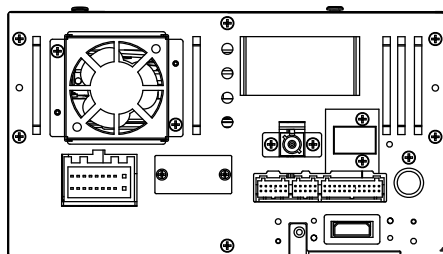

Figure 3

5. This unit has a fan motor in the back of the main unit so as not to raise the temperature in the source unit. When the fan motor vent is covered with cords or mounting bracket, it may cause a malfunction. Be sure not to cover it when wiring cords.



5. Installing the Main Unit

This unit is designed for fixed installation in the dashboard.

1. When installing the main unit in NISSAN vehicles, use the parts attached to the unit and follow the instructions in Figure 5.

When installing the main unit in TOYOTA vehicles, use the parts attached to the vehicle and follow the instructions in Figure 6.

2. Wire as shown in WIRE CONNECTION GUIDE .

3. Reassemble and secure the unit in the dashboard and set the face panel and center panel

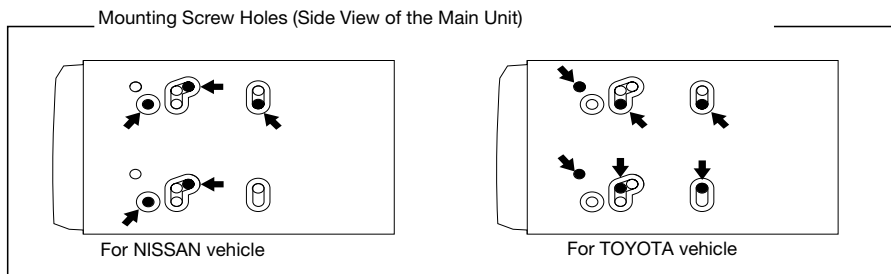

Figure 4

Installing the Main Unit in NISSAN Vehicle

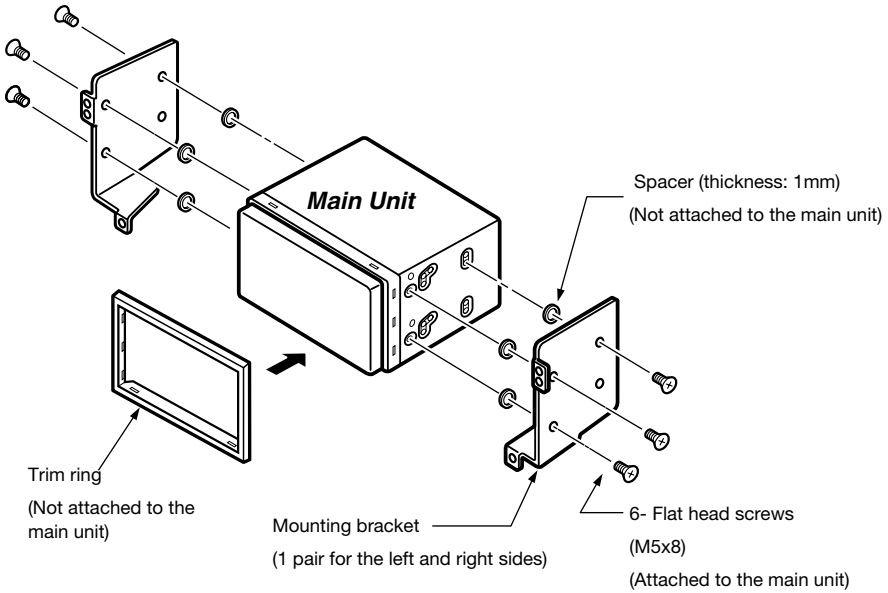

Figure 5

Vehicles other than NISSAN and TOYOTA

In some cases the center panel may require modification. (Trimming, filing, etc.)

- Removing the Main Unit

When the main unit is to be removed, disassemble it in the reverse of the order in

“5. Installing the Main Unit”

Installing the Main Unit in TOYOTA Vehicle

Install by using parts attached to the vehicle. (Screws marked ★ are attached to the vehicle.)

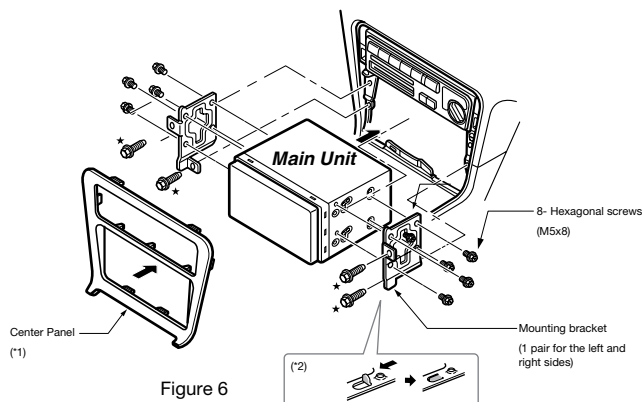

*1. Some panel openings are too small for the unit depending on the vehicle type and model. In such a case, trim the upper and lower sides of the panel frame by about 0.5 to 1.5 mm so the unit can be inserted smoothly.

*2. If a hook on the installation bracket interferes with the unit, bend and flatten it with a nipper or similar tool.

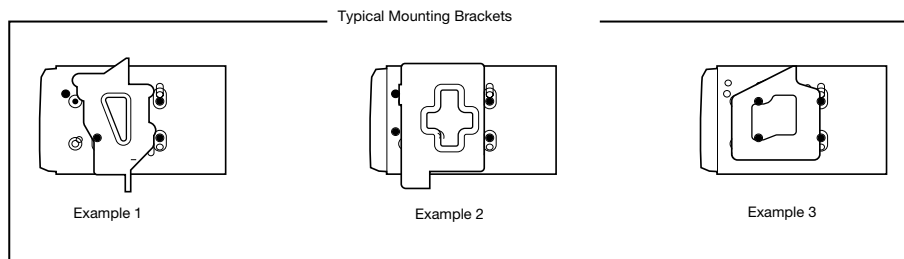

Affix the screws to the ● marks.

WIRE CONNECTION GUIDE

Note:

- Before installing, be sure to disconnect the negative cable of the car battery.
- In the optional devices, the RCA cables and the Connector cables are separately-sold items.
- When connect the HDMI cable, be sure to fix with the HDMI cable holder and Machine screw(M2.6 x 4).

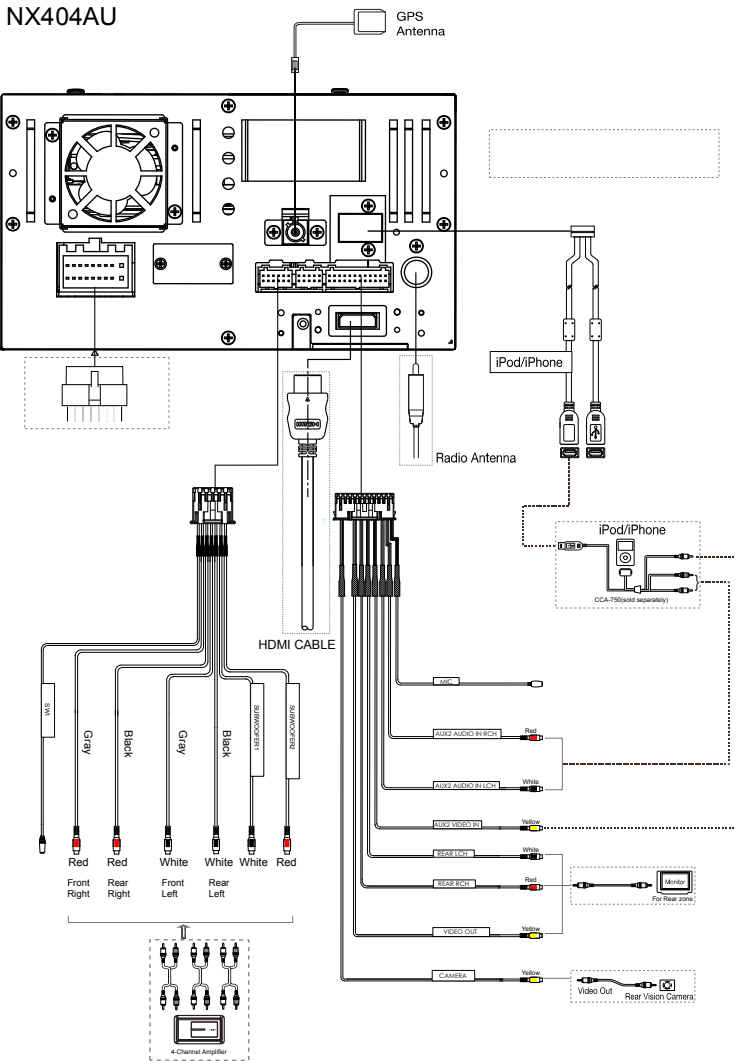

Installing The GPS Antenna

WARNING

- Do not install the GPS antenna in a place where it may interfere with the operation of the airbag or hinder the driver's visual range.
- Do not use the navigation system with the GPS antenna cord cut off. The power cables in the cord may be short-circuited.

Note:

- The supplied GPS antenna is for installing inside the vehicle. Do not install it outside the vehicle.
- Install the GPS antenna more than 50 cm away from the main unit, other audio devices such as CD player, and a radar detector. If it is installed near these devices, GPS reception may be impaired.
- To improve the GPS signal reception, install the GPS antenna horizontally on a flat plane.
- Do not wax or paint the cover of the GPS antenna. This may reduce the performance of the GPS antenna.
- Install the GPS antenna at least 10 cm away from the windshield.
- Wipe off the dirt of the mounting surface before installing the GPS antenna.

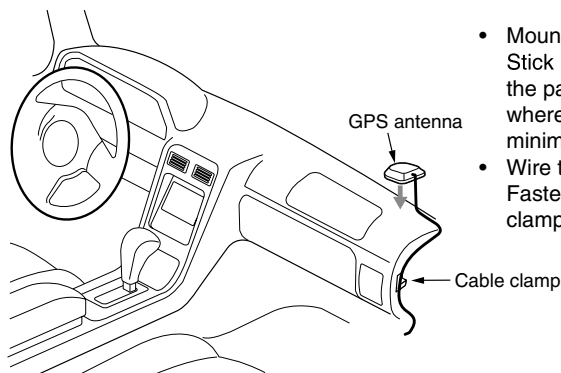

- Mount the GPS antenna. Stick it surely on a flat plane of the passenger side dashboard where GPS signal interruption is minimized.
- Wire the GPS antenna cord. Fasten the cord using the Cable clamps.

Figure 7

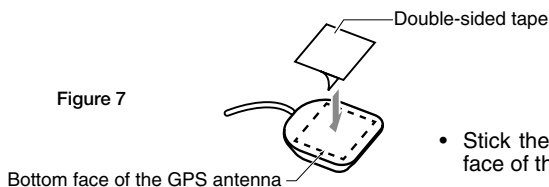

- Stick the double-sided tape to the bottom face of the GPS antenna.

Cautions on Wiring

1. Be sure to turn the power off before wiring.
2. Be particularly careful where you route the wires.

Keep them well away from the engine, and exhaust pipe, etc. Heat may damage the wires.

3. If the fuse should blow, check to see if the wiring is correct.

If a fuse is blown, replace it with a new one of the same amperage rating as the original (15A FUSE).

4. To replace the fuse, remove the old fuse on the back of the unit and insert the new one. (Figure 8)

NOTE:

There are various types of fuse holder. Do not let the battery side touch other metal parts.

⚠ CAUTION

After the connection, fix the cord by a clamp or insulation tape for protection.

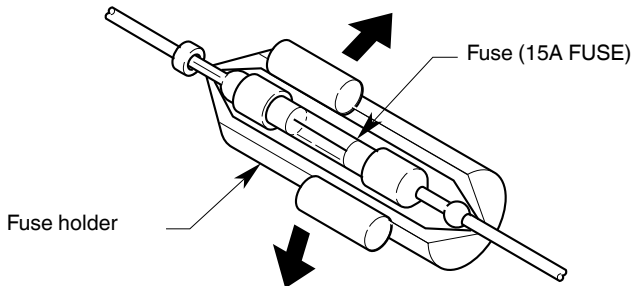
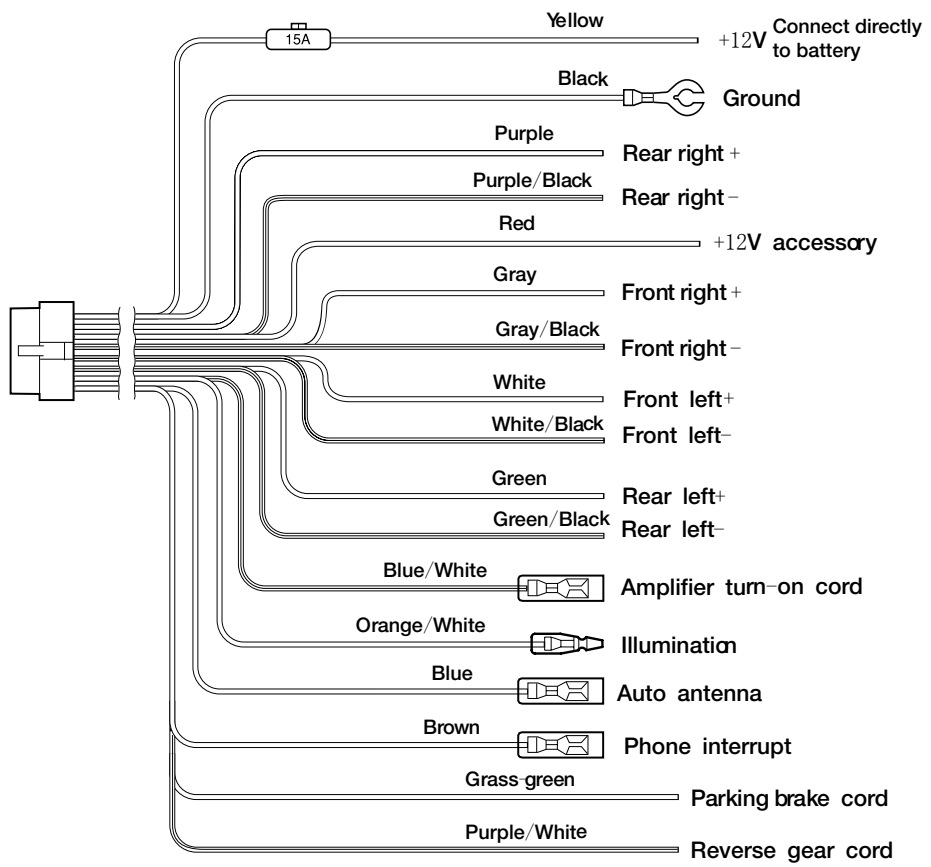

Figure 8



Note:

**1: Connecting the PHONE INTERRUPT terminal
 The phone interrupt will mute the audio if the lead receives a negative or ground signal.*

Connecting the parking brake cord

Connect the cord to parking brake lamp ground in the meter panel.

Note:

- Connecting the parking brake cord to lamp ground allows you to watch iPod/iPhone video/DVD video/AV input when the parking brake is engaged.
- When the parking brake cord is not connected, the monitor will not show any video sources.
- If "AUDIO ONLY" appears on the screen just after turning on the ACC power of the car, release the parking brake while confirming safety, and then engage the parking brake again.

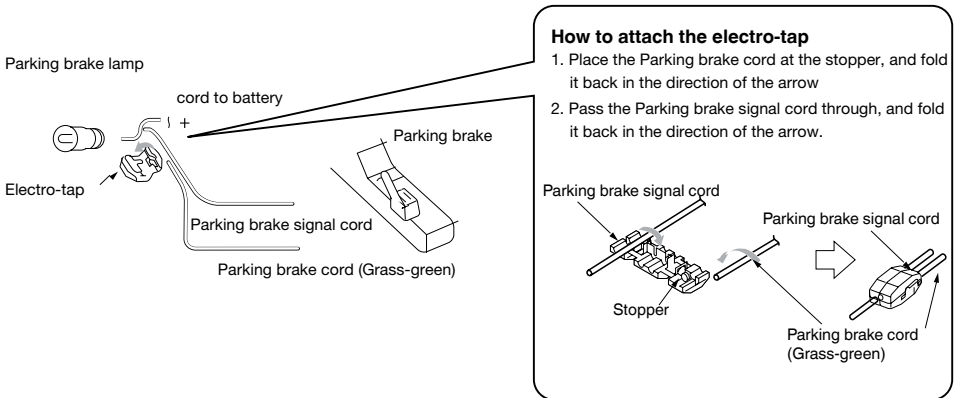

Clarion Co., Ltd.

All Rights Reserved. Copyright © 2014: Clarion Co., Ltd.