

clarion®

Owner's manual & Installation manual

NX501A

**2-DIN DVD MULTIMEDIA STATION WITH
BUILT-IN NAVIGATION & 6.2" TOUCH PANEL CONTROL**

1. FEATURES.....	5
Expanding Systems	5
2. PRECAUTIONS.....	6
3. CAUTIONS ON HANDLING.....	8
Operation Panel	8
USB Port	8
Cleaning	8
Handling Discs	9
4. PANEL CONTROLS.....	10
NX501A Functions of Buttons	10
5. REMOTE CONTROL.....	11
Functions of Remote Control Buttons	12
6. MAIN MENU OPERATIONS.....	14
Front Zone Source.....	14
Rear Zone Source.....	14
7. DVD SYSTEM	15
DVD Video Features.....	15
Discs	15
About the registered marks, etc.	16
8. DVD VIDEO PLAYER OPERATIONS	17
Change DVD System Settings	17
Watching to a disc	18
Operate the DVD Player menu.....	18
Operate the Video files Player menu.....	21
9. DVD AUDIO PLAYER OPERATIONS.....	22
Showing CD Player mode screen	22
Operate the CD Player menu.....	22
Listening To MP3/WMA.....	23
10. USB AUDIO OPERATIONS	26
Notes on using USB memories.....	26
Select USB Audio mode	26
Playing MP3/WMA files in USB memory	27
11. USB VIDEO OPERATIONS.....	29
Notes on using USB memories.....	29
Select USB Video mode	29
Playing video files in USB memory.....	29
USB Video Menu Operations.....	30
12. iPod/iPhone OPERATIONS	31
Notes on using Apple iPod/iPhone.....	31
Controlling the iPod/iPhone	31
Selecting the iPod Video mode	33
13. Bluetooth AUDIO PLAYER OPERATIONS.....	35
Selecting the Bluetooth Audio mode	35
Bluetooth audio player settings	35
Registering your Bluetooth audio player (Pairing).....	35
Selecting the Bluetooth audio player.....	36
Controlling the Bluetooth audio player	36
14. Bluetooth TELEPHONE OPERATIONS	37
Select the BT Phone mode.....	37
Bluetooth Telephone settings	37
Register your cellular phone (Pairing)	38
Select the cellular phone	39
Obtaining the Phone Book data	39
Telephone operations	39

15. RADIO OPERATIONS	41
16. RDS OPERATIONS	42
17. AUX 1 / AUX 2 OPERATIONS	45
18. CAMERA OPERATIONS	45
19. REAR SOURCE OPERATIONS	46
DVD Video in Rear	46
AUX 1 in Rear.....	47
AUX 2 in Rear.....	47
iPod Video in Rear	47
20. SETTING OPERATIONS	48
General Setup Menu	48
Video Setup Menu	48
Audio Setup Menu	48
Navigation Setup Menu	49
Others Setup Menu.....	49
Set the Anti-Theft code.....	49
21. MONITOR OFF	50
22. TROUBLESHOOTING	51
GENERAL.....	51
DVD PLAYER	51
USB DEVICE	52
Bluetooth	52
TV/VTR (When connecting an optional TV tuner, etc.).....	53
23. ERROR DISPLAY	53
24. SPECIFICATIONS	54
INSTALLATION / WIRE CONNECTION GUIDE	56

1. FEATURES

- Double Din 6.2" Touch Panel Control
- DVD Video/CD-DA/MP3/WMA Playback Capability
- Built-In Bluetooth®
- OEM Steering Wheel Remote Ready
- Compatible with iPod® / iPhone® via USB

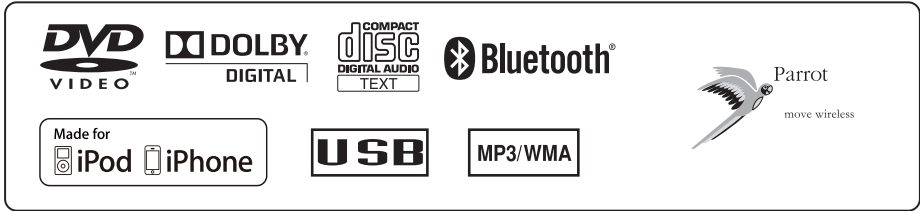

Expanding Systems

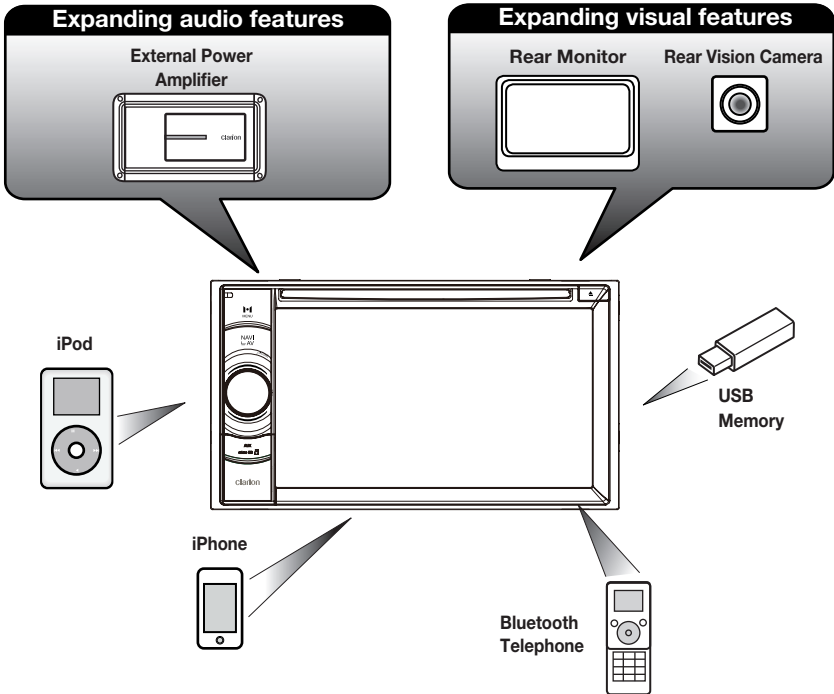

NOTE:

The items listed outside the frames are the commercial products generally sold.

2. PRECAUTIONS

WARNING

- For your safety, the driver should not watch any video sources and/or operate the controls while driving. Please note that watching and operating any video sources while driving are prohibited by law in some countries. Also, while driving, keep the volume to a level at which external sounds can be heard.
- When using the navigation system, follow the precautions listed below. After reading this manual, be sure to keep it in a handy place (such as the glove box of your car).
- This navigation system should not be used to replace your own judgment. No itinerary suggested by this navigation system should ever override any highway regulations, your own judgment, or a knowledge of safe driving practices. Do not follow the navigation system's suggested itinerary if it would cause you to perform a dangerous or illegal act, place you in a dangerous situation, or take you into an area you consider unsafe.
- The advice provided by the navigation system is to be regarded as a suggestion only. There may be times when the navigation system displays the vehicle's location incorrectly, fails to suggest the shortest route, or fails to direct you to your desired destination. In such instances, rely on your own driving judgment, taking into account the driving conditions at the time.
- Do not use the navigation system to locate emergency services. The database does not contain a complete listing of emergency services such as police stations, fire halls, hospitals and walk-in clinics. Please show discretion and ask for directions in such instances.
- As the driver, you alone are responsible for your driving safety.
- In order to avoid a traffic accident, do not operate the system while driving.
- In order to avoid a traffic accident, operate the system only when the vehicle is stopped at a safe place and the parking brake is on.
- In order to avoid a traffic accident or traffic offense, remember that actual road conditions and traffic regulations take precedence over the information contained on the navigation system.
- The software may contain inaccurate or incomplete information due to the passage of time, changing circumstances, and the sources of information used. Please respect current traffic conditions and regulations at all times while driving.
- Where actual road conditions and highway regulations differ from the information contained on the navigation system, abide by the highway regulations.
- Keep the amount of time spent viewing the screen while driving to a strict minimum.
- The navigation system does not provide, nor represent in any way information on: traffic and highway regulations; technical aspects of the vehicle including weight, height, width, load and speed limits; road conditions including grade, percentage of incline and surface conditions; obstacles such as the height and width of bridges and tunnels; and other current driving or road conditions. Always rely on your own judgment when driving a car, taking into account current driving conditions.
- Do not disassemble or modify this unit. It may cause an accident, fire, or electric shock.
- Do not use this unit when a trouble exists, such as no screen content appears or no sound is audible. It may cause an accident, fire, or electric shock. For that case, consult your authorized dealer or a nearest Clarion service center.
- In case of a problem, such as any material has been entered in the unit, the unit gets wet, or smoke or strange smells come out of the unit, etc., stop using this unit immediately, and consult your authorized dealer or a nearest Clarion service center.
Using it in that condition may cause an accident, fire, or electric shock.
- Use a fuse with the same specification only when replacing the fuse.
Using a fuse with a different specification may cause a fire.
- For the installation of this unit or a change in the installation, ask your authorized dealer or a nearest Clarion service center for safety. Professional skills and experiences are required to do so.
- Rear View Camera Warning:
For your safety, the driver should not view the Reversing Cameras while travelling in a forward direction, which is prohibited according to Australian Road Laws.
Clarion strongly recommends that when installing a Reverse Camera to this product, the camera's power source be derived from the vehicles reversing lamp circuit either directly (if suitable) or via a relay. This will ensure that the Rear View Camera can only be viewed while the vehicle is travelling in a reverse direction.

1. When the inside of the car is very cold and the player is used soon after switching on the heater, moisture may form on the disc (DVD/CD) or the optical parts of the player and proper playback may not be possible. If moisture forms on the disc (DVD/CD), wipe it off with a soft cloth. If moisture forms on the optical parts of the player, do not use the player for about one hour. The condensation will disappear naturally allowing normal operation.
2. Driving on extremely bumpy roads which cause severe vibration may cause the sound to skip.
3. This unit uses a precision mechanism. Even in the event that trouble arises, never open the case, disassemble the unit, or lubricate the rotating parts.

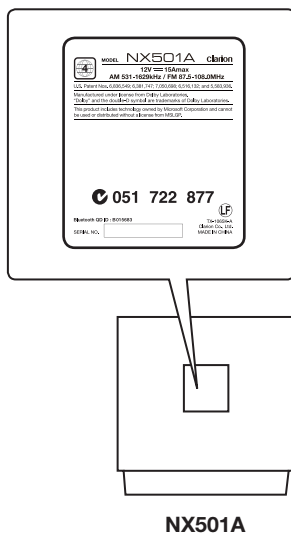

3. CAUTIONS ON HANDLING

Operation Panel

For a longer service life, be sure to read the following cautions.

- The operation panel will operate properly in a temperature range of 0° to 60° C.
- Do not allow any liquids on the set from drinks, umbrellas etc. Doing so may damage the internal circuitry.
- Do not disassemble or modify the set in any way. Doing so may result in damage.
- Subjecting the operation panel to shocks may result in breakage, deformation or other damage.
- Do not let cigarettes burn the display.
- If a problem should occur, have the set inspected at your store of purchase.
- Do not poke or insert objects in the CD/DVD slot, microSD card slot or the front AUX input.
- The remote control unit may not work if the remote control sensor is exposed to direct sunlight.
- In extremely cold weather, the display movement may slow down and the display may darken, but this is not a malfunction. The display will work normally when the temperature increases.
- Small black and shiny spots inside the liquid crystal panel are normal for LCD products.

USB Port

- The USB memory stick may stick out when inserted, so it may cause danger during driving. In such cases, you can use a commercial USB extension cable, etc., but use it safely under your own judgment.
- The USB memory sticks must be recognized as "USB mass storage class" to work properly. Some models may not operate correctly.
When the memorized data is lost or damaged by any chance, Clarion shall not be liable for any damage.
When using an USB memory stick, we recommend that you backup your data stored on it before by using a personal computer etc.
- Data files may be broken when using USB memory sticks in the following situation:
 - When disconnecting the USB memory stick or turning the power off during writing or reading data. When affected by static electricity or electric noise. Connect/disconnect the USB memory stick when it is not accessed.
 - Some USB memory sticks cannot be inserted to the main unit because of their shape. In such cases, use a commercial USB extension cable to connect them.
 - Connecting with the computer is not covered.
 - Music files (MP3, WMA, etc.) stored in the USB memory stick can be played back.

Cleaning

- **Cleaning the cabinet**
Use a soft, dry cloth and gently wipe off the dirt. For tough dirt, apply some neutral detergent diluted in water to a soft cloth, wipe off the dirt gently, then wipe again with a dry cloth.
Do not use benzene, thinner, car cleaner, etc., as these substances may damage the cabinet or cause the paint to peel. Also, leaving rubber or plastic products in contact with the cabinet for long periods of time may cause stains.
- **Cleaning the liquid crystal panel**
The liquid crystal panel tends to collect dust, so wipe it off occasionally with a soft cloth. The surface is easily scratched, so do not rub it with hard objects.

Handling

- New discs may have some roughness around the edges. If such discs are used, the player may not work or the sound may skip. Use a ball-point pen or the like to remove any roughness from the edge of the disc.

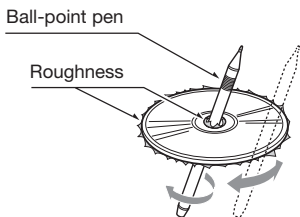

- Never stick labels on the surface of the disc or mark the surface with a pencil or pen.
- Never play a disc with any cellophane tape or other glue on it or with peeling off marks. If you try to play such a disc, you may not be able to get it back out of the DVD player or it may damage the DVD player.
- Do not use discs that have large scratches, are misshapen, cracked, etc. Use of such discs may cause misoperation or damage.
- To remove a disc from its storage case, press down on the center of the case and lift the disc out, holding it carefully by the edges.
- Do not use commercially available disc protection sheets or discs equipped with stabilizers, etc. These may damage the disc or cause breakdown of the internal mechanism.

Storage

- Do not expose discs to direct sunlight or any heat source.
- Do not expose discs to excess humidity or dust.
- Do not expose discs to direct heat from heaters.

Cleaning

- To remove fingermarks and dust, use a soft cloth and wipe in a straight line from the center of the disc to the circumference.
- Do not use any solvents, such as commercially available cleaners, anti-static spray, or thinner to clean discs.
- After using special disc cleaner, let the disc dry off well before playing it.

On Discs

- Exercise a good precaution when loading a disc. The operation panel will close automatically when leaving it open for a while.
- Never turn off the power and remove the unit from the car with a disc loaded.

CAUTION

For your safety, the driver should not insert or eject a disc, opening the operation panel while driving.

4. PANEL CONTROLS

NX501A Functions of Buttons

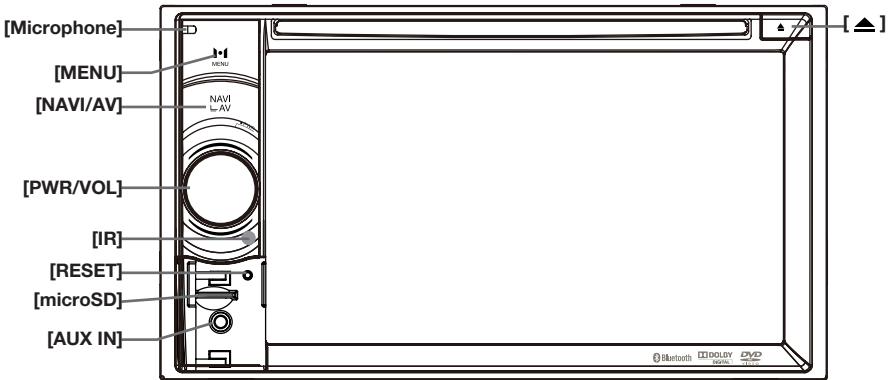

Note: Be sure to read this chapter while referring to front diagram "PANEL CONTROLS".

[PWR/VOL] Knob

- Press this key to power on the system in power off mode.
- When the power is already on, it moves to the Navigation mode. If Navigation mode is displayed it moves to the Navigation menu.
- Keep pressing this key more than 2 second to turn off the system when system is in power on mode.
- Rotate the knob to increase or decrease the volume.

[NAVI/AV] Button

- Press this button to enter navigation mode; press again to return current source.
- Press and hold this button for 3 seconds to display the brightness setting panel.

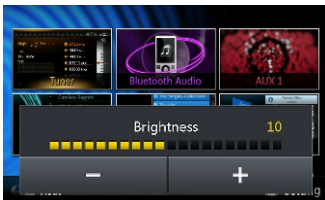

[▲] Eject

- Press to eject disc from unit.

[MENU] Button

- Press this button to display main menu, press again to return current source.

- Press and hold this button for 3 seconds to turn off the monitor. Press any place of the screen to turn on the monitor again.

[RESET] Button

- Press this button to hardware reset the unit.

Note: When the [RESET] button is pressed, frequencies of radio stations, titles, etc. stored in memory are cleared.

[microSD]

- Insert a microSD in this.

Note: The microSD card is only for navigation. Please don't remove it, otherwise, the navigation function will be disabled.

[AUX IN]

AUX 1 Connector.

[Microphone]

- Internal microphone for use during Bluetooth phone calls. Sensitivity can be adjusted from the Settings menu.

[IR] SENSOR

- Receiver for the remote control unit (operating range: 30 degree in all directions).

5. REMOTE CONTROL

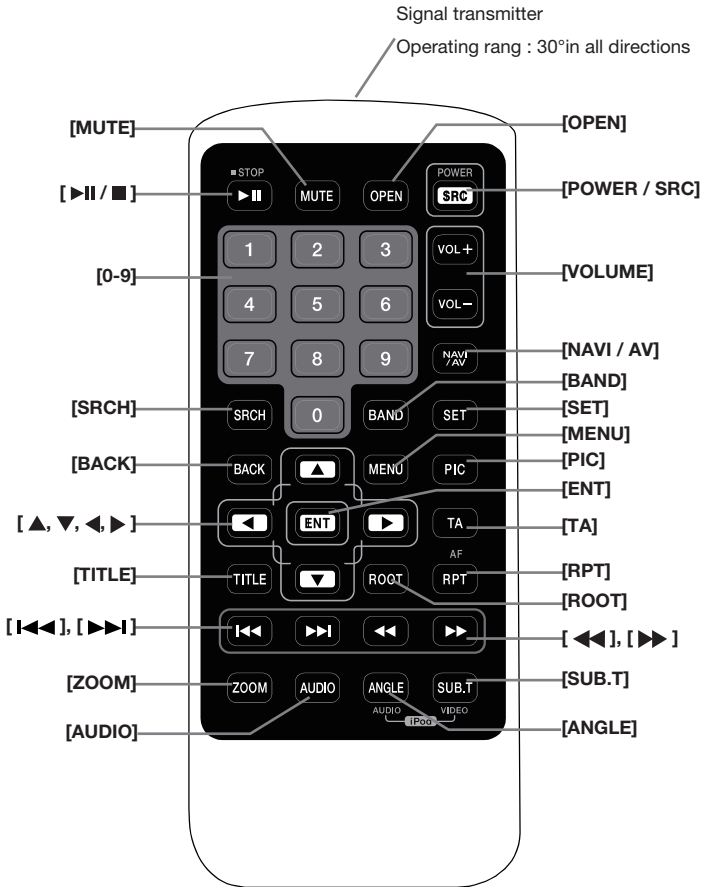

Replacing the batteries

1. Press the retention tab and pull out the battery tray and remove the old battery.
2. Insert the new CR2025 battery and slide the battery tray back in the remote control the same direction that you removed it.

Please ensure the tray is inserted in the correct direction.

Note:

Using batteries improperly can cause them to explode. Take note of the following points:

- When replacing batteries, replace both batteries with new ones.
- Do not short-circuit, disassemble or heat batteries.
- Do not dispose of batteries into fire or flames.
- Dispose of spent batteries properly.

⚠ WARNING

Lithium (CR) battery contain
Perchlorate
Dispose of discharged batteries properly.

Functions of Remote Control Buttons

You can use the remote control unit to control the NX501A.

Note:

- The wireless remote control operation may not be optimal in direct sunlight.

[▶||/■] Button

- Press this button to play or pause video and audio media.
- Press this button more than 1 second to stop video and audio media.

[MUTE] Button

- Mute or Unmute the speaker.
- The symbol  on upper right area of the screen indicates that speaker is muted.

[POWER/SRC] Button

- Press this button to move the focus to next available source item on main menu.
- Press this button to power on when the unit is power off.
- Press this button more than 1 second to power off when the unit is power on.

[0 - 9] Buttons

- Use in the Key Pad screen to select the radio channels.
- Use to select the track in the track list screen.
- Press to enter DVD video chapters/titles in the Key Pad screen.

[VOLUME] Buttons

- Increase and decrease volume.

[NAVI/AV] Button

- Press this button to switch between current source and current position on navigation map.

[SRCH] Button

- Press this button to open chapter or title search window while playing DVD.

[BAND] Button

- Switch to next band alternately.

[SET] Button

- Press this button to open the Audio setting menu in any mode.

[BACK] Button

- Press this button to quit main menu if current screen is main menu.

[▲], [▼], [◀], [▶] Buttons

- Press this button for cursor movement in main menu or Setting mode.
- From the main menu, you can select your desired source or change your settings.

[MENU] Button

- Press this button to enter the MAIN MENU or return current resource.

[PIC] Button

- Press this button to change your monitor brightness.

[ENT] Button

- Press to fix the entered data in the Key Pad screen or enter the item the cursor is on.

[TA] Button

- Press to TA On/Off.

[TITLE] Button

- Press to go to the title menu on the DVD.

[ROOT] Button

- Press to go to the root menu on the DVD.

[RPT] Button

- Press to perform chapter repeat / title repeat / repeat off while playing DVD mode.
- Press to perform track repeat/repeat off while playing CD.
- Press to perform repeat track /repeat folder/ repeat off while playing MP3/WMA, or video files on disc.
- Press to perform repeat track /repeat folder/ repeat off while playing MP3/WMA, or video files in USB memory.
- Press for AF On/Off.

[◀◀], [▶▶] Buttons

- Press to seek the next available higher or lower station in Tuner mode.
- Press to select the next higher or lower chapter number in DVD video mode.
- Press to select the next higher or lower track in DVD Audio, USB Video, USB Audio mode.
- Press for movement of background source in Navigation mode.

Functions of Remote Control Buttons

[◀◀], [▶▶] Buttons

- Press to manually select the next higher or lower station in Tuner modes.
- Press to perform fast-forward or fast-backward searching. Press again to change the speed to 2x, 4x, 8x or 16x.
- Press for movement of background source in Navigation mode.

[ZOOM] Button

- Press to turn on and zoom in while playing DVD. You can zoom in up to 3x. (No all DVD disc supports this function).

[AUDIO] Button

- Press to switch the AUDIO channel of the disc while playing DVD.

[SUB-T] Button

- Press to switch next available subtitle while playing DVD.
- Press to display Video menu in iPod mode.

[ANGLE] Button

- Press to switch the different ANGLE while playing DVD. (No all DVD disc supports this function)
- Press to display Audio menu in iPod mode.

[OPEN] Button

- This button is not effective.

6. MAIN MENU OPERATIONS

Front Zone Source

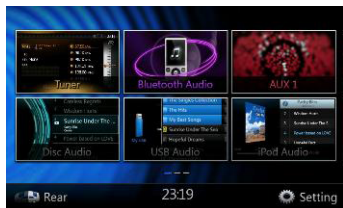

[Tuner]-Press the button to display the Tuner mode.

[Disc Audio]-Press the button to display the Disc Audio mode.

[Bluetooth Audio]-Press the button to display the Bluetooth Audio mode.

[USB Audio]-Press the button to display the USB Audio mode.

[AUX 1] - Press the button to display the AUX 1 mode.

[iPod Audio]-Press the button to display the iPod Audio mode.



[DVB-T]-This button is not effective. (No specification).

[Disc Video]-Press the button to display the Disc Video mode.

[Camera]-Press the button to display the Camera mode.

[USB Video]-Press the button to display the USB Video mode.

[AUX 2]-Press the button to display the AUX 2 mode.

[iPod Video]-Press the button to display the iPod Video mode.



[Navigation]-Press the button to display the Navigation mode.

[Telephone]-Press the button to display the Telephone mode.

[Rear Button]-Press the button to display the rear menu.

[Setting Button]-Press the button to display the setting menu.

Rear Zone Source



[Rear Disc Video]-Press the button to display the Rear Disc Audio mode.

[Rear AUX 1]-Press the button to display the Rear AUX 1 mode

[Rear iPod Video]-Press the button to display the Rear iPod Video mode.

[Rear AUX 2]-Press the button to display the rear AUX 2 mode.

[2-Zone Off]-Press the button to closed the rear activity.

[Front Button]-Press the button to display the front main menu.

[Setting Button]-Press the button to display the setting menu.

Scrolling the menu

Press screen and scrolling to right or left it will switch to next or previous page of mainmenu.

Moving the menu position

1. Press any quadrate icon on mainmenu more than 2 seconds, the icon will float on mainmenu.
2. Scrolling the floating icon to any position you want.

7. DVD SYSTEM

DVD video is a high-quality digital video source that provides crisp and clear images. One 12 cm disc contains either one film or four hours of music.

DVD Video Features

This unit provides the following functions in addition to the high image quality and sound quality of DVD video.

Note:

- The functions described in this section, for example, the recorded language, subtitles, angles, etc. differ depending on the DVD video disc.
- Refer to the instructions provided with the DVD video.
- Some disc functions may operate differently from described in this manual.

Multi-sound function

DVD video can store up to 8 languages for one film; select the language of your preference.

- The languages stored on the disc are indicated by the icon shown below.



Multi-angle function

A DVD video that is filmed from multiple angles allows you to select the angle of choice.

- The number of recorded angles are indicated by the icon shown below.

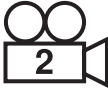

Subpicture (subtitles) function

A DVD video can record subtitles for up to 32 languages and you can select the language of the subtitles you wish to see.

- The number of recorded subtitle languages are indicated by the icon shown below.



Multi-story function

When a DVD video contains more than one story for a film, you can select the story you wish to enjoy. The operation procedures vary with the disc; observe the instructions for selecting a story provided during playback.

Menu screens

Menu can be called up during DVD video playback to perform menu setting.

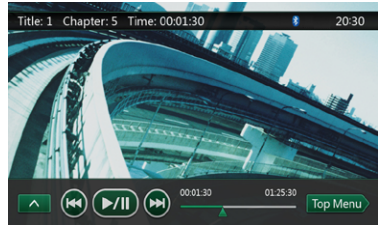

- Example showing menu display



Discs

Playable discs

This DVD video player can play the following discs.

Playable discs		
 DVD video discs	 Audio CDs	 CD TEXT

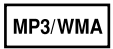
Playable media files
 MP3/WMA

About CD Extra discs

A CD Extra disc is a disc in which a total of two sessions have been recorded. The first session is Audio session and the second session is Data session. Your personally-created CDs with more than second data sessions recorded cannot be played on this DVD video player.

Note:

- When you play a CD Extra disc, only the first session will be recognized.

About playing a CD-R/CD-RW disc (MP3, WMA)

This player can play CD-R/CD-RW discs previously recorded in music CD format (MP3, WMA).

About playing a DVD-R/RW or DVD+R/RW disc

This player cannot play DVD-R/RW and DVD+R/ RW discs previously recorded in video CD format.

However, MP3/WMA files recorded on DVD-R/ RW and DVD+R/RW discs can be played.

Discs that cannot be played back

This DVD video player cannot play back DVD-Audio, DVD-RAM, Photo CDs, etc.

Note:

- *It may also not be possible to play back CDs recorded on a CD-R unit and CD-RW unit. (Cause: disc characteristics, cracks, dust/dirt, dust/dirt on player's lens, etc.)*
- *If a CD-R or CD-RW disc that has not been finalized is played, it will take a long time to start playing. Also, it may not be possible to play depending on its recording conditions.*
- *You cannot play SuperAudio CDs Playback of the CD player is not supported even if it is a hybrid disc.*

About MP3/WMA playback

This unit can play back CD-R/CD-RW, DVD-R/ RW and DVD+R/RW discs on which MP3/WMA music data have been recorded.

For a detailed information, see the section entitled "Listening to MP3/WMA".

Note on region numbers

The DVD video system assigns a region number to DVD video players and DVD discs by sales area.

DVD video players sold in the Australia can play back DVD discs with the region number "**ALL**", "**4**" or any combination of numbers that also incorporate a "**4**".

The DVD video region number is marked on the disc jacket as shown below.

**About the registered marks, etc.**

- This product incorporates copyright protection technology that is protected by U.S. patents and other intellectual property rights. Use of this copyright protection technology must be authorized by Rovi Corporation, and is intended for home and other limited viewing uses only unless otherwise authorized by Rovi Corporation. Reverse engineering or disassembly is prohibited.
- Manufactured under license from Dolby Laboratories. "Dolby", "Pro Logic" and the double-D symbol are trademarks of Dolby Laboratories.
- "Made for iPod," and "Made for iPhone" mean that an electronic accessory has been designed to connect specifically to iPod, or iPhone, respectively, and has been certified by the developer to meet Apple performance standards.

Apple is not responsible for the operation of this device or its compliance with safety and regulatory standards. Please note that the use of this accessory with iPod or iPhone may affect wireless performance. iPhone and iPod are trademarks of Apple Inc., registered in the U.S. and other countries.

- The Bluetooth® word mark and logos are owned by the Bluetooth® SIG, Inc. and any use of such marks by Clarion Co., Ltd. is under license. Other trademarks and trade names are those of their respective owners.

8. DVD VIDEO PLAYER OPERATIONS

Change DVD System Settings

Note: If the set up operation is performed in the middle of DVD video play, the disc will restart from the beginning.

Selecting DVD Set Up Menu

1. Press the **[Setting]** button on the Main Menu to access the Video set up menu.
2. Press **[Video]** button. The video menu is displayed.

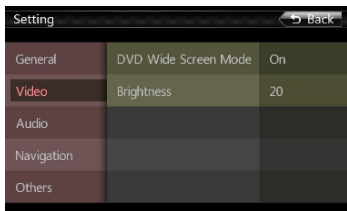

Setting up the Screen Size

Press the **[DVD Wide Screen Mode]** button to turn on or turn off the DVD wide screen mode. The factory default setting is "On".

Note: Not all DVD disc supports this function.

DVD Wide Screen Mode On



DVD Wide Screen Mode Off

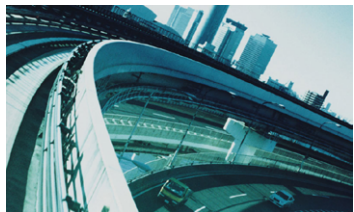

Setting up the password for parental level control

The factory default pass code is "0000".

1. In Main Menu press **[Setting]** button. Press **[Others]** button on the display. Touch the **[Set Password]** ---- and a numerical key pad will appear. Input the old password, and touch the **[OK]** key, or input "4356" to reset password.



Input a new password, and touch the **[OK]** key. Input the same new password again, and touch the **[OK]** key.

Note: When a disc with view restrictions is inserted, you will be prompted to input this password. The disc will not be viewable until the correct password is entered.

Set rating for parental level control

1. Select Others screen while in Setting mode. Press **[Parental Control]** button. Press the desired rating for level control. Use this table to set the parental level.

Kid Safe	Kid Safe
G	General Audiences
PG	Parental Guidance Suggested
PG-13	Parents Strongly Cautioned
PG-R	Parental Guidance Restricted
R	Restricted
NC-17	No One 17 And Under Admitted
Adult	Only Adult

- The contents that the parental level restricts vary with the country code.

Note: The rating can be selected only under the password unlocked status, and the limits can be set only under the password locked status.

Watching to a disc

1. To load a disc:

Insert the disc into the center of the insertion slot the label side facing up.

⚠ CAUTION

For your safety, the driver should not insert or eject a disc, opening the operation panel while driving.

Note:

- Never insert foreign objects into the disc insertion slot.
 - If the disc is not inserted easily, there may be another disc in the mechanism or the unit may require service.
 - 8cm (single play) discs cannot be used.
2. Disc starts playing automatically.

⚠ WARNING

Some videos may be recorded at higher than desired volume levels. Increase the volume gradually from the minimal setting after the video has started.

Ejecting a disc

1. To eject a disc press eject [▲] button. The play mode then switches to the Tuner mode.

If the disc is left in the ejected position for 15 seconds, the disc is automatically reloaded. In this case, the play mode will remain in the Tuner mode.

Note: If you force a disc into before auto reloading, it may damage a disc.

Showing DVD Player mode screen

After disc is loaded, the play mode is automatically engaged.

Touch any place of the screen to display DVD Video menu touch the screen again to return the playback screen. The display will return to the playback screen, if you do not touch the screen for 10 seconds.

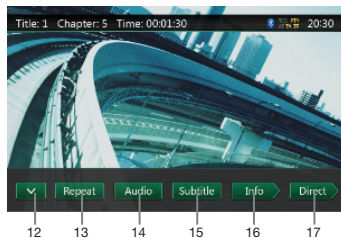

- 1 - Next page Buttons
- 2 - Previous Track /Fast Backward Button
- 3 - Play/Pause Button
- 4 - Next Track/Fast Forward Button
- 5 - Elapsed playing time
- 6 - Seek bar
- 7 - Total time
- 8 - Top Menu Button
- 9 - System time
- 10 - Bluetooth status
- 11 - DVD playback info
- 12 - Previous page Button
- 13 - Repeat switching Button
- 14 - Audio Channel switching Button
- 15 - Subtitle switching Button
- 16 - INFO Button
- 17 - Direct chapter or title searching Button

Operate the DVD Player menu

You can select the button items displayed in the DVD menu by directly touching it.

Play/Pause Playback

1. Touch [▶/⏸] button to pause during playback.
2. Touch [▶/⏸] button again to resume playback.

Skip (Search) a Chapter

1. Press [◀] or [▶] button during playback. Chapters are skipped down or up from current locations, as many times as the button is pressed, and playback starts.

Skip use seek bar

Press the triangle [▲] on seek bar and drag it to any position where you want to start playback.

Fast Forward/Fast Backward

1. Press **[FF]** or **[FB]** button and hold 2 seconds to start fast backward or fast forward during playback. The playback speed starts at 2x, then will increase to 4x, 8x, and 16x. Release the button will continue playing with normal speed.
2. **[◀▶]** or **[▶▶]** button on remote control can also be used to start fast backward or fast forward during playback.

Note:

- No audio is reproduced during fast forward and fast backward operation.
- The fast forward and fast backward speed may differ depending on the disc.

Stop Playback

1. Press the **[■]** button on remote control more than 1 second. Playback is stopped.
2. To resume playback, press the **[▶/||]** button. Playback resumes from start of the disc.

Search with a Chapter/Title Number

You can locate the beginning of a scene using the chapter numbers or title numbers recorded on the DVD Video disc.

1. Showing the DVD Video menu, touch **[Direct]** button. The Key Pad screen appears with the chapter/Title number input mode.

Touching **[Chapter]** button turns the Key Pad to the chapter number input mode.

Touching **[Title]** button turns the Key Pad to the title number input mode.

• Title

A large segment to divide the data area of the disc.

• Chapter

A small segment to divide the data area of the disc.

2. Input the number of the title/chapter that you want to play with the **[0]** to **[9]** key.
3. Touch the **[OK]** button.

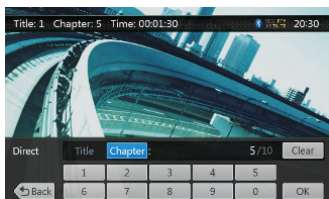

Playback starts from the scene of the input title number or chapter number.

Note:

If the input title/chapter number does not exist or searching with a title/chapter number is not allowed, the screen image will not change.

4. Touch **[Back]** button to close the key pad.

Repeat Playback

This operation plays back chapters recorded on the DVD-Video repeatedly.

1. Showing the DVD Video menu, touch **[Repeat]** button.
2. Touch **[Repeat]** button once for Chapter Repeat, again for Title Repeat.
3. Press **[Repeat]** button again to turn off the repeat playback.

Using the Title Menu

On DVD discs containing two or more titles, you can select from the title menu for playback.



1. Showing the DVD Video menu, touch **[Top Menu]** button during playback.

The title menu screen appears.

* Depending on the disc, the title menu may not be called.

2. Touch the title menu screen.

3. Select the items in the title menu screen by **[Left]**, **[Up]**, **[Down]**, **[Right]** directional buttons.

* Depending on the disc, items may not be selected with the directional buttons.

4. Touch **[OK]** button to fix on the selected item.
5. Touch **[Back]** button.

Switching Audio

On discs in which two or more audios or audio languages have been recorded, you can switch among the audio languages during playback.

1. Showing the DVD Video menu, touch  button during playback.

- Each time you touch the button, you can switch among audio languages.
 - It may take time to switch among audios.
- Depending on the disc, up to 8 kinds of audios may be recorded. For details, see the mark of the disc:  Indicates that 8 audios have been recorded).

When the power is turned on and when the disc is changed to a new one, the language set as the factory default is selected. If that language has not been recorded on disc the language is specified on the disc.

Depending on the disc, switching may be completely impossible or impossible on some scenes.

Switching Subtitles

On DVD discs in with two or more subtitle languages have been recorded, you can switch among the subtitle languages during playback.

1. Showing the DVD Video menu, touch  button to select a subtitle during playback. Each time you touch the key, you can switch among subtitles.

- It may take time to switch among subtitles.
- Depending on the disc, up to 32 kinds of subtitles may be recorded. For details, see the mark of the disc:  Indicates that 8 kinds of subtitles have been recorded).

Depending on the disc, switching may be completely impossible or impossible on some scenes.

2. To turn off subtitles, repeat touching  button until subtitles are turned off.

Switching angles

On DVD discs in with video images have been recorded in two or more angles, you can switch among the angles during playback.

1. Touch [Angle] key on the remote control during playback. Each time you touch the key, you can switch among angles.
- It may take time to switch among angles.
- Depending on the disc, up to 9 angles may be recorded. For details, see the mark of the disc:  Indicates multi-angle).
- Depending on the disc, angles may switch smoothly or switch with a momentary still image.
- Depending on the disc, switching may be completely impossible or impossible on some scenes.
- Depending on the disc, scenes recorded in two or more angles may be played back.

Displaying the playback status

Touch  button on DVD Player mode screen, Playback status is displayed on screen.

Play disc video files

This system can play video files (MP4, etc) stored on disc.

Showing video files Player mode screen

1. After disc with video files is loaded, touch [DVD Video] button on MAIN MENU to show video files player mode screen.
2. Touch the screen of the playing video file to display Video files player menu touch the screen again to return the playback screen. The display will return to the playback screen, if you do not touch the screen for 10 seconds.

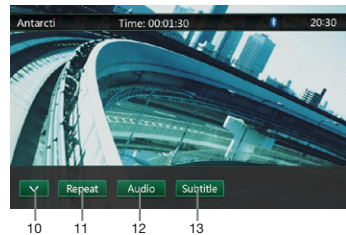
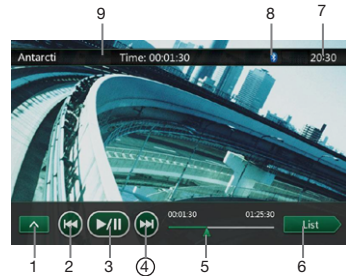



- 1 - Next page Button
- 2 - Previous Track /Fast Backward Button
- 3 - Play/Pause Button
- 4 - Next Track/Fast Forward Button
- 5 - Elapsed playing time /Seek bar
- 6 - List Mode Button
- 7 - System time
- 8 - Bluetooth status
- 9 - Playback info
- 10 - Previous Row Buttons
- 11 - Repeat Button
- 12 - Audio Button
- 13 - Subtitle Button



Operate the Video files Player menu

You can select the button items displayed in the Video files player menu by directly touching it.

Play/Pause Playback

1. Touch  button to pause during playback.
2. Touch  button again to resume playback.





Switch to Previous/next file

1. Press  or  button during playback to play previous /next file

Skip using seek bar

Press the triangle on seek bar and drag it to any position where you want to start playback.

Fast Forward /Fast Backward



1. Press  or  button and hold 2 seconds to start fast backward or fast forward during playback. The playback speed starts at 2x, then will increase to 4x, 8x, and 16x. Release the button will continue playback with normal speed.
2.  or  button on remote control can also be used to start fast backward or fast forward during playback.

Note:

No audio is reproduced during fast forward and fast backward operation.

The fast forward and fast backward speed may differ depending on the disc.



Stop Playback

1. Press the  button on remote control more than 1 second. Playback is stopped.
2. To resume playback, press the  button. Playback resumes from start of the folder which playing track is in.

Repeat Playback

This operation plays back video files recorded on the disc repeatedly.

The repeat set as the factory default is Repeat Folder.

1. Showing the video files player menu, touch  button.
2. Touch  button once for Repeat off, again for Repeat Track.
3. Press  button again for Repeat Folder.

Switching Audio

Some video files will have two or more audio channels; you can switch among the audio channels during playback.

1. Touch  button during playback.
 - Each time you touch the button, you can switch among audio languages.
 - It may take time to switch among audios.
- Depending on the disc, switching may be impossible.

Switching Subtitles

Some video files will have two or more subtitles have been recorded; you can switch among these subtitles during playback.

1. Touch the  button to select a subtitle during playback.
 - Each time you touch the key, you can switch among subtitles.
 - It may take time to switch among subtitles.
- Depending on the disc, switching may be impossible.

Video files list

Showing the Video files player menu; touch the  button to display video files list screen.

Video files list operations is almost same as Disc Audio player mode. Please refer to DVD Audio Player Operations.

9. DVD AUDIO PLAYER OPERATIONS

Listening to a disc/Ejecting a disc

Please refer to Disc Video Player Operations -watching to a disc and Ejecting a disc.

Showing CD Player mode screen

1. After disc is loaded, the play mode is automatically engaged.
2. If disc have been loaded you can touch **[Disc Audio]** button on main menu to display CD player mode screen.

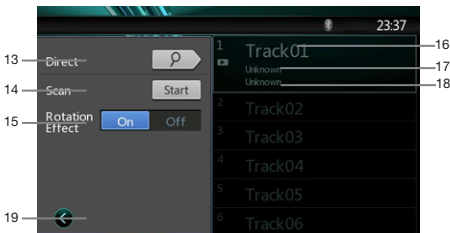
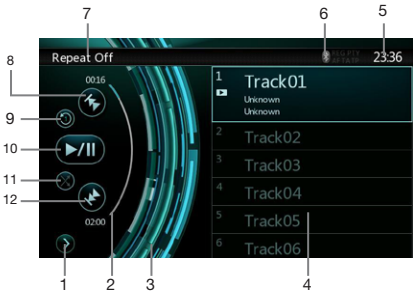

- 1 - Open option menu Button
- 2 - Elapsed playing time indicator
- 3 - Rotation effect
- 4 - Audio files or CD tracks.
- 5 - System time
- 6 - Bluetooth status
- 7 - Play back status
- 8 - Previous Track /Fast Backward Button
- 9 - Repeat Button
- 10 - Play/Pause Button

- 11 - Shuffle Button
- 12 - Next Track/Fast Forward Button
- 13 - Direct Searching Button
- 14 - Scan Start/Stop Button
- 15 - Rotation Effect On/Off Button
- 16 - Song Title
- 17 - Artist Information
- 18 - Album Information
- 19 - Close option menu Button

Operate the CD Player menu

You can select the button items displayed in the CD player menu by directly touching it in list.

Play/Pause Playback

1. Touch **[▶/||]** button to pause during playback.
2. Touch **[▶/||]** button again to resume playback.

Switch to Previous/next file or track

Press **[◀]** or **[▶]** button during playback to play previous /next file.

- Pressing **[▶]** button starts playback from the beginning of the next track.
- Pressing **[◀]** button starts playback from the beginning of the current track. When this button is pressed again within 5 seconds, playback starts from the beginning of previous track.

Fast Forward /Fast Backward

1. Press **[⏮]** or **[⏭]** button and hold more than 2 seconds to start fast backward or fast forward during playback. The playback speed starts at 2x, then will increase to 4x, 8x, and 16x. Release the button will continue playback with normal speed.
2. **[◀◀]** or **[▶▶]** button on remote control can also be used to start fast backward or fast forward during playback.

Note:

- No audio is reproduced during fast forward and fast backward operation.
- The fast forward and fast backward speed may differ depending on the disc.

Stop Playback

1. Press the **[■]** button on remote control more than 1 second. Playback is stopped.
2. To resume playback, press the **[▶/||]** button. Playback resumes from start of disc.

Repeat Playback

The repeat set as the factory default is Repeat Track.

Touch the  button once for Repeat off, again for Repeat Track.

Shuffle Playback

1. Touch  button to shuffle the tracks during playback.
2. Touch this button again to turn off the feature.

Selecting a track on the Track List Screen

This function allows you to select tracks from a displayed list.



1. Touch the track title on the display list. The selected track will start playing.
2. When the desired track is not displayed, press and flick the track list up or down.
3. Touch the desired track title key. The corresponding track is started playback.

Scanning the Tracks



1. Touch  button to show **[Scan Start]** button.
 2. Touch **[Scan Start]** button during playback.
 - It will play from next track, and each track will display for 10 seconds.
 - The **[Scan Start]** button will switch to **[Scan Stop]** button.
 3. Touch **[Scan Stop]** button.
 - It will continue playback from current track.
 - **[Scan Stop]** button will switch to **[Scan Start]** button.
- * The function will scan all tracks orderly in current folder once. After Scan stopped playback will continue.

Searching with the Track Number

This operation allows searching using the track numbers recorded on the CDs.

1. Touch  Button to show  button.
2. Touch  button. The numerical keypad will appear on the screen.
3. Input the track number that you want to play back with **[0]** to **[9]** key.



Playback starts from the track of the input track number.

- If the input track number does not exist or searching with track number is not allowed, the screen image will not change.
- Touch the  button will close the numerical keypad.
- Touch  Button will close the option window and display playback screen.

Rotation Effect On/Off

This operation allows turn on/turn off rotation effect.

The factory default is On.

1. Touch  Button to show **[Rotation effect]** button
2. Press button  will turn on the Rotation effect.
3. Press button  will turn off the Rotation effect.

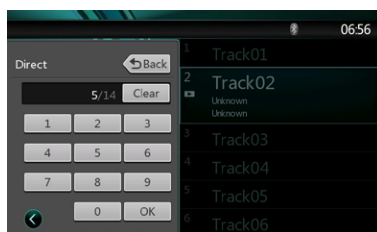

Listening To MP3/WMA

This unit is an ID3 Tag compatible model.

This unit supports the ID3 TAGs of the Version 2.4, 2.3, 1.1 and 1.0.

In displaying, this unit gives priority to the Version 2.3 and 2.4 TAGs.

What is MP3/WMA?

MP3 is an audio compression method and classified into audio layer 3 of MPEG standards.

WMA is an audio compression method developed by Microsoft Corporation.

These audio compression methods have penetrated into PC users and become a standard format.

These features compress the original audio data to about 10 percent of its initial size with a high sound quality. This means that about 10 music CDs can be recorded on a CD-R disc or CD-RW disc to allow a long listening time without having to change CDs.

Note: Some CDs recorded on CD-R/RW mode may not be usable.

Displaying MP3/WMA TAG titles

Tag information such as title, artist and album title can be displayed for MP3/WMA file containing Tag information.

Precautions when creating MP3 disc

- File extensions
 1. Always add a file extension “.MP3” or “.mp3” to an MP3 file, and “.WMA” or “.wma” to a WMA file by using single byte letters. If you add a file extension other than specified or forget to add these file extension, the file cannot be played. In addition, if you use upper case and lower case letters (capital and small letters) mixed for file extensions, normal play may not be possible.

2. Files other than MP3/WMA data cannot be played.

Playing files with a format not supported will be skipped, and the scan, random and repeat playback mode may be canceled.

• File and Disc Not Supported

Files and discs with following extensions are not supported: *.AAC, *.DLF, *.M3U, *.PLS, *.MP3 PRO files, files with DRM, open session discs.

• Logical format (File system)

1. When writing an MP3/WMA file on a disc, please select "ISO9660 level 1 or level 2 (without including expansion format)" as the writing software format. Normal playback may not be possible if the disc is recorded on another format.

2. The folder name and file name can be displayed as the title during MP3/WMA play but the title must be within 31 single byte alphabetical letters and numerals for the folder name and file name (including an extension). Entering more letters or numerals than specified may cause an incorrect display.

• Entering File and Folder Names

Names using the code list characters are the only file names and folder names that can be entered and displayed. Using any other character will cause the file and folder names to be displayed incorrectly.

• Electronic Shock Protection

10 seconds for CD-DA (CDA)

45 seconds for MP3 recorded at 44.1 kHz, 128 kbps

90 seconds for WMA recorded at 44.1 kHz, 128 kbps

• Folder structure

1. A disc with a folder having more than 8 hierarchical levels will conflict with the ISO9660 and playback will be impossible.

• Number of files or folders

1. The maximum allowable number of folders is 255 (including root directory); the maximum allowable number of files is 1500 (max. 255 per folder). This represents the maximum number of tracks that can be played back.

2. Tracks are played in the order that they were recorded onto a disc. (Tracks might not always be played in the order displayed on the PC).

- Some noise may occur depending on the type of encoder software used while recording.
- In case of a track recorded at VBR (variable bit rate), the display for the play time of the track may be slightly different from the actual play time. Also, the recommended value of VBR ranges from 32 kbps to 320 kbps.
- After disc selection, the play mode is automatically engaged.

Playing MP3 folders

When selected for play, files and folders (Folder Search, File Search or Folder Select) are accessed in the order in which they were written to the media. As a result, the order in which they are expected to be played may not match the order in which they are actually played.

You may be able to set the order in which MP3/WMA files are to be played by assigning file names beginning with play sequence numbers such as "01" to "99".

For example, a medium with the following folder/ file hierarchy is subject to Folder Search, File Search or Folder Select.

See the diagram below.

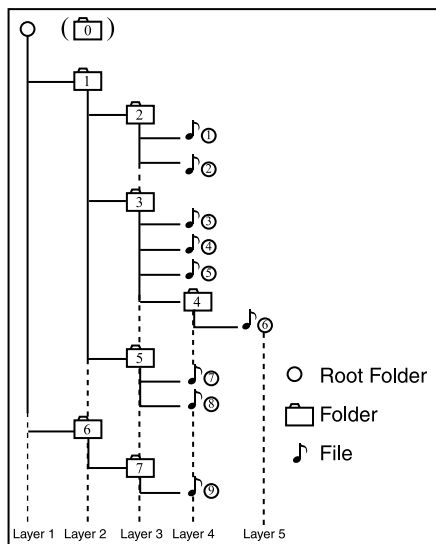

The player will only recognize three folder levels and does not display folders containing other folders. In the example above, the unit will display folders 2, 3, 5 and 7, but 1 and 6 since they do not contain others.

Playback MP3/WMA menu



1. Repeat Playback

While playing MP3/WMA touch  button can switch between Repeat Track Repeat Folder and Repeat Off.



2. Folder

Touch the folder title on the display list, the file list will display files and folders in selected folder.

3. Current Folder

- Showing title of current folder.
- The number on the folder symbol is the number of files and folders number in current folder.
- Touch the title of current folder, play list will show files and folders in upper folder.

Stop Playback

1. Press the  button on remote control more than 1 second. Playback is stopped.
2. To resume playback, press the  button. Playback resumes from start of the folder which playing track is in.

Other operations about playing MP3/WMA are almost same as CD Player mode.

10. USB AUDIO OPERATIONS

This system can play audio files (MP3/WMA) stored in an USB memory which is recognized as "USB Mass Storage Class device". You can use your USB memory as an audio device by simply copying desired audio files into it.

Note:

- This system will not operate or may operate improperly with some USB memory.
- Files protected with any DRM cannot be played.

Notes on using USB memories

General notes

- When no support files, the file list display nothing.

Notes on the MP3/WMA files

- This system can play the MP3/WMA files stored in the USB memory.
- Set the Sampling Frequency to:
 - For MP3 files:
 - MPEG1 Layer3: 32, 44.1, or 48 kHz
 - MPEG2 Layer3: 16, 22.05, or 24 kHz
 - For WMA files: 32, 44.1, or 48 kHz
- Set the Bit Rate to:
 - For MP3 files:
 - MPEG1 Layer3: 32 to 320 kbps (VBR)
 - MPEG2 Layer3: 16 to 160 kbps (VBR)
 - For WMA files: 64, 80, 96, 128, 160, or 192 kbps
- Add the following file extension using single byte characters:
 - For MP3 files: ".MP3" or ".mp3"
 - For WMA files: ".WMA" or ".wma"

Notes on the folder structure

- The folder hierarchy must be within 8 hierarchical levels. Otherwise, playback may be impossible.
- The maximum allowable number of folders is 65535(including root directory and folders with no MP3/WMA file).
- The maximum allowable number of files in a folder is 65535.
- You can store the MP3 files, WMA files together in a folder.
- The system may become slow if the files or folders exceed the limitation above.

Notes on the Tag titles

The limitations on the Tag titles are same as those in DVD Audio Player mode.

Select USB Audio mode

Connect your USB memory with MP3/WMA files to the USB connector. The system will automatically detect the connected device, and the **[USB Audio]** button on main menu will be enabled.

- When an USB memory is already connected

Touch **[USB Audio]** button to select the USB Audio mode.

The system changes to the USB Audio mode and starts playback from the previous position or from the beginning.

Note:

If you reconnect the same device that you disconnected last, the system will play back where it left off.

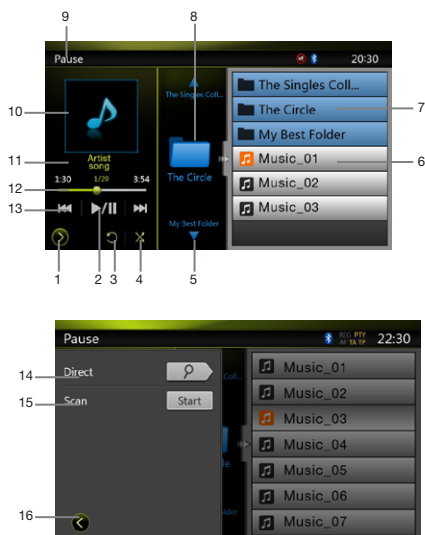



- 1 - Open option menu Button
- 2 - Play/Pause Button
- 3 - Repeat Button
- 4 - Shuffle Button
- 5 - Next Track/Fast Forward Button
- 6 - MP3/WMA files in list
- 7 - Folders in list
- 8 - Folders browse control
- 9 - Playback status info
- 10 - Album Art



- 11 - Current ID3 info area
- 12 - Elapsed playing time indicator/Seek bar
- 13 - Previous Track /Fast Backward Button
- 14 - Direct Button
- 15 - Scan Button
- 16 - Close option menu Button



Playing MP3/WMA files in USB memory

Play/Pause Playback





1. Touch  button to pause during playback.
2. Touch  button again to resume playback.

Switch to Previous/next file

Press  or  button during playback to play previous /next file.

- Pressing  button starts playback from the beginning of the next track.
- Pressing  button starts playback from the beginning of the current track; when this button is pressed again within about 5 seconds, playback starts from the beginning of previous track.



Fast Forward /Fast Backward

1. Press  or  button and hold more than 2 seconds to start fast backward or fast forward during playback. The playback speed starts at 2x, then will increase to 4x, 8x, and 16x .Release the button will continue playback with normal speed.
2. [ or ] button on remote control can also be used to start fast backward or fast forward during playback.

Note:

- No audio is reproduced during fast forward and fast backward operation.
- The fast forward and fast backward speed may differ depending on the audio files.

Stop Playback

1. Press the  button on remote control more than 1 second. Playback is stopped.
2. To resume playback, press the  button. Playback resumes from start of the folder which playing track is in.

Repeat Playback

The repeat set as the factory default is Repeat Folder. Touch the  button once for Repeat Track, again for Repeat Folder.

Note: The repeat in all USB files function is not available.

Shuffle Playback

1. Touch  button to shuffle the tracks in playing folder during playback.
2. Touch this button again to turn off the feature.

Album Art work

If current audio file contains album art image in ID3, the picture will be displayed in this area.

ID3 info area

This area display ID3 info of playing file: song title, artist information, album information, number of current file/total number in current folder, elapsed playing time/total time of current file.

Skip use seek bar

Press  on seek bar and drag it to any position where you want to start playback.

Select a folder on display list

Touch the folder title on the display list, the display list will display files and folders in selected folder.

Selecting a track on the display List

This function allows you to select tracks from a displayed list.

1. Touch the track title on the display list. The selected track will start playing.
2. When the desired track is not displayed, press and flick the track list up or down.
3. Touch the desired track title key. The corresponding track is started playback.

Folders browse control

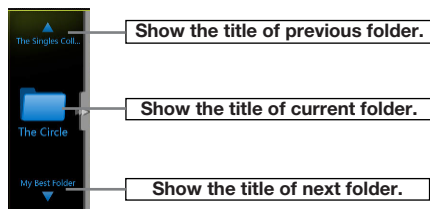



This area is same as the mouse touch panel of notebook computer. Flick up and down in this area will browse previous or next folder in current folder. Flick left or right will enter this folder or back to the father folder.

Scanning the Tracks



1. Touch  Button to show **[Scan Start]** button.
 2. Touch **[Scan Start]** button during playback.
 - It will play from next track, and each track will display for 10s.
 - The **[Scan Start]** button will switch to **[Scan Stop]** button.
 3. Touch **[Scan Stop]** button.
 - It will continue playback from current track.
 - **[Scan Stop]** button will switch to **[Scan Start]** button.
- * The function will scan all tracks orderly in current folder once .After Scan stopped playback will continue.

Searching with the Track Number

This operation allows searching using the track numbers in playing folder.

1. Touch  Button to show  button.
2. Touch  button .The numerical keypad will appear on the screen.
3. Input the track number that you want to play back with **[0]** to **[9]** key.

Playback starts from the track of the input track number.

- If the input track number does not exist or searching with a track number is not allowed, the screen image will not change.
- Touch  button will close the numerical keypad.
- Touch  Button will close the option window and display playback screen.



11. USB VIDEO OPERATIONS

This system can play USB video files (MP4, etc) stored in an USB memory which is recognized as "USB Mass Storage Class device". You can use your USB memory as an audio device by simply copying desired audio files into it.

Note:

- This system will not operate or may operate improperly with some USB memory.
- Files protected with any DRM cannot be played.

Notes on using USB memories

General notes

When no support files, the file list display nothing.

Notes on the folder structure

The limitations on the folder structure are same as those in USB Audio Player mode.

Notes on the Tag titles

The limitations in the Tag titles are same as those in DVD Audio Player mode.

Select USB Video mode

Connect your USB memory with video files to the USB connector. The system will automatically detect the connected device, and the [USB Video] button on main menu will be enabled.

• When an USB memory is already connected

Touch [USB Video] button on main menu to select the USB Video mode.

The system changes to the USB Video mode and starts playback from the previous position or from the beginning.

Note: If you reconnect the same device that you disconnected last, the system will play back where it left off.

Playing video files in USB memory

If the video is playing, touch the screen of the playing video to display Operation buttons.

- * The display will return to the playback screen, if you do not touch the screen for 10 seconds.



- 1 - Previous Track Button
- 2 - Play/Pause Button
- 3 - Next Track Button
- 4 - Elapsed playing time indicator/Seek bar
- 5 - Menu Button (Go to list menu mode)
- 6 - Repeat Button
- 7 - System time
- 8 - Bluetooth status
- 9 - Playback info

Play/Pause Playback

1. Touch [Play/Pause] button to Pause playback.
2. Touch [Play/Pause] button to resume playback.

Switch to Previous/next file

Press [Previous] or [Next] button during playback to play previous /next file.

- Pressing [Next] button starts playback from the beginning of the next track.
- Pressing [Previous] button starts playback from the beginning of the current track; when this button is pressed again within about 5 seconds, playback starts from the beginning of previous track.

Repeat Playback

- * The repeat set as the factory default is Repeat Folder.

Touch the [Repeat] button once for Repeat Track, again for Repeat Folder.

Note: The repeat in all USB files function is not available.

Skip use seek bar

Press the [Seek] on seek bar and drag it to any position where you want to start playback.

Switch to USB Video Menu

Press [Menu] button playback will be paused, and the screen will switch to USB Video Menu.

USB Video Menu Operations

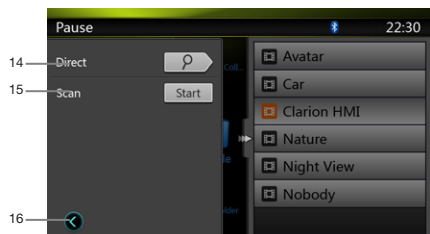
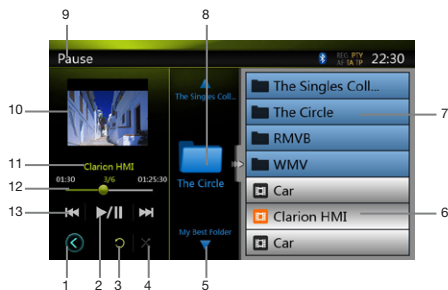

- 1 - Open option menu button
- 2 - Play/Pause Button
- 3 - Repeat Button
- 4 - Shuffle Button
- 5 - Next Track/Fast Forward Button
- 6 - Video files in list
- 7 - Folders in list
- 8 - Folders area
- 9 - Playback status info
- 10 - Album Art
- 11 - Current file info area
- 12 - Elapsed playing time indicator/Seek bar
- 13 - Previous Track /Fast Backward Button
- 14 - Direct Button
- 15 - Scan Button
- 16 - Close option menu button

Play/Pause Playback

On USB Video menu screen, playback status is pause. Touch button to resume playback. The screen will go to video screen automatically.

Switch to Previous/next file

Press or button during playback to play previous /next file.

- Pressing button starts playback from the beginning of the next track.
- Pressing button starts playback from the beginning of the current track; when this button is pressed again within about 5 seconds, playback starts from the beginning of previous track.

Stop Playback

1. Press the button on remote control more than 1 second. Playback is stopped.
2. To resume playback, press the button. Playback resumes from the first valid media file of the folder.

Repeat Playback

* The repeat set as the factory default is Repeat Folder.

Touch the button once for Repeat Track, again for Repeat Folder.

Shuffle Playback

1. Touch button to shuffle the tracks in playing folder during playback.
2. Touch this button again to turn off the feature.

Current file info area

This area displays info of current video file: file name, number of current file/total number in current folder, Elapsed playing time/total time of current file.

Skip use seek bar

Press on seek bar and drag it to any position where you want to start playback.

Select a folder on display list

This operation is same as this in USB Audio mode.

Selecting a track on the display List

This operation is same as this in USB Audio mode.

Folders area

This operation is same as this in USB Audio mode.

Scanning the Tracks

This operation is same as this in USB Audio mode.

Searching with the Track Number

This operation is same as this in USB Audio mode.

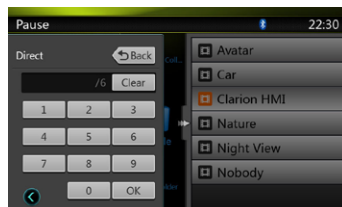

12. iPod/iPhone OPERATIONS

iPod/iPhone can be connected by the special connector cable (CCA-748) separately sold.

Note:

- This system will not operate or may operate improperly with unsupported versions.
- For detailed information on the playable iPod/iPhone models, see our home page: www.clarion.com

Notes on using Apple iPod/iPhone

- Do not connect an iPod/iPhone to this unit with a headphone connected to the iPod/ iPhone.
- After the iPod/iPhone has been connected to this unit, the buttons of iPod buttons are disabled for operation in the Music mode. In the Video mode, do not operate the buttons of iPod.
- When in the iPod mode, a special iPod/iPhone control screen is displayed different from the main screens for other modes.
- When in the iPod mode, the screen image input from the AUX terminal is output to the rear monitor.
- When no data is present, the title display will remain blank.
- The iPod/iPhone is used with the equalizer function turned OFF.
- Set the language setting of iPod/iPhone to English before connecting your iPod/iPhone. Some characters of the other languages may not be displayed correctly in this system.

Precautions on battery consumption:

If the iPod/iPhone is connected to this unit when the internal battery of iPod/iPhone has run down, this function may not operate correctly. You must connect the iPod/iPhone after charging the battery if it has run down.

Selecting the iPod Audio mode

Connect your iPod/iPhone to the USB connector via CCA-748 cable. The system will automatically detect the connected device and the iPod Audio button will be enabled for operation on the Main Menu screen.

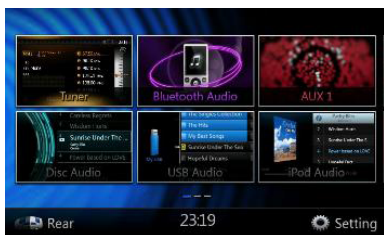

The playback starts after a while, from where the iPod/iPhone has been paused.

- When iPod/iPhone is already connected Touch the **[iPod Audio]** button on the Main Menu screen. The system changes to the iPod mode, and starts playback from the previous position. Press **[MENU]** button on Operational Panel to return to the Main Menu.

Controlling the iPod/iPhone

iPod audio mode screen

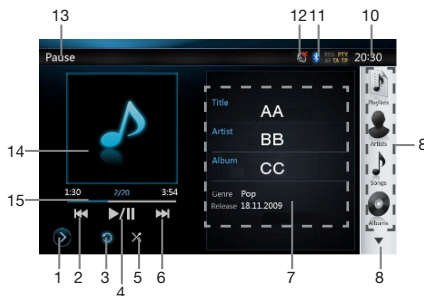

1. Settings Button
Displays the Options screen. You can specify play modes and other settings from this screen.
2. Previous Track Button
3. Repeat Button
Use to repeat the selected track.
Press once to start a single track repeat. Press again to activate a repeat all. To turn repeat off, press same button again. Repeat symbols are displayed in the info window in the upper left area of the screen.
: All repeat.
: 1-Track repeat.
: Repeat off.
4. Play/Pause Button
Use to control playback and pause.
(1). Touch the key during playback. Playback pauses.
(2). To resume playback touch the key again.
5. Shuffle Button
Use to switch the shuffle mode on or off. When enabled, this function performs playback of tracks in random order, regardless of the order in which they are recorded.
: Shuffle Off.
: Song Shuffle.

6. Next Track Button

7. ID3 Information

Touch the area of the ID3 Information to display the current play list.

Touch the icon can return to ID3 information display.

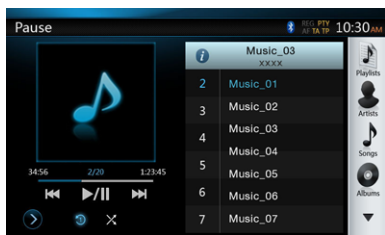

8. Next Page [] / Previous Page [] Button

9. Category List

Select different category songs to play. The category is same as the iPod/iPhone.

10. System Time

11. Bluetooth Status

12. MUTE Status

13. Playback Status

14. Art Work

15. Progress bar

iPod audio settings mode screen

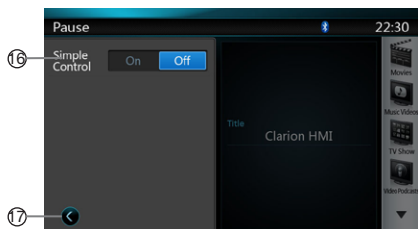

16. Simple Control:

If the Simple Control is set to . The screen will become to Simple Control Mode. It can also display the video of iPod/iPhone regardless it is iPod Audio or iPod Video mode. But only "Previous Track", "Play/Pause" and "Next Track" can be operated. (Refer to 17)

17. Close the Settings Page

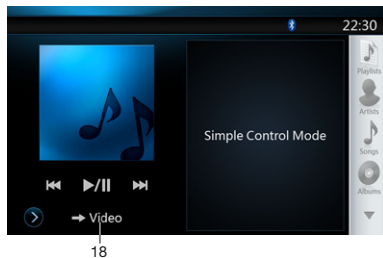

18. Display video of iPod/iPhone.

Follow operation steps to display video of iPod/iPhone in Simple Control Mode.

- Connect the iPod to USB connector via CCA-748 cable.
- Select iPod Audio mode.
- Press the button on iPod audio mode screen to display Settings page.
- Set the Simple Control to "On".
- Press button.
- Set iPod Video settings TV Out to "ON" in iPod.
- Now play video from iPod
- Video of iPod will display on the screen.
- iPhone and iPod Touch are not supported with video output in Simple Mode.



19. Previous files

20. Play or Pause video

21. Next files

22. Progress bar

The "Progress bar" is not available on this screen.

23. Menu:

Press the Menu button can display the Simple Control Mode.

24. Repeat

The "Repeat" Button can't operate on this screen.

Skipping a track (Simple Control Mode)

Press the **[⏮]** or **[⏭]** button during playback. Tracks are skipped, as many times as the button is pressed, and playback starts.

- Pressing the **[⏭]** button starts playback from the beginning of the next track.
- Pressing the **[⏮]** button starts playback from the beginning of the current track.

When this button is pressed again within about 2 seconds, playback starts from the beginning of the previous track.

Note: In Simple Control Mode, the best way is to control the iPod just on iPod.

Selecting a list item from a list screen

- (1). Touch the list screen and flick up or down to scroll the list.
- (2). Touch a desired list item on the screen to display the corresponding list of tracks.
- (3). Touch the desired track name on the list to play it.

iPod audio List mode screen

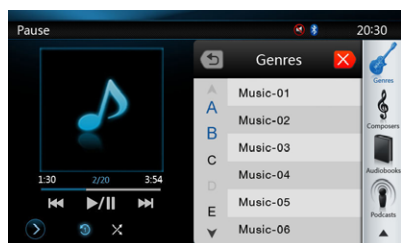
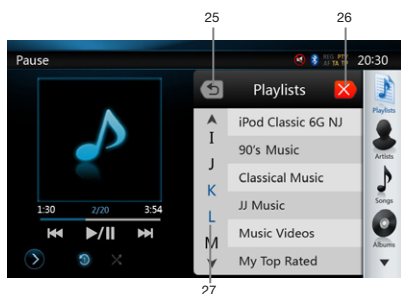

25. Return to the Previous Level Folder

[⏪] If the list is in root, press the button can close the list.

26. **[✕]** Closed the List

27. Search with the first alphabet in current list.

Selecting the iPod Video mode

Connect your iPod/iPhone to the USB connector via CCA-748 cable. The system will automatically detect the connected device and the iPod Video button will be enabled for operation on the Main Menu screen.



- When an iPod/iPhone is already connected

Touch the **[iPod Video]** button on the Main Menu screen. The system changes to the iPod Video mode, and starts playback from the previous position.

Press **[MENU]** button on Operational Panel to return to the Main Menu.

- Viewing video data in the iPod/iPhone (only for the iPod/iPhone with video features)

When you connect an iPod/iPhone with video features by using the optional CCA-748 cable, you can enjoy the video data and slide show data stored in the iPod/iPhone and show them on the display of this unit (and the rear monitor if connected).

- iPod Video ID3 mode screen



Press **[⏪]** button to display iPod Video play mode screen.

iPod Video List mode screen

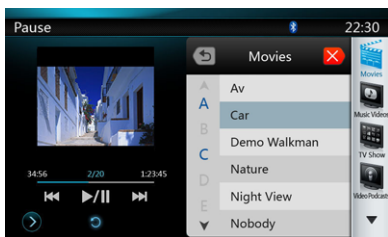

- iPod Video Settings mode screen.

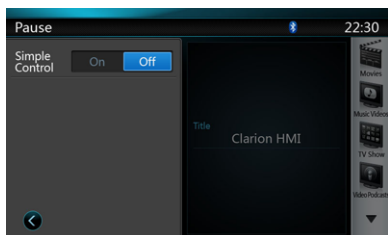

- iPod Video Simple Control Mode Screen

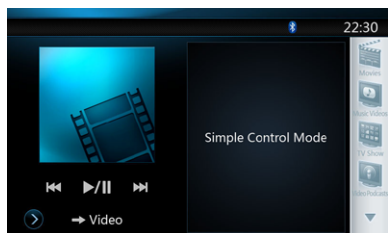

- iPod Video play mode screen.



1. iPod Video Title.
2. Elapsed playing time.
3. **Menu** Menu:

Press the Menu button can display the iPod Video mode screen.

4. **Repeat** Repeat Button:

Use to repeat the selected track.

Press once to start a single track repeat. Press again to activate a repeat all. To turn repeat off, press same button again. Repeat symbols are displayed in the info window in the upper left area of the screen.

In iPod Video mode screen, there are three repeat icons :

- Repeat All.
- Repeat 1 Track.
- Repeat off.

Note:

The operation keys in iPod video mode are as same as iPod Audio mode. Please refer to the iPod Audio Mode operation key.

Note:

Video playback is not available on all iPod/ iPhone devices. Please contact your Clarion dealer for details. An optional connection cable or accessory may be required for this feature.

Note:

- "AUDIO ONLY" is displayed when the automobile is moving.
- Image data may not be played back according to the status of the iPod/iPhone
- The volume setting of video data is relatively lower than audio data. Be sure to lower the volume setting before switching to the other mode.
- Do not select the categories with no track registered from the iPod menu screen. The iPod/iPhone may be frozen. If the iPod/iPhone is frozen, reset the iPod/iPhone by following the procedure described in the instruction manual of the iPod/iPhone.
- Audio may be played back slightly out of synchronization with video images.

13. Bluetooth AUDIO PLAYER OPERATIONS

Some Bluetooth cellular phones have audio features, and some portable audio players support the Bluetooth feature. These devices will be called as “Bluetooth audio players” in this manual. This system can play audio data stored in a Bluetooth audio player.

Note:

- This system will not operate or may operate improperly with some Bluetooth audio players.
- For detailed information on the playable Bluetooth audio players, see our home page: www.clarion.com

Selecting the Bluetooth Audio mode

1. Press **[MENU]** button on Operational Panel to return to the Main Menu.
2. Touch the **[Bluetooth Audio]** key to select the Bluetooth Audio mode.

The system changes to the Bluetooth mode. If the connection with a Bluetooth audio player has been already established, you may select the Music function.

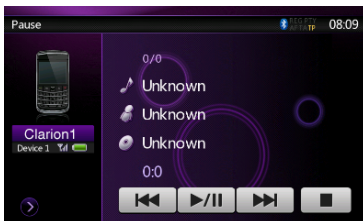

- When the connection with a Bluetooth audio player has been established, the  icon is displayed at the top of the screen.



Bluetooth audio player settings

Confirming Bluetooth Information and setting Pass Key

You can confirm various information concerning about the Bluetooth Interface features.

1. Touch the  key to display the information on the screen.
2. When you finish confirming the Bluetooth information, touch the  key to return to the previous screen.

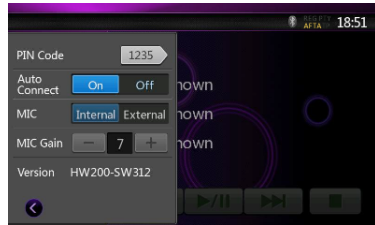

If you want to change the Pin Code setting of this unit, perform the following steps.

- The factory default setting is “1234”.
3. Touch the text box of the Pin Code item to display the Ten-Key Pad screen.
 4. Enter your desired 4-digit PIN number, and then touch the  key.

Note:

MIC Gain is disabled in Bluetooth Audio mode settings.

Registering your Bluetooth audio player (Pairing)

You can register up to 5 Bluetooth audio players.

1. Turn on the power of the Bluetooth audio player you wish to register.
2. Touch the Device key  to display the Device Select screen.

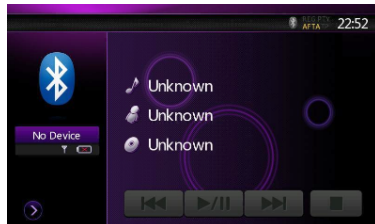

3. Touch the  key to display the Inquiring Device screen.



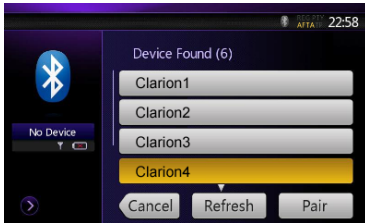

4. Touch your desired Device and press the **[Pair]** key to register for the Bluetooth audio player.
5. If entering the Pass Key code is prompted on your Bluetooth audio player, enter the Pass Key code set to this unit.
 - You can change the Pass key setting of this unit from the BT Info screen.
 - You also can add the favorite icon to the connected device. There are 10 favorite icons for selection.

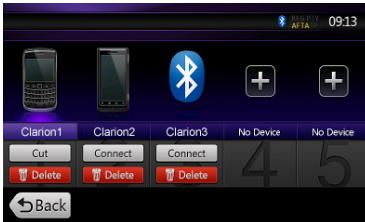

When the pairing operation completes, the registered Bluetooth audio player is set as the current device, after selecting the favorite icon, the display return to the device list screen. Press **[Back]** button, the display will return to the Bluetooth audio mode screen.

Note:

- You cannot register the same Bluetooth audio player which is already registered. If you wish to change the Device key registered, once delete the corresponding Bluetooth audio player from the previous Device key, and then register it again to your desired Device key.
- To delete the Bluetooth audio player registration
 1. Touch the **[Delete]** key to delete the device. A confirmation screen is displayed.
 2. Touch the **[OK]** key to confirm delete.

Selecting the Bluetooth audio player

To change the current Bluetooth audio player to the other device which is already registered, perform the following operation.

1. Touch the Device key to **[Bluetooth]** display the Device Select screen.
 2. Touch the currently connected device, then press the **[Cut]** key to disconnect the active device.
 3. Touch the desired Device key you wish to use. Press **[Connect]** key to select it as your active device. The corresponding cellular phone is set as current telephone.
 - If the power of the cellular phone is not turned on, turn it on.
 - The cellular phone may prompt to acknowledge the Bluetooth connection or ask to enter the Pass Key code of this unit.
- Perform these operations according to the message displayed.
4. Touch the **[Back]** key to return to the previous screen.

Controlling the Bluetooth audio player

Note:

- Occasionally, depending on the environment, playback sounds may be fragmented, or switch noises may be generated.

Playing a music

After the connection with a Bluetooth audio player is established, the play mode is automatically engaged.

- When playback is not started for some devices, touch the **[Play/Pause]** key manually.

Pausing playback

1. Touch the **[Play/Pause]** key during playback. Playback pauses.
2. To resume playback, touch the **[Play/Pause]** key. Playback resumes.

Skipping a track (searching)

3. Press the **[Previous]** or **[Next]** button during playback. Tracks are skipped, as many as the times the button is pressed, and playback starts.

Stopping playback

4. Press the **[Stop]** button during playback. Tracks are stopped, press the **[Play/Pause]** button to playback the first Track.

14. Bluetooth TELEPHONE OPERATIONS

When the connection with your Bluetooth cellular phone is established, the following functions are available on this unit:

- Listening to your telephone calls on the car speakers.
- Answering to an incoming call.
- Making a call using the Ten-Key pad screen.
- Making a call using the Phone Book data in the selected cellular phone.
- Making a call using the History data of the dialed/ received calls.

Note:

- Some cellular phones may not be able to transfer the Phone Book data to head unit.
- The Phone Book data transmission may take a long time. The operations of sending calls are disabled during the data transmission.
- You can talk with other party by using the internal microphone. When it is hard to hear for the other party in accordance with the communication condition or the used telephone, please use the optional microphone (RCB-199), and set the Microphone Select setting to "External". The sound will be improved, but noises may still be heard depending on the communication condition.

Select the BT Phone mode

1. Press **[MENU]** button on Operational Panel to return to the Main Menu.
2. Touch the **[Bluetooth Telephone]** key to select the Bluetooth Telephone mode.

The Telephone screen is displayed.

- When no Bluetooth Telephone connected, the icon  is displayed at the top of the screen.

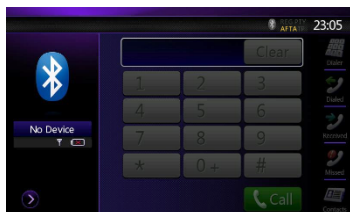

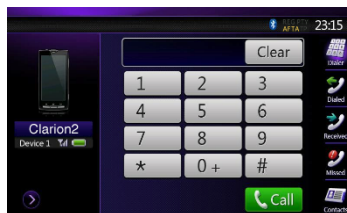

- When the connection with a Bluetooth Telephone has been established, the icon  and signal level indicator are displayed at the top of the screen.



Bluetooth Telephone settings

Confirming Bluetooth Information and setting Pass Key

You can confirm various information concerning the Bluetooth Interface features.

1. Touch the  key to display the information on the screen.
2. Perform setting for the desired item. See the following sections for detail.
3. When you finish confirming the Bluetooth information, touch the  key to return to the previous screen.

If you want to change the Pass Key setting of this unit, perform the following steps.

1. Touch the text box of the Pass Key item to display the Ten-Key Pad screen.
- The factory default setting is "1234".
2. Enter your desired 4-digit PIN number, and then touch the  key.

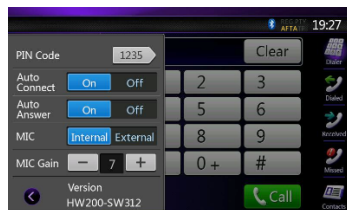

Setting Automatic Connection

The system automatically reconnects the cellular phone after the connection is lost or the system is restarted.

- The factory default setting is "OFF". Touch the **[On]** or **[Off]** key of the Automatic Connection item to set the function ON or OFF.

Setting Automatic Answer

If a call comes in, answer automatically after 5 seconds.

- The factory default setting is "OFF". Touch the **[On]** or **[Off]** key of the Automatic Answer item to set the function ON or OFF.

Selecting Microphone

You can select the microphone to be used.

- The factory default setting is "Internal". Touch the **[Internal]** or **[External]** key of the Microphone Select item to set the function.

Setting Microphone Gain

You can adjust the input level of the microphone in 16 levels.

- The factory default setting is "7".
- Touch the level indicator button of the Microphone Gain item to adjust the input level.

Note:

- The input level of the microphone can be affected by its surroundings. Adjust the level if the person on the other end of the telephone has a reception problem.

Register your cellular phone (Pairing)

You can register up to 5 cellular phones. The registering method is as same as "Registering your Bluetooth audio player".

- Turn on the power of the cellular phone you wish to register.
- Touch the Device key **[Bluetooth]** to display the Device Select screen.

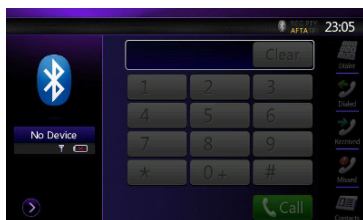

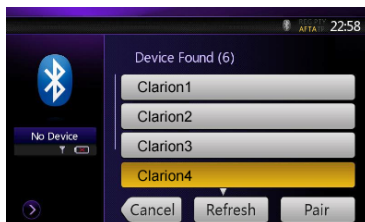
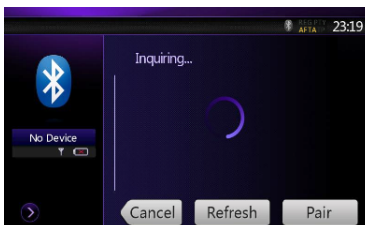
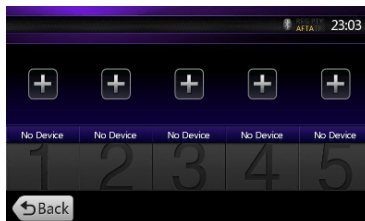

- Touch the **[+]** key to display the Inquiring Device screen.







- Touch your desired Cellular key to select the key for the cellular phone to be registered. And press the **[Pair]** key to register for the Bluetooth audio player.
 - You cannot select the Cellular key of which another cellular phone is already registered. Select a blank Cellular key.
 - If entering the Pass Key code is prompted on your cellular phone, enter the Pass Key code set in this unit.
 - You can change the Pass key setting of this unit from the BT Info screen under the Telephone Settings screen.
 - You can also add the favorite icon to the connected device. There are 10 favorite icons for selecting.
- When the pairing operation completes, the registered cellular phone is set as the current telephone, and the display returns to the Telephone screen.

Note:

- You cannot register the same cellular phone which is already registered. If you wish to change the Cellular key registered, once delete the corresponding cellular phone from the current Cellular key, and then register it again to your desired Cellular key.
- To delete the cellular phone registration
 1. Touch the  key to delete the device. A confirmation screen is displayed.
 2. Touch the  key to confirm delete.

Select the cellular phone

To change the current cellular phone to the other device which is already registered, perform the following operation.

1. Touch the  key to display the Device Select screen.
 2. Touch the currently connected device, then press  key to disconnect the active device.
 3. Touch the desired Device key you wish to use. Press  key to select it as your active device. The corresponding cellular phone is set as the current telephone.
- If the power of the cellular phone is not turned on, turn it on.
 - The cellular phone may prompt to acknowledge the Bluetooth connection or to enter the Pass Key code of this unit. Perform these operations according to the message displayed.
4. Touch the  key to return to the previous screen.

Obtaining the Phone Book data

Sending the Phone Book data from the cellular phone enables you to make a call using the Phone Book function from this unit.

1. Perform the Object Push transfer operation of the Phone Book data on the current cellular phone.
- For details of the operation, see the operation manual of the cellular phone.

Note:

- Some cellular phones may not be able to transfer the Phone Book data.
- Some cellular phones cannot transfer the Phone Book data when the hands-free mode is set or it is also registered in the Bluetooth mode. In those cases, disable these functions from the cellular phone before performing the Object Push transfer.
- Some cellular phones may transfer Phone Book data automatically.



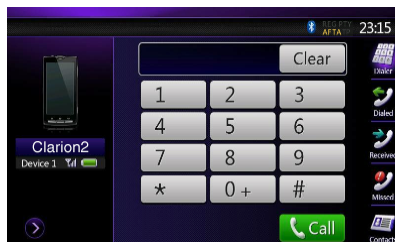

Telephone operations**Making a call using the Ten-Key pad**

1. Touch the  key to display the Ten-Key pad screen.
2. Enter the telephone number by using the Ten-Key pad displayed on the screen.

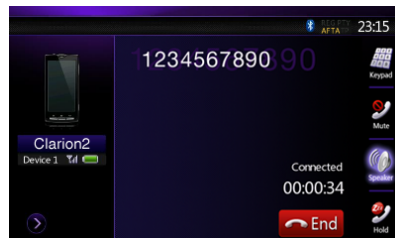

3. Touch the  (Send) key to call the entered number.
- The following Telephone Interrupt screen is displayed during phone call.



- Touch the  key to talk by using the cellular phone and canceling the hands-free function (Private Mode). To return to the hands-free mode, touch the  key again.
 - Touch the  key to mute the microphone. Now you can hear the other side, but the other side cannot hear your side.
 - Touch the  key to hold the current phone call, now you can answer to the other incoming call. Touch again to talk with previous call.
4. When the call is finished, touch  key to hang up.

Note:



- Depending on some special cellular phone, the Telephone Interrupt screen may be closed and the connection with this system may be disconnected when entering the Private mode.

Making a call using the Phone Book

You can use the Phone Book data obtained from the cellular phone to make a call from this unit.



Note:

- Before using this function, the Phone Book data must be sent from the cellular phone.
- Only the Phone Book items with at least one telephone number registered in the captured Phone Book data are displayed on the Phone Book screen.

1. Touch the  key to display the Phone Book screen.
2. Touch the desired Name key you wish to dial.
- Flick the list up and down to scroll the list.
3. Touch the  key to call the specified number. The Telephone Interrupt screen is displayed, and calling starts.
- When the call is finished, touch the  key to hang up.

Making a call using the History

The system will memorize the Dialed/Received calls record data in the memory. You can confirm it and use it to make a call from this unit.



1. Touch the  key. The History List screen is displayed.
- The items are sorted by Dialed, Missed and Received calls.
- Flick the list up and down to scroll the list.
2. Touch the desired History item key you wish to dial.
3. Touch the  key to call the specified number. The Telephone Interrupt screen is displayed, and calling starts.
- When the call is finished, touch the  key to hang up.

Answering to an incoming call

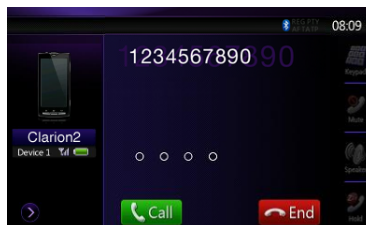
When a call comes in, the following Telephone Interrupt screen appears.



You can answer to the incoming call on this system by the following operation.

1. Touch the  key to answer the call.
2. When the call is finished, touch the  key to hang up.

15. RADIO OPERATIONS

Listening to the Radio

1. Touch the **[Tuner]** button on the Main menu display. The tuner mode screen is displayed.
2. Press the **[FM1/2/3/AM]** button or touch the **[Band]** key on remote control to select the radio band. Each time the button is pressed, the radio reception band changes in the following order: FM1->FM2->FM3->AM ->FM1...



1. Preset Scan Button
2. Direct Button
3. Preset List Button
4. Frequencies Display
5. Tune Up
6. Tune Down
7. Band Display
8. LOC/DX Display
9. Bluetooth Display
10. RDS Station Display
11. System Time

Seek Tuning

1. Press the **[FM1/2/3/AM]** button to select the radio band (FM or AM).
 2. Touch the **[Direct]** key, and then flick the BIG Frequency up and down to search for next available station.
- When flick the frequency up, the station is searched in the direction of higher frequency.
 - When flick the frequency down, the station is searched in the direction of lower frequency.

Step Tuning

1. Press the **[FM1/2/3/AM]** button to select the radio band (FM or AM).
2. Touch the **[▲]** or **[▼]** key in frequency panel to tune up or down by one step.

Recalling a preset station

1. Press the **[FM1/2/3/AM]** button to select the desired band (FM or AM) on the tuner.
2. Touch the **[Preset]** key, Press the preset station (1 to 6) on preset list.
3. Press the **[>]** key, then press the **[Start]** button to auto search and store the stations.

Manual memory

1. Touch the desired Band key to select the band you wish to store.
2. Tune to a station you want to store using the seek tuning, step tuning, or preset tuning.
3. Touch and hold the desired Preset key you want to store for about 3 seconds.

Auto Store

The Auto Store is a function for storing up to 6 stations that are automatically searched in sequentially. If the number of receivable stations cannot reach to 6, the previous stored station remains.

1. Touch the **[FM1/2/3/AM]** key to select the desired band. (FM or AM)
2. Press the **[>]** key, and then press the **[Start]** key to start the Auto Store.

A beep sounds and the stations with good reception are stored automatically to the preset list.

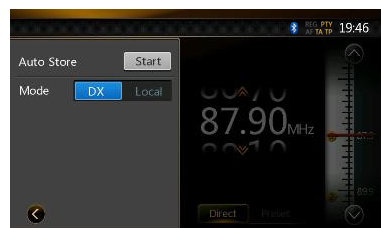

Preset Scan

The Preset Scan receives the stations stored in the preset memory in order. This function is useful when searching for the desired station in memory.

1. Touch the **[FM1/2/3/AM]** key to select the desired band. (FM or AM)
2. Touch the **[Preset Scan]** key to start the Preset Scan.

The unit starts scanning each station for 10 seconds sequentially. But the station stored is not a valid station; the scanning time is only 2 seconds.

3. When the desired station is tuned in, touch the **[Preset Scan]** key again to stay in that station.

LOC/DX Setting

The DX / LOC setting changes the tuner sensitivity in order to separate closely spaced stations. This feature is useful in areas that have many radio stations in close proximity.

1. Touch the **[Local]** key to switch to LOCAL tuner sensitivity.
2. Touch the **[DX]** key to switch to DX tuner sensitivity.

16. RDS OPERATIONS

This unit has a built in RDS decoder system that supports broadcast stations transmitting RDS data. This system can display the name of the broadcast station being received (PS), and can automatically switch to the broadcast station with the best reception as you move long distances (AF switching). Also, if a traffic announcement or program type information is broadcast from an RDS station, no matter what mode you are in, this broadcast is received. Additionally, if EON information is received, this information enables automatic renewal of other preset stations on the same network and interruption of traffic announcement and/or chosen program type from other stations (TP). This function is not available in some areas.

“**AF**”: Alternative Frequency

“**PS**”: Program Service Name

“**PTY**”: Program Type

“**TP**”: Traffic Program

- The RDS interrupt does not function during AM (MW/LW) radio reception.

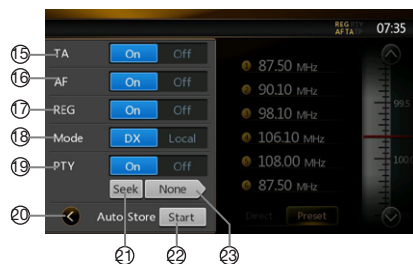



1. Band Display
2. LOC/DX Display
3. Frequencies Display
4. RDS Station Display
5. Time Display
6. PS Name Display
7. Program Type Display
8. Radio text Display
9. Setting Button
10. Preset Scan Button
11. Direct Button
12. Preset List Button
13. Tune Down
14. Tune Up
15. TA Setting
16. AF Setting
17. REG Setting
18. LOC/DX Mode Setting
19. PTY Setting
20. Return Button
21. PTY Seek
22. Auto Store
23. Program Type Display

AF (Alternative Frequency) function

The AF function switches to a different frequency on the same network in order to maintain optimum reception.

Switching ON/OFF the AF function

1. Touch the  key.
 2. Touch the  or  key of the AF item to turn the function on or off.
- When the AF function is ON, "AF" will be displayed at the top of the screen.
 - If the reception of the current broadcast station deteriorates durably, "AF" indication will blink, and this unit searches for the same program on another frequency.

REG (Regional Program) function

When the REG function is ON, the optimum regional station can be received. When this function is OFF, if the regional station area is switched as you drive, a regional station for that region is received.

Note:

- This function is disabled when a national station such as BBC R2 is being received.
- The REG function ON/OFF setting is enabled only when the AF function is ON.

Switching ON/OFF the REG function

1. Touch the  key.
2. Touch the  or  key of the REG item to turn the function on or off.

Manually tuning a regional station in the same network.

Note:



- This function can be used when a regional broadcast of the same network is received.
- This function is enabled only when the AF function is ON and the REG function is OFF.

1. Touch the [FM1/2/3/AM] key to select the band.
2. Touch your desired Preset key to call out a regional station.
3. Each time you touch the same Preset key; this unit switches from a local station to the other on the same network.

TA (Traffic Announcement) function

When a traffic announcement broadcast starts during the TA standby mode, the traffic announcement broadcast is received as top priority regardless of the function mode, so you can listen to it. The Traffic Program (TP) automatic tuning is also available.

Setting TA standby mode

1. Touch the  key.
2. Touch the  key of the TA item to set the TA standby mode.

"TA" will be displayed at the top of the screen, and the system will automatically search for a TP station (TP SEEK). When an RDS broadcast station with traffic announcement program is received, "TP" will be displayed at the top of the screen.



Note:

- If no TP station is received, this system continues the search operation. Performing the above procedure again makes the "TA" go off, and stops TP station searching.

Canceling a Traffic Announcement broadcast

Touch the [Cancel] key while a Traffic Announcement broadcast is being received. The Traffic Announcement broadcast reception is canceled, and the system goes into the TA standby mode.

Canceling TA standby mode





1. When "TA" is displayed on the screen, touch the  key.
 2. Touch the  key of the TA item.
- "TA" on the screen goes off, and the TA standby mode is canceled.

PTY (Program Type) function

This function enables you to listen to a broadcast of the specified program type when the broadcast starts, even if the system operates in a mode other than the Tuner mode.



- Some countries do not yet have PTY broadcast.
- In the TA standby mode, a TP station has priority over a PTY broadcast station.

Selecting PTY

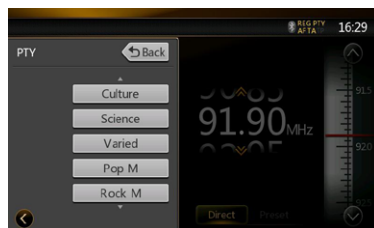

1. Touch the  key.
2. Touch the  key of the PTY item to enter the PTY standby mode.
3. Touch the  key (program type display) to display the PTY Select screen.
4. Touch your desired PTY Preset key to select the program type.
5. Touch the  key to return to the previous screen.



Canceling PTY standby mode

1. Touch the  key.
 2. Touch the  key of the PTY item.
- "PTY" goes off, and the PTY standby mode is canceled.

PTY seek

1. Touch the  key.
2. Touch the  key (program type display) to display the PTY Select screen.
3. Touch your desired PTY Preset key to select the program type.
4. Touch a Seek key, the system seeks a PTY broadcast moving up the frequencies.
 - If no station with the selected PTY broadcast can be received, the unit returns to the previous mode.
 - The 32 types of PTY listed below can be selected.

PTY item	
ENGLISH	Contents
None	None
News	News
Affairs	Current Affairs
Info	Information
Sports	Sport
Educate	Education
Drama	Drama
Culture	Culture
Science	Science
Varied	Varied
Pop M	Pop Music
Rock M	Rock Music
Easy M	Easy Listening Music
Light M	Light Classical Music
Classics	Serious Classical Music
Other M	Other Music
Weather	Weather
Finance	Finance
Children	Children's Programs
Social	Social Affairs
Religion	Religion
Phone In	Phone In
Travel	Travel
Leisure	Leisure
Jazz	Jazz Music
Country	Country Music
Nation M	National Music
Oldies	Oldies Music
Folk M	Folk Music
Document	Documentary
Test	Test
Alarm	Alarm

Emergency broadcast

If an emergency broadcast is received, all the function mode operations are stopped. "Alarm" appears on the screen and the emergency broadcast can be heard.

Volume setting of TA and emergency broadcast (Alarm)

The volume for TA, Alarm and PTY interrupts can be set during TA or Alarm.

- The factory default setting is "15".
1. Use the **[VOL +]** and **[VOL -]** buttons to set the volume to the desired level (00 to 40) during a TA or Alarm.
 - When the TA or Alarm ends, the volume returns to the level before the interrupt.

17. AUX 1 / AUX 2 OPERATIONS

External peripheral devices, including a game console, camcorder, iPod/iPhone, etc. can be connected to the AUX 1 or AUX 2 connector on the front or back of this unit using the AV media cables.

Switching to AUX IN / AV IN mode

- Press **[AUX 1]** or **[AUX 2]** button on Main Menu to select desired mode (when unit is connected). If the external device connected to AUX 1 or AUX 2 input have audio signal, the unit will broadcast audio of external device.
- Press **[Menu]** button on Operational Panel to return to the Main Menu.

You cannot directly control external devices connected to AUX 1 or AUX 2 input.

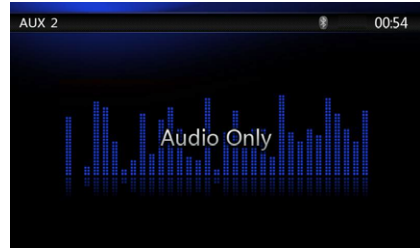

18. CAMERA OPERATIONS

Switching to Camera mode

Press **[Camera]** button on Main Menu to select desired mode.

The LCD will display the external camera video. The screen will display “No Video Signal” menu, if a valid camera is not connect to this head unit.

Press Menu button on Operational Panel to return to the Main Menu.

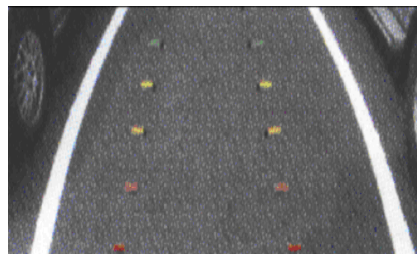
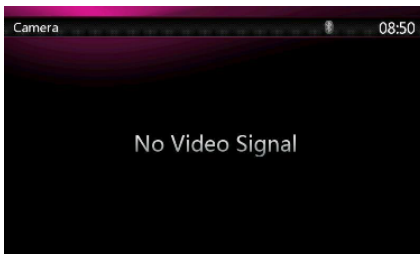

Note:

If the reverse cable is connected correctly to the car, the center unit to switch to camera mode automatically when the car is in reverses.

19. REAR SOURCE OPERATIONS

If rear monitors are installed in the rear seat and connected to the rear zone AV output, passengers in the back seats can watch the DVD/iPod Video/AUX1/AUX2 video separately from front source.



1. Press the button to access the rear source menu.
2. Press the button again to back to front source menu.

Multi-Zone Operation

Independent sources can be played simultaneously on the unit. For example, a FM/AM console can be playback on the front screen while DVD video is available to rear passengers. But now you can't select DVD video in front.

DVD Video in Rear



1. : Next Row Buttons
Press the button can display the hidden button.
2. : Previous chapter.
3. : Play or Pause video.
4. : Next chapter.
5. Elapsed playing time indicator.
6. : Top Menu Button

7. : Front/Rear switching button
If the screen displays Rear Source, press to switch to Front Source.
If the screen displays Front Source, Press to switch to Rear Source.



8. : Repeat switching Button
Use to repeat the Title or Chapter.
Press once to start Chapter repeat. Press again to activate Title repeat. To turn repeat off, press same button again. Repeat symbols are displayed in the info window in the upper left area of the screen.
9. : Audio Channel switching Button
10. : Subtitle switching Button
11. : INFO Button
12. : Direct chapter or title searching Button
DVD Video Rear Source Control Info mode.

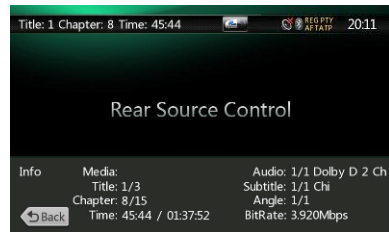

- Press button to return.

DVD Video Rear Source Control Direct mode.



Note: More detail please refer to DVD Video Front source.

AUX 1 in Rear

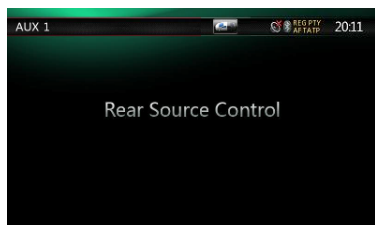

AUX 2 in Rear

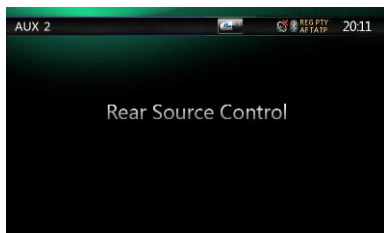

iPod Video in Rear

iPod Video Rear Source Control Play Mode

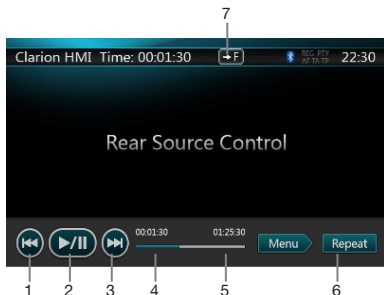

1. [Previous]: Previous file.
2. [Play/Pause]: Play or Pause video.
3. [Next]: Next file.
4. Elapsed playing time indicator.
5. [Menu]: Menu:

Press the Menu button can display the iPod Video Rear Source mode screen.

6. [Repeat]: Repeat Button(Same as iPod function of front source)

7. [Front]/[Rear]: Front/Rear button

If the screen displays Rear Source, press [Front] to switch to Front Source.

If the screen displays Front Source, Press [Rear] to switch to Rear Source.

iPod Video Rear Source ID3 Mode



Note:

If the source is selected as the front, the source in rear can't be selected.

If the source is selected as the rear, the source in front can't be selected.

Press the Front Button [Front] to access the front main menu but the rear source will keep running.

Remote Control in Rear

Remote Control is always available for the front source, however, it is available for the rear source if the screen displays Rear Source Control of DVD Video or iPod Video.

20. SETTING OPERATIONS

Press **Setting** button on the Main menu screen.
The Setting menu screen will be displayed.

General Setup Menu

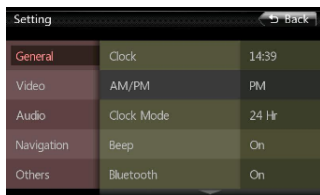

Clock: Set system clock.

AM/PM: Set AM or PM when current time mode is 12HR mode.

Clock Mode: Set the time display mode.

Beep: Turn on or turn off the beep confirmation sound.

Bluetooth: Set the Bluetooth ON or OFF.

Wallpaper: Choose the desired wallpaper.

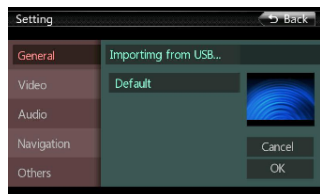
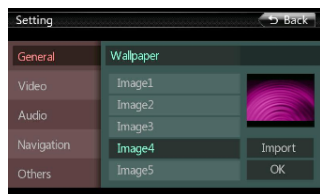

Auxin Input SW: Auxin input switch, including Low, Mid, High.

Dimmer: There are three options, Day, Night and Auto.

Tel Speaker: There are two options, Left and Right. For example, if current setting is Left, when BT phone is coming in, only left speaker can hear the phone.

Anti-Theft: Set the Anti-Theft code. (See next page)

Version: Display the software version information.

Video Setup Menu

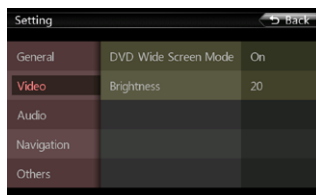

This menu includes: DVD Wide Screen Mode; Brightness.

DVD Wide Screen Mode: Set the DVD wide screen mode on or off.

Brightness: Set brightness value from 0 to 20.

Audio Setup Menu



This menu includes: Balance, Fader, Select EQ, Sub Woofer Ctrl, Sub Woofer Phase, High Pass Filter, low Pass Filter, Amp Cancel and Magna Bass EX.

Balance: Choose the desired volume for left and right speaker.

Fader: Choose the desired volume for front and rear speaker.

Select EQ: Choose the desired mode: Bass Boost, Impact, Excite, Custom and OFF.

Sub Woofer Ctrl: Choose the desired sub woofer gain from 0 to 14.

Sub Woofer Phase: Choose the sub woofer phase normal or reverse.

High Pass Filter: Choose the high pass filter through/55Hz/85Hz/120Hz.

Low Pass Filter: Choose the low pass filter through/62Hz/95Hz/135Hz.

Amp Cancel: Choose the amplifier audio output on or off.

Magna Bass EX: Choose the loudness on or off.

Navigation Setup Menu



This menu includes: GPS Time, Navi Interrupt, and Voice Guidance

GPS Time: Set the system time to be synchronized with GPS local time or not.

Navi Interrupt: There are three choose: On/Popup/Off. "On": The navigation screen will cover to AV screen when reaching some key point. "Popup": When small turn info window will pop up in the top of the AV screen to indicate the key point. "Off": Turn off this function.

Voice Guidance: Enable or disable the navigation voice guidance.

Others Setup Menu

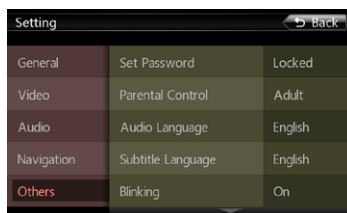

This menu include: Set Password; Parental control, Audio Language, Subtitle Language, Blinking, TS Calibrate, and Load Factory.

Set password: Set the password for DVD parental control.

Parental control: Set the rating of the age. It contains Kid Safe/G/PG/PG- 13/PG-R/R/NC- 17/Adult.

Audio Language: Set the Language for DVD Audio.

Subtitle Language: Set the Language for DVD subtitle.

Blinking: Choose the blinking ON or OFF.

TS Calibrate: The function of it is to select the Touch Screen Calibrate YES or NO.

Load Factory: The function is to select to load factory default or not.

Set the Anti-Theft code

1. If your unit is unlocked, hold the **[General]** button more then 2 seconds, then the Anti-Theft setting mode will display. Users can change anti-theft code. Click **[Yes]**, the numerical keypad is displayed. Enter the new password twice, then anti-theft code is set and your unit is secured.

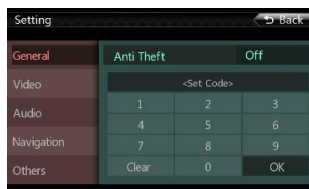

When the Anti-theft is "On", you need enter correct Anti-theft code to turn the unit on. If you enter wrong code three times, the unit is locked, and must be unlocked by the professionals.

- If your unit is secured, hold the [**General**] more than 2 seconds, then the Anti-Theft setting mode will display. The numerical keypad is displayed, enter the right code to unlock.

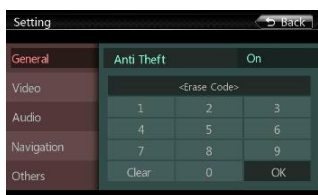

21. MONITOR OFF

Long Press Menu button on Operational Panel for 3 seconds, it will show "Monitor off.....Touch the screen to return" and then the head unit will turn off the TFT screen. Touch any place of the screen, the TFT screen will turn on again.

22. TROUBLESHOOTING

GENERAL

Problem	Cause	Measure
Power does not turn on. (No sound is produced.)	Fuse is blown.	Replace with a fuse of the same amperage. If the fuse blows again, consult your store of purchase.
	Incorrect wiring.	Consult your installation center.
Nothing happens when buttons are pressed. Display is not accurate.	The microprocessor has malfunctioned due to noise, etc.	Press the reset button with a thin rod. Note: When the Reset button is pressed, turn off the power. * When the Reset button is pressed, frequencies of radio stations, titles, etc. stored in memory are cleared.
The remote control unit does not work.	Direct rays of the sun fall on the light-receptive part of the remote control unit.	When direct rays of the sun fall on the light-receptive part of the remote control unit, it may not work.
	The battery of the remote control unit is dead or there is no battery in the remote control unit.	Check the battery of the remote control unit.

DVD PLAYER

Problem	Cause	Measure
Disc cannot be loaded.	A disc is already loaded.	Eject the disc before loading the new one.
	There is foreign matter already in the disc slot.	Remove the foreign matter, or consult a service station.
Sound skips or is noisy.	Disc is dirty.	Clean the disc with a soft cloth.
	Disc is heavily scratched or warped.	Replace with a disc in good condition.
Sound is bad directly after power is turned on.	Condensation may form on the internal lens when the car is parked in a humid place.	Let dry for about 1 hour with the power on.
Video images are not displayed.	The parking brake is not engaged.	Check that the parking brake is engaged.
Disc cannot play with the display "PARENTAL VIOLATION" shown.	Feature exceeds set parental level.	Release the view limitation or change the parental level. See the subsection "Setting up the parental level".

USB DEVICE

Problem	Cause	Measure
USB device cannot be inserted.	The USB device has been inserted with wrong direction.	Reversing the connection direction of the USB device, try it again.
	The USB connector is broken.	Replace with a new USB device.
USB device is not recognized.	The USB device is damaged.	Disconnect the USB device and reconnect. If the device is still not recognized, try replacing with a different USB device.
	Connectors are loose.	
No sound heard and no file display on file list	No MP3/WMA file is stored in the USB device.	Store these files properly in the USB device.
Sound skips or is noisy.	MP3/WMA files are not encoded properly.	Use MP3/WMA files encoded properly.
The video of iPod/iPhone image is disturbed	The TV Signal setting of the iPod/iPhone is not set correctly.	Set the TV Signal setting (NTSC/PAL) of the iPod/iPhone correctly.

Bluetooth

Problem	Cause	Measure
Cannot pair the Bluetooth enable device with the car audio system.	The device does not support the profiles required for the system.	Use another device to connect.
	The Bluetooth function of the device is not enabled.	Refer to the user manual of the device for how to enable the function.
The audio quality is poor after connection with a Bluetooth enabled device.	The microphone is not correctly positioned.	Use optional external microphone and adjust the position of it.
	The Bluetooth reception is poor.	Move the device closer to the car audio system or remove any obstacle between the device and the system.

TV/VTR (When connecting an optional TV tuner, etc.)

Problem	Cause	Measure
The image is not displayed.	The parking brake is not engaged.	Check that the parking brake is engaged.
The display is dark.	The brightness control is too low.	Adjust the brightness properly.
	The operating condition is not good.	The temperature inside the vehicle may be 0 or lower. Set to an appropriate temperature (25 or so) and check it again.
	The headlight of the vehicle is lit	The display is made dark at night to prevent the glare (When the headlight of the vehicle is lit in the daytime, the display gets dark).
When the VTR is connected, the image is disturbed.	Improper NTSC/PAL setting	Set the AUTO/PAL/NTSC properly according to the VTR.
There are red, green, and blue points in display.	-----	This is not a failure, but a phenomenon peculiar to a liquid crystal panel (The liquid crystal panel is produced according to technology with very high precision. Note that, though there are effective pixels of 99.99% or more, pixel missing or normally lit pixels account for 0.01%).

23. ERROR DISPLAY

If an error occurs, one of the following displays is displayed.
Take the measures described below to solve the problem.

DVD PLAYER

Display	Cause	Measure
Invalid Disc	A disc is caught inside the DVD deck and is not ejected.	This is a failure of DVD deck's mechanism and consult your store of purchase.
Invalid Disc	A disc cannot be played due to scratches, etc.	Replace with a non-scratched, non-warped disc.
Invalid Disc	A disc is loaded upside- down inside the DVD deck and does not play.	Eject the disc then reload it properly.
PARENTAL VIOLATION	Parental level error	Set the correct Parental level.
Disc Region incorrect	Region code error	Eject the disc, and replace correct region code disc.

If an error display other than the ones described above appears, press the Reset button. If the problem persists, turn off the power and consult your store of purchase.

* When the Reset button is pressed, frequencies of radio stations, titles, etc. stored in memory are cleared.

24. SPECIFICATIONS

FM Tuner

Frequency Range: 87.5 MHz to 108.0 MHz

Usable Sensitivity: 8 dB μ V

50dB Quieting Sensitivity: 14 dB μ V

Alternate Channel Selectivity: 70 dB

Stereo Separation: 25 dB (1 kHz)

Frequency Response: 30 Hz to 14 kHz

AM Tuner

Frequency Range: 531 kHz to 1,629 kHz

Usable Sensitivity: 30 dB μ V

DVD Player System

Digital Versatile Disc System with CDDA capable

Usable discs:

DVD video disc, Compact disc

Frequency Response: 20 Hz to 20 kHz

Sound/Noise Ratio: 95 dB A (1 W Ref)

Dynamic Range: 95 dB (1 kHz)

Distortion: 0.05%

Video system: NTSC/PAL

Audio/Video Input

Audio input voltage: $\leq 2 V_{rms}$

Video input voltage: $1.0 V_{p-p} @ 75\Omega$

Audio input sensitivity (at 2 V output)

High: 325 mV $_{rms}$

Mid: 650 mV $_{rms}$

Low: 1.3 V $_{rms}$

Audio/Video output

Video output voltage: $1.0 V_{p-p} @ 75\Omega$

Screen Size: 6.2" wide type

Pixels: 1,152,000

Resolution: 800 x 480 x 3 (RGB)

Bluetooth

Specification: Bluetooth Ver 2.1+EDR

Profile: HFP1.5(Hands Free Profile)

HSP1.0 (Headset Profile)

A2DP (Advanced Audio Distribution Profile)

AVRCP1.2,1.3,1.4 (AV Remote Control Profile)

Power Class: 2

MP3 mode

Bit rate: 32 kbps to 320 kbps

Sampling rate: 32 kHz, 44.1 kHz, 48 kHz

WMA mode

Bit rate: 64 kbps to 192 kbps

Sampling rate: 32 kHz, 44.1 kHz, 48 kHz

USB

Specification: USB 1.1/2.0 (FS)

Playable audio format:

MP3(.mp3): MPEG 2/Audio Layer-3

WMA(.wma): Ver 7/8/9.1/9.2

General

Power source voltage:

14.4 VDC (10.5 to 15.8 V allowable)

Ground: Negative

Current consumption: 4.0 A @1 W

Auto Antenna Rated Current: 500 mA less

Note:

- Specifications comply with JEITA Standards.
- Specifications and design are subject to change without notice for further improvement.

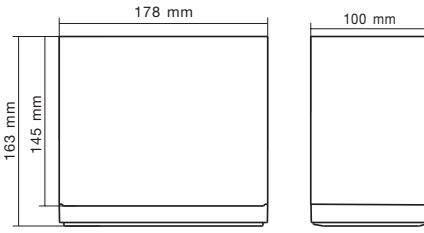

NX501A dimensions:
NX501A weight: 2.4 kg

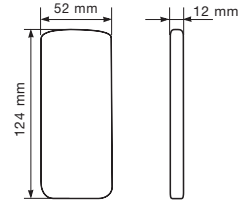

Remote Control dimensions:
Remote Control weight:
50g (including battery)

INSTALLATION / WIRE CONNECTION GUIDE

CONTENTS

1. Before Starting	56
2. Package Contents	56
3. General Cautions.....	57
4. Cautions On Installation	57
5. Installing The Main Unit.....	58
6. Cautions On Wiring	60
7. Wire Connections.....	61

1. Before Starting

1. This set is exclusively for use in cars with a negative ground 12 V power supply.
2. Read these instructions carefully.
3. Be sure to disconnect the battery “-” terminal before starting. This is to prevent short circuits during installation. (Figure 1)

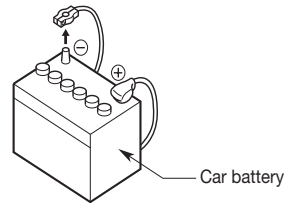

Figure 1

2. Package Contents

Main unit.....	1	Flush mount bolts	8
Wiring harness.....	1	Hexagon Head Screw	8
GPS antenna	1	AV cable	1
Clamp for GPS antenna's cable.....	3	Line out cable.....	1
Double face tape for GPS Antenna	1	Line in cable	1
Remote control unit.....	1	Rear Zone out cable.....	1
Battery (CR2025).....	1	SWI cable	1
(Installed in remote control)		External Microphone cable.....	1
Trim ring	1		
Cleaning cloth.....	1		
Owner's manual and			
Installation manual.....	2		
Electro tap	2		
2DIN trim ring 200mm wide	1		

3. General Cautions

1. Do not open the case. There are no user- serviceable parts inside. If you drop anything into the unit during installation, consult your dealer or an authorized Clarion service center.
2. Use a soft, dry cloth to clean the case. Never use a rough cloth, thinner, benzine, or alcohol etc. For tough dirt, apply a little cold or warm water to a soft cloth and wipe off the dirt gently.

4. Cautions on Installation

1. Prepare all articles necessary for installing the source unit before starting.
2. Install the unit within 30° of the horizontal plane. (Figure 2)
3. If you have to do any work on the car body, such as drilling holes, consult your car dealer beforehand.
4. Use the enclosed screws for installation. Using other screws can cause damage. (Figure 3)

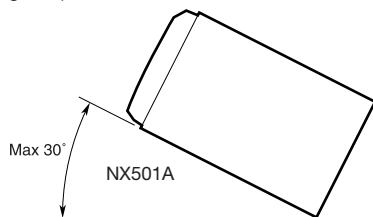

Figure 2

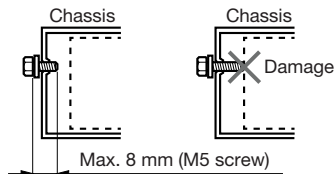

Figure 3

5. Installing the Main Unit

This unit is designed for fixed installation in the dashboard.

1. When installing the main unit in NISSAN vehicles, use the parts attached to the unit and follow the instructions in Figure 5.

When installing the main unit in TOYOTA vehicles, use the parts attached to the vehicle and follow the instructions in Figure 6.

2. Wire as shown in Section 7.
3. Reassemble and secure the unit in the dashboard and set the face panel and center panel.

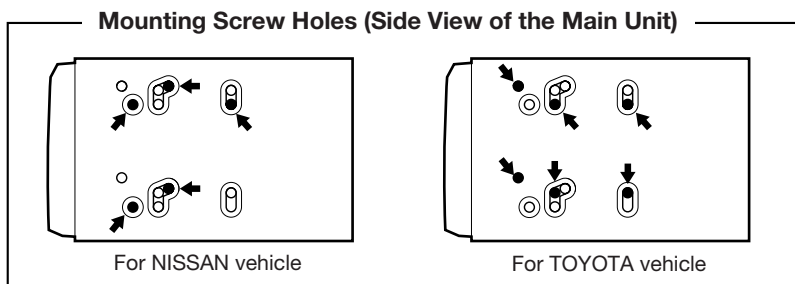

Figure 4

Installing the Main Unit in NISSAN Vehicle

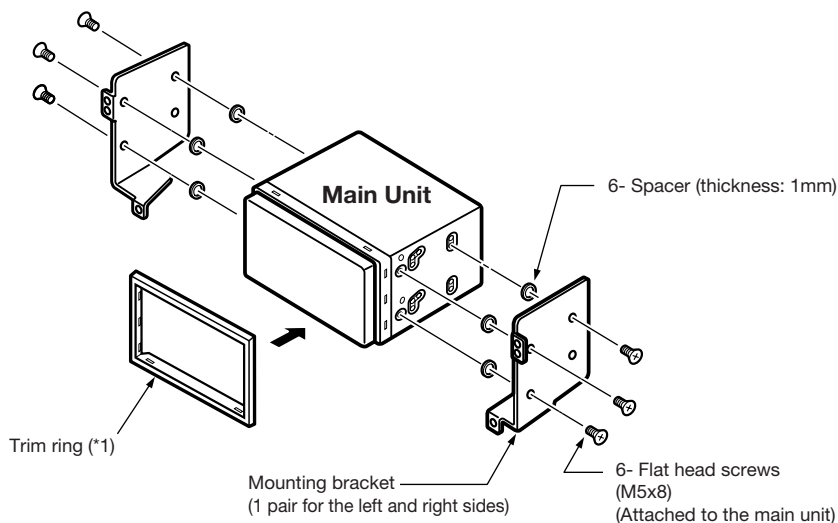

Figure 5

Note:

* 1: Position the face panel with its wide edge at the bottom. Fit the edge into the groove of the main unit.

Installing the Main Unit in TOYOTA Vehicle

Install by using parts attached to the vehicle. (Screws marked ★ are attached to the vehicle.)

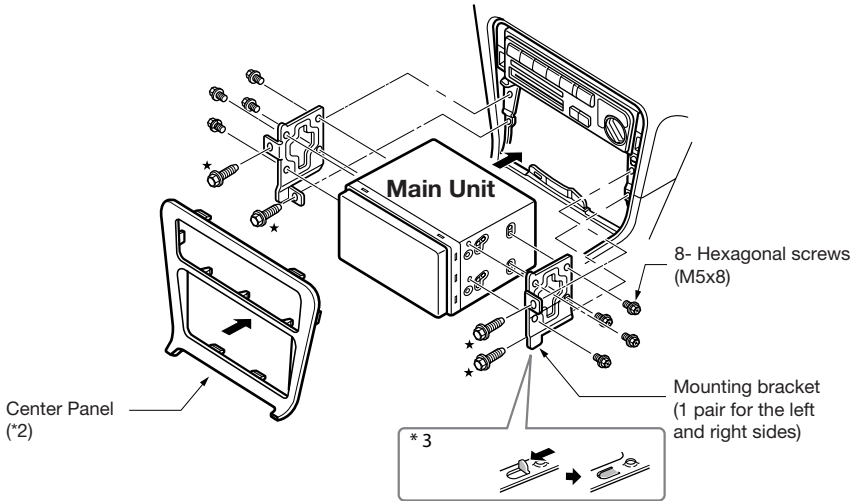
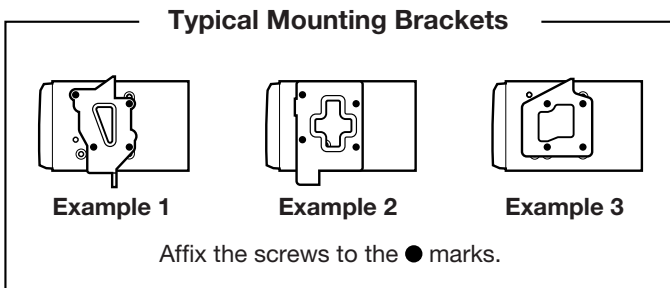

Figure 6

*2. Some panel openings are too small for the unit depending on the vehicle type and model. In such a case, trim the upper and lower sides of the panel frame by about 0.5 to 1.5 mm so the unit can be inserted smoothly.

*3. If a hook on the installation bracket interferes with the unit, bend and flatten it with a nipper or similar tool.



Vehicles other than NISSAN and TOYOTA

In some cases the center panel may require modification. (Trimming, filing, etc.)

• Removing the Main Unit

When the main unit is to be removed, disassemble it in the reverse of the order in "INSTALLING THE MAIN UNIT".

6. Cautions on Wiring

1. Be sure to turn the power off before wiring.
2. Be particularly careful where you route the wires.
Keep them well away from the engine, and exhaust pipe, etc. Heat may damage the wires.
3. If the fuse should blow, check to see if the wiring is correct.
If a fuse is blown, replace it with a new one of the same amperage rating as the original (15A FUSE).
4. To replace the fuse, remove the old fuse on the back of the unit and insert the new one. (Figure 7)

NOTE:

There are various types of fuse holder. Do not let the battery side touch other metal parts.

CAUTION

After the connection, fix the cord by a clamp or insulation tape for protection.

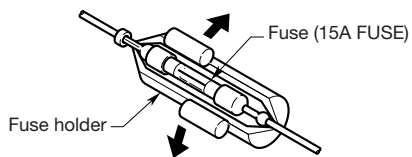

Figure 7

7. Wire Connections

Note:

- Before installing, be sure to disconnect the negative cable of the car battery.
- In the optional devices, the RCA cables and the Connector cables are separately-sold items.

NX501A

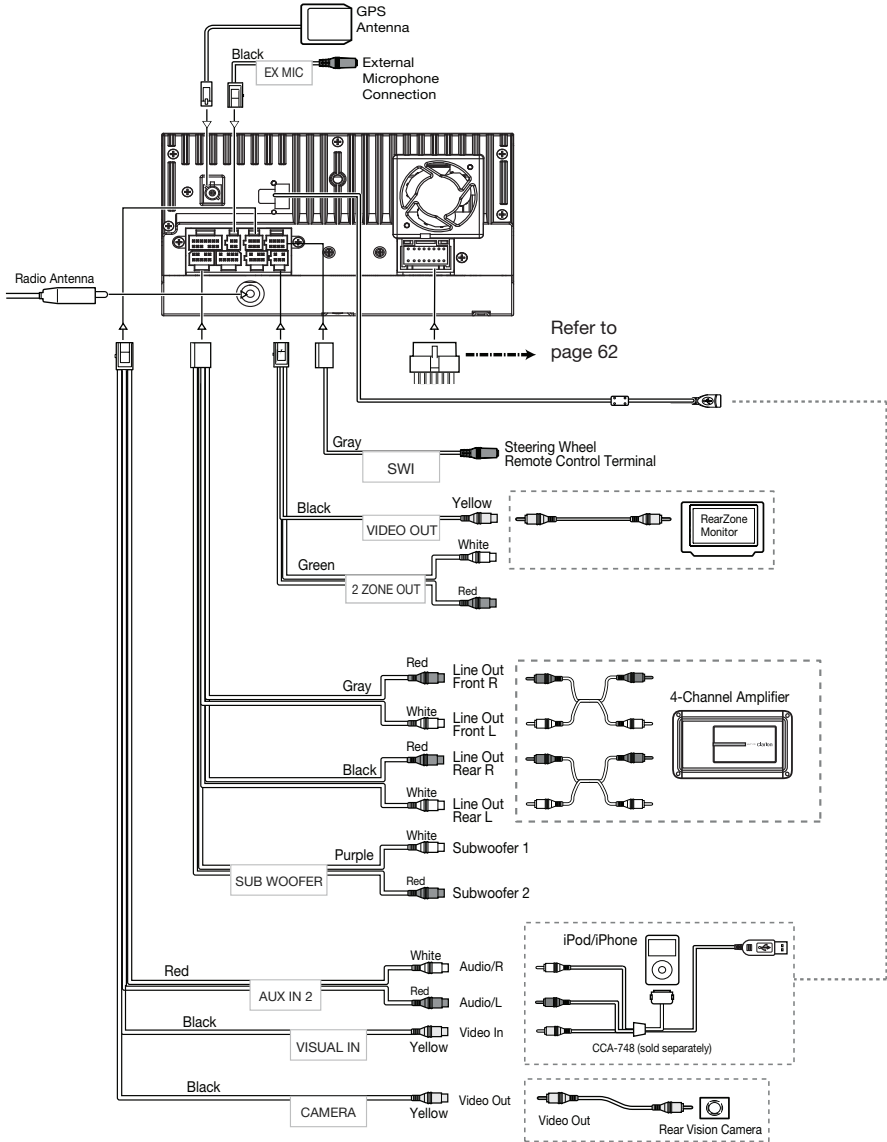

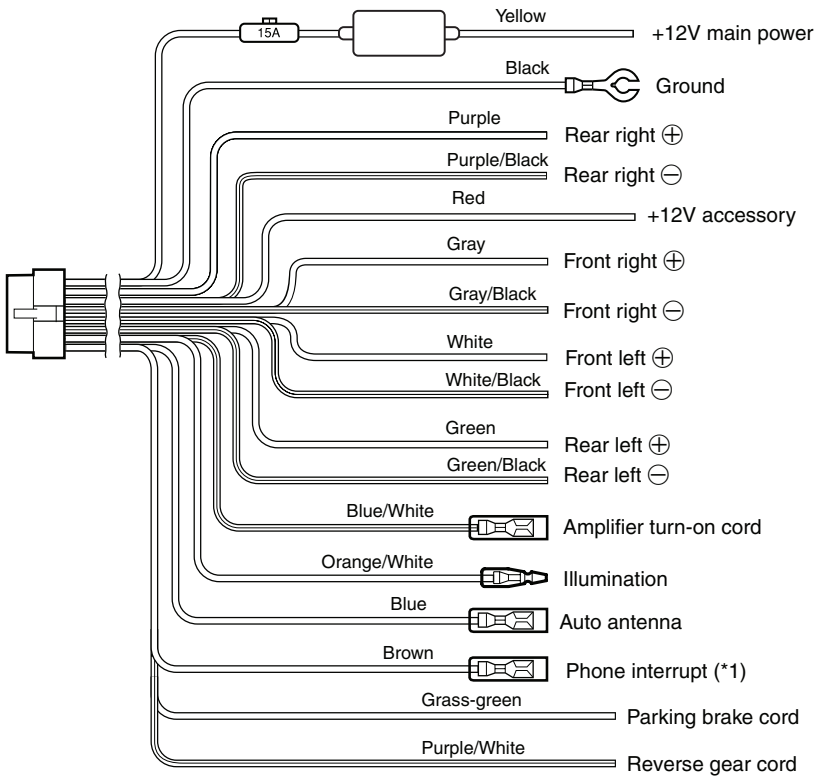
**Note:**

*1: Connecting the PHONE INTERRUPT terminal

The phone interrupt will mute the audio if the lead receives a negative or ground signal.

See next page for how to connect the parking brake cord.

Connecting the parking brake cord

Connect the cord to parking brake lamp ground in the meter panel.

Note:

- Connecting the parking brake cord to lamp ground allows you to watch iPod/iPhone video/DVD video/AV input when the parking brake is engaged.
- When the parking brake cord is not connected, the monitor will not show any video sources.
- If "AUDIO ONLY" appears on the screen just after turning on the ACC power of the car, release the parking brake while confirming safety, and then engage the parking brake again.

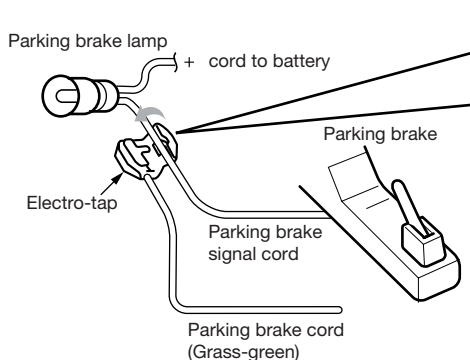

How to attach the electro-tap

1. Place the Parking brake cord at the stopper, and fold it back in the direction of the arrow
2. Pass the Parking brake signal cord through, and fold it back in the direction of the arrow.

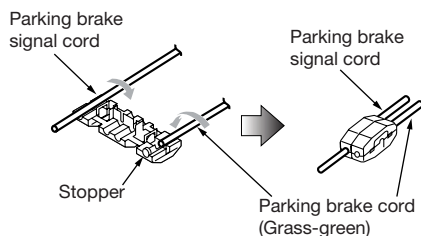

Connecting the accessories

• Connecting to the external amplifier

The external amplifiers can be connected to the 6 channel RCA output connections. Ensure that the connectors are not grounded or shorted to prevent damage to the unit.

• Connecting to iPod/iPhone device

The iPod/iPhone device can be connected to dedicated iPod/iPhone connection on the main unit. For detailed information, refer to the instruction sheet or manual for the iPod/iPhone cable.

Note:

- This unit may not support all functions of all iPod/iPhone devices.
- The iPod/ iPhone connection will charge your iPod/iPhone unless the iPod/iPhone battery is completely depleted. If the specified cord of the cellular phone is connected to the phone interrupt cord of the main unit, the audio mute is activated when cellular phone in use.
- Rear View Camera Warning:

For your safety, the driver should not view the Reversing Cameras while travelling in a forward direction, which is prohibited according to Australian Road Laws.

Clarion strongly recommends that when installing a Reverse Camera to this product, the camera's power source be derived from the vehicles reversing lamp circuit either directly (if suitable) or via a relay. This will ensure that the Rear View Camera can only be viewed while the vehicle is travelling in a reverse direction.

Clarion Co., Ltd.

All Rights Reserved. Copyright © 2011: Clarion Co., Ltd.
Printed in China / Imprime au Chiné / Impreso en China

clarion®

User Manual

NX501A

Clarion Mobile Map



clarion.naviextras.com

Terms and conditions "+3 Years Free Map Updates"

Congratulations on purchasing your new NX501A. As a part of Clarion's continued commitment to you our customer, an additional 3 years of map updates are included with your product at no additional charge. The term "+3 Years Free Map Updates" equates to 1 free scheduled map update per year in addition to the factory installed map software. The scheduling of the free map updates including starting date is to be determined by Clarion Australia in which the time between scheduled map updates may be less than or greater than 12 months.

You are strongly suggested to register your purchase via the Clarion free 3 Year Extended warranty program. Please visit <http://www.clarion.com.au> and click on the "Warranty Registration" tab. Not only will this extend your parts and labour warranty, it will enable Clarion to notify you directly for upcoming map updates, map update scheduling and firmware updates (if applicable). If you do not register via the extended warranty program, it is up to you to contact Clarion or your local Clarion reseller about update scheduling. If you fail to update your product for any of the 3 map update cycles, no refunds, compensation or additional updates will be offered, as you are instructed to register your product to receive update scheduling information. Clarion takes no responsibility if your map data becomes corrupted during the map update process. You are instructed to follow instructions given by Naviextras at all times during the process of updating your map software. If your MicroSD card is lost or damaged, a replacement will be made available to you however this will be a chargeable item as a new map licence will have to be issued.

This document is the detailed description of the navigation software. You can easily discover Clarion Mobile Map while you are using it; however, we still recommend that you read this manual to fully understand the screens and make the most out your device and it's features.

Table of contents

1 Warnings and Safety information	6
2 Getting started.....	7
2.1 <i>Buttons and other controls on the screen</i>	8
2.1.1 Using keyboards	10
2.1.2 Beyond single screen tap	11
2.2 <i>Map screen</i>	12
2.2.1 Navigating on the map	12
2.2.2 Position markers	14
2.2.2.1 <i>Vehimarker and Lock-on-Road</i>	14
2.2.2.2 <i>Selected map location (Cursor) and selected map object</i>	14
2.2.3 Objects on the map	14
2.2.3.1 <i>Streets and roads</i>	14
2.2.3.2 <i>Turn preview and Next street</i>	14
2.2.3.3 <i>Lane information and Signposts</i>	16
2.2.3.4 <i>Junction view</i>	16
2.2.3.5 <i>3D object types</i>	16
2.2.3.6 <i>Elements of the active route</i>	17
2.2.3.7 <i>Traffic events</i>	17
2.2.4 Manipulating the map	18
2.2.5 Quick menu.....	20
2.2.6 Checking the details of the current position (Where Am I?)	22
2.3 <i>Navigation menu</i>	24
3 Navigating	25
3.1 <i>Selecting the destination of a route</i>	25
3.1.1 Entering an address or a part of the address.....	25
3.1.1.1 <i>Entering an address</i>	26
3.1.1.2 <i>Entering an address starting with the street name</i>	28
3.1.1.3 <i>Entering the midpoint of a street as the destination</i>	30
3.1.1.4 <i>Selecting an intersection as the destination</i>	31
3.1.1.5 <i>Selecting a city/town/suburb centre as the destination</i>	32
3.1.1.6 <i>Entering an address with a postal code</i>	34
3.1.1.7 <i>Tips on entering addresses quickly</i>	36
3.1.2 Selecting the destination from the Places of Interest	36
3.1.2.1 <i>Quick search for a Place of Interest</i>	36
3.1.2.2 <i>Searching for a Place of Interest using preset categories</i>	38
3.1.2.3 <i>Searching for a Place of Interest by category</i>	40
3.1.2.4 <i>Searching for a Place of Interest by name</i>	42
3.1.2.5 <i>Searching for a Place of Interest by its phone number</i>	45
3.1.2.6 <i>Selecting nearby assistance from 'Where Am I?'</i>	46
3.1.3 Selecting a map location as the destination	47
3.1.4 Selecting the destination from your Favourites	48

3.1.5	Selecting your Home location.....	49
3.1.6	Selecting a recent destination from the History	50
3.1.7	Entering the coordinate of the destination	51
3.1.8	Navigate to a location stored in a photo.....	52
3.1.9	Building a route from the list of destinations (Create Route)	53
3.2	<i>Viewing the entire route on the map</i>	54
3.3	<i>Checking route parameters and accessing route related functions</i>	55
3.4	<i>Modifying the route</i>	56
3.4.1	Selecting a new destination when already having a route: New Route, Waypoint or Final Destination.....	56
3.4.2	Setting a new starting position for the route	56
3.4.3	Editing the list of destinations (Edit Route).....	58
3.4.4	Pausing the active route	58
3.4.5	Cancelling the active route	59
3.4.6	Checking route alternatives when planning the route	59
3.4.7	Checking route alternatives for an existing route	60
3.4.8	Changing the vehicle used in route planning	61
3.4.9	Changing the road types used in route planning	62
3.5	<i>Saving a location as a Favourite destination</i>	63
3.6	<i>Saving a location as an alert point</i>	63
3.7	<i>Editing an alert point</i>	64
3.8	<i>Watching the simulation of the route</i>	65
4	Reference Guide	66
4.1	<i>Concepts</i>	66
4.1.1	Smart Zoom	66
4.1.2	Daytime and night colour themes	66
4.1.3	Route calculation and recalculation	66
4.1.4	Green routing	68
4.1.5	Road safety cameras and other proximity alert points	69
4.1.6	Speed limit warning.....	69
4.1.7	Traffic information in route planning	70
4.1.7.1	<i>Real-time traffic information (TMC)</i>	70
4.2	<i>'More' menu</i>	71
4.3	<i>Settings menu</i>	73
4.3.1	Sound and Warnings.....	74
4.3.2	Customise Quick menu	75
4.3.3	Traffic settings	75
4.3.4	Route settings.....	76
4.3.5	Green routing settings.....	78
4.3.6	Map settings.....	79
4.3.7	Visual guidance settings	80

4.3.8 Display settings.....	80
4.3.9 Regional settings.....	81
4.3.10 Trip monitor settings.....	81
5 Glossary.....	81
6 End User Licence Agreement.....	83
7 Copyright note.....	86
8 SUNA Licence	87
9 Naviextras (Map Update Process)	88

1 Warnings and Safety information

The navigation system helps you find your way to your destination with a connected GPS receiver. Clarion Mobile Map does not transmit your GPS position; others cannot track you.

It is important that you look at the display only when it is safe to do so. If you are the driver of the vehicle, we recommend that you operate Clarion Mobile Map before you start your journey. Plan the route before your departure and stop if you need to change the route.

You must obey the traffic signs and follow the road geometry. If you deviate from the recommended route, Clarion Mobile Map changes the instructions accordingly.

Never place NX501A where it obstructs the driver's view, where it is in the deployment zone of an airbag or where it might cause injuries in an accident.

For more information, consult the End User Licence Agreement (page 85).

2 Getting started

Clarion Mobile Map is optimised for in-car use. You can use it easily by tapping the screen buttons and the map with your fingertips.

When using the navigation software for the first time, an initial setup process starts automatically. Do as follows:

1. Select the written language of the application interface. Later you can change it in Regional settings (page 82).



2. Read the End User Licence Agreement. Tap  to continue.



3. The Configuration wizard starts. Tap  to continue.

4. Select the language and speaker used for voice guidance messages. Later you can change it in Sound and Warnings settings (page 75).



5. If needed, modify the time format and unit settings. Later you can change them in Regional settings (page 82).

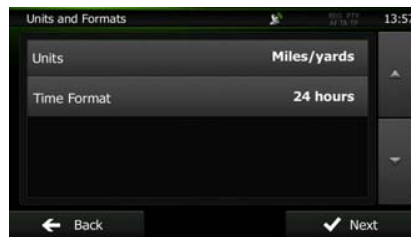

6. If needed, modify the default route planning options. Later you can change them in Route settings (page 77).



7. The initial setup is now complete. The Configuration wizard can be restarted later from the Settings menu (page 74).
8. Clarion Mobile Map offers you to watch the tutorial that leads you through the basic

steps of navigation. Tap **Run Tutorial** if you would like to get an instant understanding of the functions of your software. You can run it later if you choose









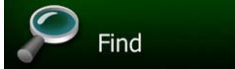
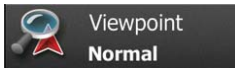

After the initial setup, the Map screen appears and you can start using Clarion Mobile Map.

2.1 Buttons and other controls on the screen

When you are using Clarion Mobile Map, you usually tap buttons on the touch screen.









You only need to confirm selections or changes if the application needs to restart, it needs to perform a major reconfiguration, or you are about to lose some of your data or settings. Otherwise, Clarion Mobile Map saves your selections and applies the new settings without confirmation as soon as you use the controls.

Type	Example	Description	How to use it
Button		Tap it to initiate a function, to open a new screen, or to set a parameter.	Tap it once.
Button with value		Some buttons display the current value of a field or setting. Tap the button to change the value. After the change, the new value is shown on the button.	Tap it once.
Icon		Shows status information.	Some icons also function as a button. Tap them once.

List		<p>When you need to select from several options, they appear in a list.</p>	<p>Grab the list anywhere and slide your finger up or down. Depending on the speed of the sliding, the list will scroll fast or slow, only a bit or till the end.</p> <p>Alternatively, move between pages with the  and  buttons and tap the value that you want.</p>
Radio button		<p>When there are only a few choices, radio buttons may be used instead of lists. Only one value can be selected.</p>	<p>Tap one of the buttons to select a new value.</p>
Switch		<p>When there are only two choices, a checkmark shows whether the feature is enabled.</p>	<p>Tap it to turn the switch on or off.</p>
Slider		<p>When a feature can be set to different values in a range, Clarion Mobile Map shows an indicator on a gauge that displays and sets the value.</p>	<ul style="list-style-type: none"> • Drag the handle to move the slider to its new position. • Tap the slider where you want the handle to appear; the thumb jumps there.
Virtual keyboard		<p>Alphabetic and alphanumeric keyboards to enter text and numbers.</p>	<p>Each key is a touch screen button.</p>











2.1.1 Using keyboards

You only need to enter letters or numbers when you cannot avoid it. You can type with your fingertips on the full-screen keyboards and you can switch between various keyboard layouts, for example English, Greek or numerical.

Task	Instruction
Switching to another keyboard layout, for example from an English keyboard to a Greek keyboard	Tap the  More button and select the new keyboard layout from the list.
Correcting your entry on the keyboard	Tap  to remove the unneeded character(s). Tap and hold the button to delete several characters or the entire input string.
Entering a space, for example between a first name and a family name or in multi-word street names	Tap the  button at the bottom centre of the screen.
Entering numbers and symbols	Tap  to switch to a keyboard offering numeric and symbol characters.
Finalising the keyboard entry (accepting the suggested search result)	Tap  .
Finalising the keyboard entry (opening the list of search results)	Tap  Results .
Finalising the keyboard entry (saving your input)	Tap  Done .
Cancelling the keyboard entry (returning to the previous screen)	Tap  Back .

2.1.2 Beyond single screen tap

You usually need to tap the screen only once. However, some useful features can be accessed with combined touch screen tapping. Those are the following:

Action	Details
Tapping and holding the screen	<p>Tap and keep pressing the following buttons to reach extra functions:</p> <ul style="list-style-type: none"> • Tap and hold  on list and menu screens: the Map screen appears. • Tap and hold any of the , , , , , and  buttons on the Map screen: you can rotate, tilt or scale the map continuously. • Tap and hold  on keyboard screens: you can delete several characters quickly. • Tap and hold  or  in long lists: you can scroll pages continuously.
Gestures (drag&drop)	<p>You need to drag and drop the screen only in cases like:</p> <ul style="list-style-type: none"> • Moving the handle on a slider. • Scrolling the list: grab the list anywhere and slide your finger up or down. Depending on the speed of the sliding, the list will scroll fast or slow, only a bit or till the end. • Moving the map in map browsing mode: grab the map, and move it in the desired direction.

2.2 Map screen

2.2.1 Navigating on the map

The Map screen is the most frequently used screen of Clarion Mobile Map.

A small live map is displayed on the startup screen, the Navigation menu, as a part of the

Show Map

button.



Show Map

To enlarge this small map and open the Map screen, tap

This map shows the current position (the Vehimarker, a red arrow by default), the recommended route (an orange line), and the surrounding map area.

When there is no GPS position, the Vehimarker is transparent. It shows your last known position.

You see coloured dots circling around a satellite symbol in the top left corner. The more green dots you see, the closer you are to get the valid GPS position.

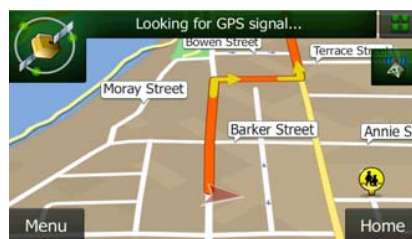

When GPS position is available, the Vehimarker is displayed in full colour, now showing your current position.



There are screen buttons and data fields on the screen to help you navigate. During navigation, the screen shows route information.

By default, only one data field is displayed in the bottom right corner. Tap this field to see all route data fields.



Tap any of the data fields to suppress others and display only the selected one. The data fields are different when you are navigating an active route and when you have no specified destination (the orange line is not displayed).

Default data fields when cruising without a destination (tap and hold any of the fields to change its value):

Field	Description
Speed 61 km/h	Shows your current speed given by the GPS receiver.
Speed Limit 70 km/h	Shows the speed limit of the current road if the map contains it.
Time 17:11	Shows the current time corrected with time zone offset. The accurate time comes from the GPS satellites, and the time zone information comes from the map or it can be set manually in Regional settings. (The current time is always displayed in the top left corner of menu screens.)

Default data fields when navigating a route (tap and hold any of the fields to change its value):

Field	Description
Distance 16.9 km	Shows the distance you need to travel on the route before reaching your final destination.
Time Left 0:16	Shows the time needed to reach the final destination of the route based on information available for the remaining segments of the route. Historical traffic data or traffic patterns are also taken into account whenever such information exists. If NX501A is capable of receiving live traffic information, the calculation takes into account traffic delays affecting your route if they are received. However, this calculation is rarely accurate. Historical traffic data can also be taken into account if data is available.
Arrival Time 17:22	Shows the estimated arrival time at the final destination of the route based on information available for the remaining segments of the route. Historical traffic data or traffic patterns are also taken into account whenever such information exists. If NX501A is capable of receiving live traffic information, the calculation takes into account traffic delays affecting your route if they are received. However, this calculation is rarely accurate. Historical traffic data can also be taken into account if data is available.

2.2.2 Position markers

2.2.2.1 Vehimarker and Lock-on-Road

When your GPS position is available, Clarion Mobile Map marks your current position with the Vehimarker. By default, this marker is a red arrow, but you can change this icon in Settings.

The Vehimarker may not show your exact GPS position and heading. If roads are near, it is aligned to the nearest road to suppress GPS position errors, and the direction of the icon is aligned to the direction of the road.

2.2.2.2 Selected map location (Cursor) and selected map object

You can mark a map location in the following ways:

- Tap the map when navigating,
- Tap the map when you are asked to confirm the destination at the end of a search, or
- Tap the map in Find on Map (page 47)

When a map location is selected, the Cursor appears at the selected point on the map. The

Cursor is displayed with a radiating red dot () to make it visible at all zoom levels.

The location of the Cursor can be used as the destination of the route, a new alert point, you can search for Places around it, or you can save this location as one of your Favourite destinations.

You can also select some of the objects on the map. If you tap the map at the icon of a Place of Interest or an alert point, the object will be selected (you see a red circling border around the object), and you can get information about this object or use it as a route point.

2.2.3 Objects on the map

2.2.3.1 Streets and roads

Clarion Mobile Map shows the streets in a way that is similar to how the paper road maps show them. Their width and colours correspond to their importance: you can easily tell a motorway from a small street.

2.2.3.2 Turn preview and Next street

When navigating a route, the top section of the Map screen shows information about the next route event (manoeuvre) and the next street or the next city/town/suburb.



There is a field in the top left corner that displays the next manoeuvre. Both the type of the event (turn, roundabout, exiting motorway, etc.) and its distance from the current position are displayed.

A smaller icon shows the type of the second next manoeuvre if it is near the first one. Otherwise, only the next manoeuvre is displayed.

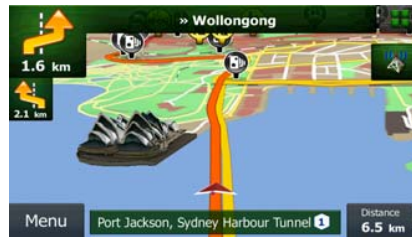

Most of these icons are very intuitive. The following table lists some of the frequently shown route events. The same symbols are used in both fields:

Icon	Description
	Turn left.
	Turn right.
	Turn back.
	Bear right.
	Turn sharp left.
	Keep left.
	Continue straight in the intersection.
	Go left on the roundabout, 3rd exit (next manoeuvre).
	Enter roundabout (second next manoeuvre).
	Enter motorway.
	Exit motorway.
	Board ferry.
	Leave ferry.
	Approaching a waypoint.
	Approaching the destination.

2.2.3.3 Lane information and Signposts

When navigating on multi-lane roads it is important to take the appropriate lane in order to follow the recommended route. If lane information is available in the map data, Clarion Mobile Map displays the lanes and their directions using small arrows at the bottom of the map. Highlighted arrows represent the lanes you need to take.

Where additional information is available, signposts substitute arrows. Signposts are displayed at the top of the map. The colour and style of the signposts are similar to the real ones you can see above road or by the roadside. They show the available destinations and the number of the road the lane leads to.

All signposts look similar when cruising (when there is no recommended route). When navigating a route, only the signpost that points to the lane(s) to be taken is displayed in vivid colours; all others are darker.

If you want to hide the currently displayed signposts, tap any of them and the normal Map screen returns until new signpost information is received.

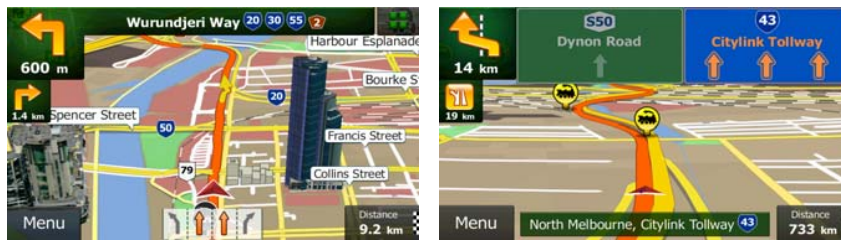

2.2.3.4 Junction view

If you are approaching a motorway exit or a complex intersection and the needed information exists, the map is replaced with a 3D view of the junction. The lanes you need to take are displayed with arrows. Signposts can also be present if information is available.

If you want to hide the currently displayed junction, tap the picture and the Map screen returns.



2.2.3.5 3D object types



Clarion Mobile Map supports the following 3D object types:

Type	Description
3D terrain	3D terrain map data shows changes in terrain, elevations or depressions in the land when you view the map in 2D, and use it to plot the route map in 3D when you navigate. Hills and mountains are shown in the background of the 3D map, and illustrated by colour and shading on the 2D map.

Elevated roads	Complex intersections and vertically isolated roads (such as overpasses or bridges) are displayed in 3D.
3D landmarks	Landmarks are 3D artistic or block representations of prominent or well-known objects.
3D buildings	3D block representation of full city building data containing actual building size and position on the map.

2.2.3.6 Elements of the active route

Clarion Mobile Map shows the route in the following way:

Symbol	Name	Description
	Current GPS position and Start point	Your current position displayed on the map. If roads are near, it is aligned to the nearest road. Normally if GPS position is available, the route starts from the current position. If there is no valid GPS position, Clarion Mobile Map uses the last known position as the start point.
	Waypoint (intermediate destination)	An intermediate destination of the route before reaching the final destination.
	Destination (end point)	The final destination of the route.
	Route colour	The route always stands out with its colour on the map, both in daytime and in night colour mode.
	Streets and roads that are excluded from the navigation	You can choose whether you want to use or avoid certain road types (page 77). However, when Clarion Mobile Map cannot avoid such roads, the route will include them and it will show them in a colour that is different from the route colour.
	Streets and roads that are affected by traffic events	Road segments may be affected by traffic events received. These streets and roads are displayed in an alternate colour, and small symbols displayed along the route show the type of the traffic event.

2.2.3.7 Traffic events

Road segments affected by traffic events are displayed with an alternate colour on the map, and small symbols above the road show the nature of the event:

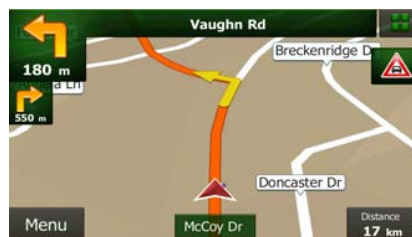

Tap  to open the Traffic Summary screen.



Tap  to open the list of traffic events:



Now tap any of the list items to see its details, and to display the affected road segment in its full length on the map:









 **Note!** If there are traffic events on the recommended route that the application has not



bypassed, the  icon will open the list of significant traffic events to let you quickly check them.

2.2.4 Manipulating the map

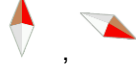
Tap the map anywhere to browse it during navigation. The map stops following the current position (the Vehimarker, a red arrow by default is not locked in a fixed position on the screen any more) and control buttons appear to help you modify the map view.



Action	Button(s)	Description
Moving the map with drag&drop	No buttons	You can move the map in any direction: tap and hold the map, and move your finger towards the direction you want to move the map.
Zooming in and out		<p>Changes how much of the map is displayed on the screen.</p> <p>Clarion Mobile Map uses high-quality vector maps that let you examine the map at various zoom levels, always with optimised content. It always displays street names and other text with the same font size, never upside-down, and you only see the streets and objects that you need.</p> <p>Map scaling has a limit in 3D map view mode. If you zoom out further, the map switches to 2D view mode.</p> <p>Tap the button once to modify the view in large steps, or tap and hold the button to modify it continuously and smoothly.</p>
Tilting up and down		<p>Changes the vertical view angle of the map in 3D mode.</p> <p>Tap the button once to modify the view in large steps, or tap and hold the button to modify it continuously and smoothly.</p>
Rotating left and right		<p>Changes the horizontal view angle of the map.</p> <p>Tap the button once to modify the view in large steps, or tap and hold the button to modify it continuously and smoothly.</p>
2D or 3D view		Tap this button to switch between the 3D perspective and 2D top-down map view modes.
Compass in 2D map view mode		The direction of the compass shows North. Tap the button to switch to North-up view, and then tap again to rotate the map in the previous direction.
Compass in 3D map view mode		The direction of the compass shows North. Tap the button to switch to North-up view, and then tap again to rotate the map in the previous direction.
Location information		Tap this button to open a new screen with information about the selected map point, the Cursor.

Return to normal navigation		Tap this button to move the map back to follow the current GPS position. Automatic map rotation is also re-enabled. The map manipulation buttons disappear and navigation continues.
Additional options		Tap this button to open a list of additional features like saving the Cursor as a Favourite destination, or searching for Places around the Cursor.
Select destination		Tap this button to select the Cursor as a new destination. The route is automatically calculated.

2.2.5 Quick menu



The Quick menu is a selection of controls and functions that are frequently needed during navigation. It can be opened directly from the Map screen by tapping .









The menu will close after a few seconds of inactivity or if you tap .

Most of these functions are shortcuts. They are accessible from the menu system.

There are more functions available than the number of buttons in the menu. In Settings, you can choose the function of each button (page 76). The following options are available:

Button	Description	Shortcut for
	This function lets you search for a Place along your route or around your current location if there is no route calculated.	Find / Find Places / Quick Search (page 36)
	This button opens the list of your Favourite destinations.	Find / Favourite (page 48)
	This button opens the History list. You can select one of your previous destinations.	Find / History (page 50)

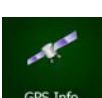
	This button opens the route editing function.	My Route / Edit Route
	This button opens the route related settings.	More / Settings / Route Settings (page 77)
	This button opens the map related settings.	More / Settings / Map Settings (page 80)
	This button opens a special screen with information about the current position and a button to search for nearby emergency or roadside assistance. For details, see the next chapter.	n/a
	This button cancels the route and stops navigation. The button is replaced with the next one if waypoints are given.	My Route / Cancel Route (page 59)
	This button skips the next waypoint from the route.	
	This button opens a 2D map scaled and positioned to show the entire route.	My Route / Overview (page 54)
	This button opens the Visual Guidance settings screen.	More / Settings / Visual Guidance (page 81)
	This button opens the Traffic Summary screen.	Tap the Traffic icon in the Navigation menu or on the Map screen.
	This button lets you bypass parts of the recommended route.	My Route / Avoidances
	This button opens the Trip Monitor screen where you can manage your previously saved trip logs and track logs.	More / Trip Monitor (page 82)
	This button opens the list of manoeuvres (the itinerary).	Tap the top of the Map screen during navigation.

	With this function you can save the active route for later use.	My Route / More / Save Route
	With this function you can replace the active route with a previously saved route.	My Route / More / Load Route
	With this function you can search for Places of Interest in various different ways.	Find / Find Places (page 36)
	This button opens the Map screen and starts simulating the active route.	My Route / More / Simulate Navigation (page 65)
	This button opens the GPS Information screen with satellite position and signal strength information.	Tap the top of the Map screen when there is no GPS reception
	This button offers your Home location as a destination.	

2.2.6 Checking the details of the current position (Where Am I?)

This screen contains information about the current position (or about the last known position if GPS reception is not available) and a button to search for useful Places nearby.





You can access this screen from the map in one of the following ways:

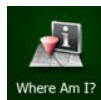

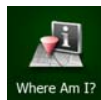
- If the current street is displayed below the Vehimarker (the current position on the map), tap it to open the Where Am I? screen.



- Open the Quick menu and tap the  button.

Information on this screen:

-  : Latitude and Longitude (coordinate of the current position in WGS84 format).

- : Altitude (elevation information coming from the GPS receiver - often inaccurate).
- : House number on the left.
- : House number on the right.
- In the middle of the screen you can see whether the position is current, or the time left since it was last updated.
- Address details (when available) of the current position are also displayed at the bottom.

You can also perform some actions on this screen:

Tap  to save the current position as a Favourite destination.

You can also search for assistance near your current position. Tap  to open a new screen for the Quick search:

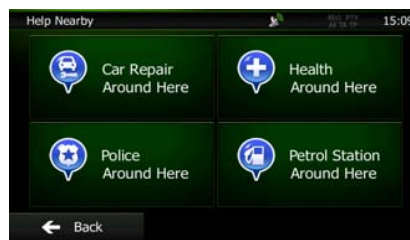

The following services can be searched around the current position or the last known position:

- : Car repair and roadside assistance services
- : Medical and emergency services
- : Police stations
- : Petrol stations





Tap any of the buttons, select a Place from the list, and navigate to it.

2.3 Navigation menu

You can reach all parts of Clarion Mobile Map from the Navigation menu.

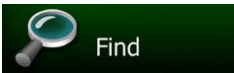
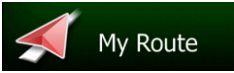

You have the following options:

- Tap  to select your destination by entering an address or selecting a place of interest, a location on the map or one of your Favourite destinations. You can also look up your recent destinations from the Smart History or enter a coordinate.
- Tap  to display the route parameters and the route in its full length on the map. You can also perform route-related actions such as editing or cancelling your route, setting a start point for the route, picking route alternatives, avoiding parts of the route, simulating navigation or adding the destination to your Favourites.
- Tap  to customise the way the navigation software works, watch the Tutorial, simulate demo routes, or to run some additional applications.
- Tap  to start navigating on the map. The button itself is a miniature live map that shows your current position, the recommended route and the surrounding map area. Tap the button to enlarge the map to the full screen.
- Tap  to open the Traffic Summary screen.

3 Navigating

You can set up your route in different ways:

- If you need a route for immediate navigation, you can select the destination and start navigating to it right away (normal navigation).
- You can also plan a route independently of your current GPS position or even without GPS reception (to achieve this, you need to turn off the GPS receiver and set a new starting point in My Route / Edit Route by tapping the flag icon at the current position).

You can plan routes with multiple destinations. Select the first destination. Then select a second destination and add it to your route to create a multi-point route. You can add as many destinations to your route as you like.

3.1 Selecting the destination of a route

Clarion Mobile Map offers you several ways of choosing your destination:

- Enter a full address or a part of an address, for example a street name without a house number or the names of two intersecting streets (page 26 & 27).
- Enter an address with postal code (page 34). This way you do not need to select the name of the settlement and the search for street names might be faster as well.
- Use a built-in Place of Interest as your destination (page 36).
- Select a location on the map with the Find on Map feature (page 47).
- Use a previously saved Favourite destination (page 48).
- Select a location from the History of previously used destinations (page 50).
- Enter the coordinate of the destination.
- Use the location where a photo was taken.

3.1.1 Entering an address or a part of the address

If you know at least a part of the address, it is the quickest way to select the destination of the route.



Using the same screen, you can find an address by entering:

- the exact address, including house number
- the centre of a city/town/suburb
- an intersection
- the midpoint of a street
- any of the above, starting the search with the postal code (page 34)

3.1.1.1 Entering an address

To enter an address as the destination, do as follows:

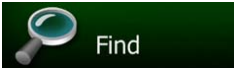

1. If you are on the Map screen, tap  to return to the Navigation menu.

2. In the Navigation menu, tap the following buttons: , .
3. By default, Clarion Mobile Map proposes the country and state where you are. If

needed, tap , enter the first few letters of the destination country or state on the keyboard, and select one from the list. If you select a country without a state, you can search for a city/town/suburb in all its states.



4. Select a new city/town/suburb:

- a. Tap . The city/town/suburb of your current location is offered by default. For a local search, tap  to accept it, otherwise continue with entering the destination city/town/suburb name.
- b. Start entering the name of the city/town/suburb on the keyboard.
- c. Find the city/town/suburb you need:

- The most likely city/town/suburb name is always shown in the input field.

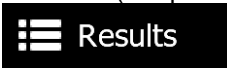

To accept it, tap .

- If the desired name does not show up, the names that match the string appear in a list after entering a couple of characters (to open the list of

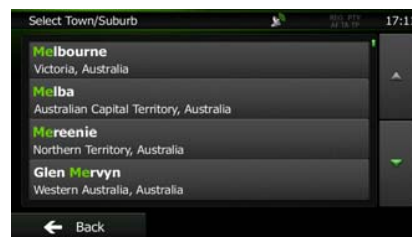
results before it appears automatically, tap ). Select the city/town/suburb from the list.





5. Enter the street name:





- a. Tap **Street**.
- b. Start entering the street name on the keyboard.
- c. Find the street you need:
 - The most likely street name is always shown in the input field. To accept it, tap .
 - If the desired name does not show up, the names that match the string appear in a list after entering a couple of characters (to open the list of results before it appears automatically, tap  **Results**). Select the street from the list.





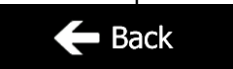

6. Enter the house number:

- a. Tap **<House Number>**.
- b. Enter the house number on the keyboard. (To enter letters, tap .
- c. Tap  to finish entering the address. (If the entered house number cannot be found, the midpoint of the street is selected as the destination.)

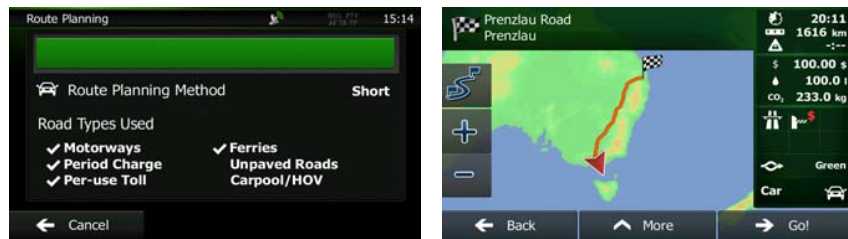

7. A full screen map appears with the selected point in the middle. If necessary, tap the map somewhere else to modify the destination. The Cursor () appears at the new location. Tap  to confirm the destination, or tap  to select a different destination.
8. After a short summary of the route parameters, the map appears showing the entire route. The route is automatically calculated. Tap  to modify route parameters, or tap  and start your journey.

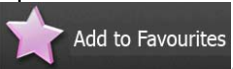

Tip! If you know that you will use this destination frequently, before tapping  to confirm the destination, put it on the list of your Favourites first: tap  then , give a name for the new Favourite, and tap  to save the location. The map with the destination returns automatically. Now you can start your journey.

3.1.1.2 Entering an address starting with the street name

You can leave the city/town/suburb name empty and start the search with the street name. This way you can search in all streets of a state. Do as follows:

1. If you are on the Map screen, tap  to return to the Navigation menu.



2. In the Navigation menu, tap the following buttons:

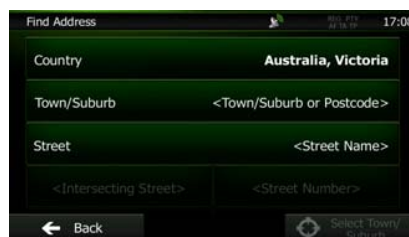

3. By default, Clarion Mobile Map proposes the country and state where you are. If needed, tap the button with the name of the country, enter the first few letters of the destination country or state on the keyboard, and select a country and state from the list. If you select the country without a state, this function cannot work.



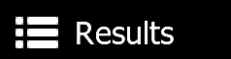

4. Enter the street name:

- a. Tap .
- b. Start entering the street name on the keyboard.
- c. Find the street you need:
 - The most likely street name is always shown in the input field. To accept it, tap .



- If the desired name does not show up, the names that match the string appear in a list after entering a couple of characters (to open the list of results before it appears automatically, tap ). Select the street from the list.



5. Enter the house number:

- Tap .
- Enter the house number on the keyboard. (To enter letters, tap .
- Tap  to finish entering the address. (If the entered house number cannot be found, the midpoint of the street is selected as the destination.)



- A full screen map appears with the selected point in the middle. If necessary, tap the map somewhere else to modify the destination. The Cursor () appears at the new location. Tap  to confirm the destination, or tap  to select a different destination.

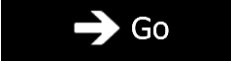

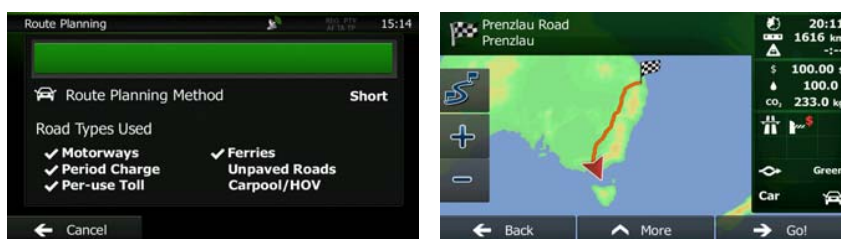
- After a short summary of the route parameters, the map appears showing the entire route. The route is automatically calculated. Tap  to modify route parameters, or tap  and start your journey.



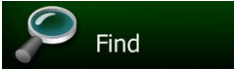

3.1.1.3 Entering the midpoint of a street as the destination

You can navigate to the midpoint of a street if the house number is not available:

1. If you are on the Map screen, tap  to return to the Navigation menu.

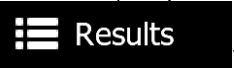

2. In the Navigation menu, tap the following buttons: , 
3. Select the country, state and settlement as described earlier (page 26).
4. Enter the street name:

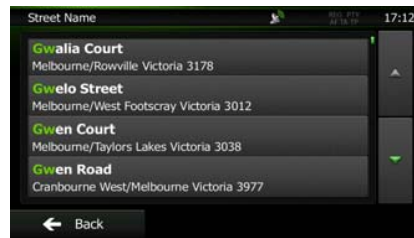
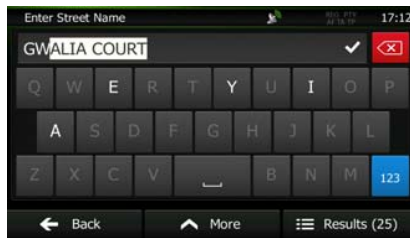

- a. Tap .
- b. Start entering the street name on the keyboard.
- c. Find the street you need:
 - The most likely street name is always shown in the input field. To accept it, tap .
 - If the desired name does not show up, the names that match the string appear in a list after entering a couple of characters (to open the list of results before it appears automatically, tap ). Select the street from the list.

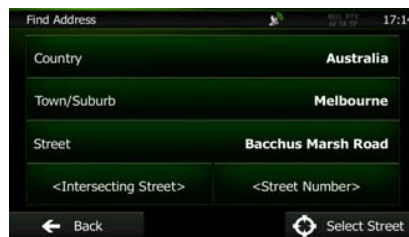

5. Instead of entering the house number, tap . The midpoint of the street is selected as the destination.



6. A full screen map appears with the selected point in the middle. If necessary, tap the map somewhere else to modify the destination. The Cursor () appears at the new location. Tap  to confirm the destination, or tap  to select a different destination.

7. After a short summary of the route parameters, the map appears showing the entire route. The route is automatically calculated. Tap  to modify route parameters, or tap  and start your journey.

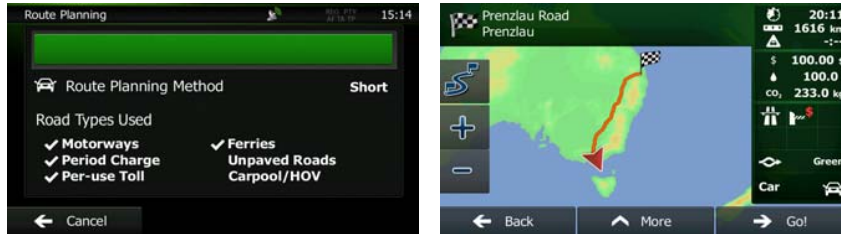

3.1.1.4 Selecting an intersection as the destination



To enter an address as the destination, do as follows:

1. If you are on the Map screen, tap  to return to the Navigation menu.

2. In the Navigation menu, tap the following buttons:



3. Select the country, state and settlement as described earlier (page 26).
4. Enter the street name:

- a. Tap .
- b. Start entering the street name on the keyboard.
- c. Find the street you need:
 - The most likely street name is always shown in the input field. To accept it, tap .
 - If the desired name does not show up, the names that match the string appear in a list after entering a couple of characters (to open the list of results before it appears automatically, tap ). Select the street from the list.



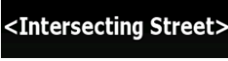

5. Enter the intersecting street name:

1. Tap .

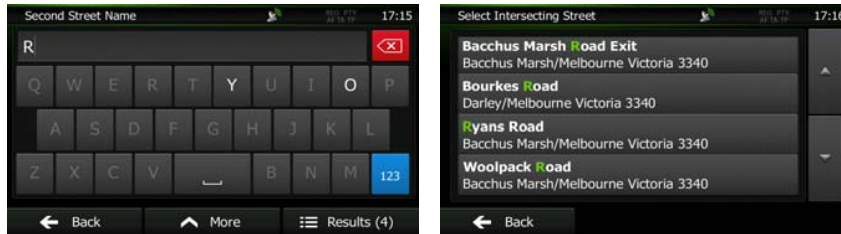
- If only a few intersecting streets exist, their list appears immediately.
- In case of a longer street, the keyboard screen appears. Start entering the name of the intersecting street on the keyboard. As soon as the street names that match the entered string can be shown on one screen, their list appears automatically. Select from the list.



6. A full screen map appears with the selected point in the middle. If necessary, tap the map somewhere else to modify the destination. The Cursor () appears at the new

location. Tap  to confirm the destination, or tap

 to select a different destination.

7. After a short summary of the route parameters, the map appears showing the entire route. The route is automatically calculated. Tap  to modify route

parameters, or tap  and start your journey.

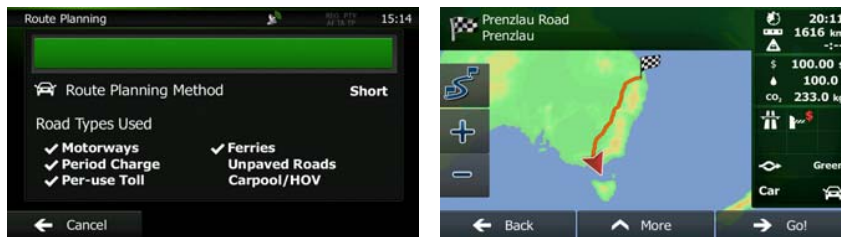

3.1.1.5 Selecting a city/town/suburb centre as the destination

The city/town/suburb centre is not the geometric centre of the settlement but an arbitrary point the map creators have chosen. In town/suburbs and villages, it is usually the most important intersection; in larger cities, it is one of the important intersections.

1. If you are on the Map screen, tap  to return to the Navigation menu.

2. In the Navigation menu, tap the following buttons:  , 

3. Select the country and state as described earlier (page 26).

4. Select the destination city/town/suburb:

a. Tap .

b. Start entering the name of the city/town/suburb on the keyboard.

c. Find the city/town/suburb you need:

- The most likely city/town/suburb name is always shown in the input field.

To accept it, tap .

- If the desired name does not show up, the names that match the string appear in a list after entering a couple of characters (to open the list of

results before it appears automatically, tap ). Select the city/town/suburb from the list.

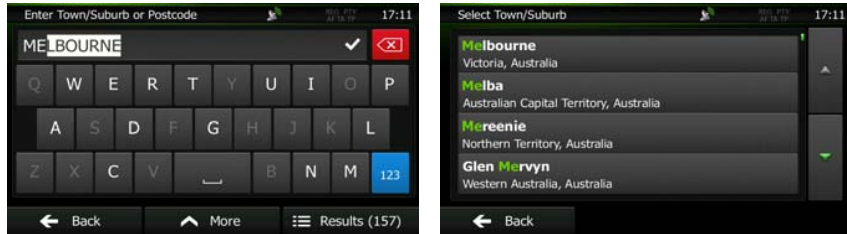

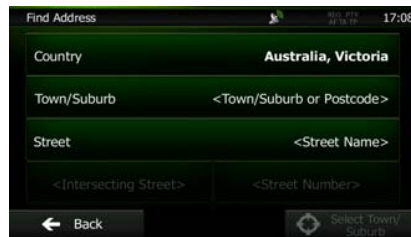

5. Instead of entering the street name, tap . This way the centre of the displayed city/town/suburb becomes the destination of the route.

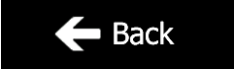

6. A full screen map appears with the selected point in the middle. If necessary, tap the map somewhere else to modify the destination. The Cursor () appears at the new

location. Tap  to confirm the destination, or tap

 to select a different destination.

7. After a short summary of the route parameters, the map appears showing the entire route. The route is automatically calculated. Tap  to modify route

parameters, or tap  and start your journey.

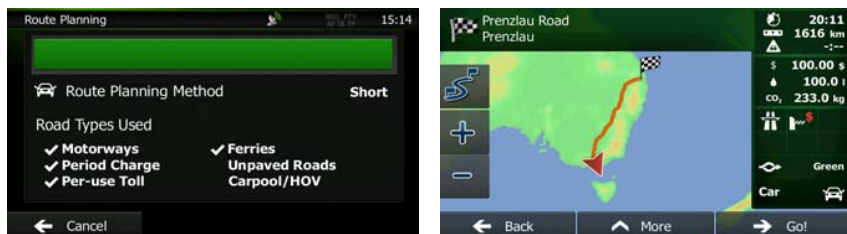

3.1.1.6 Entering an address with a postal code





All of the above address searching possibilities can be performed with entering the postal code instead of the settlement name. Find below an example with a full address:

1. If you are on the Map screen, tap  to return to the Navigation menu.

2. In the Navigation menu, tap the following buttons:  , 



3. Select the country and state as described earlier (page 26).

4. Enter a new city/town/suburb using its postal code:

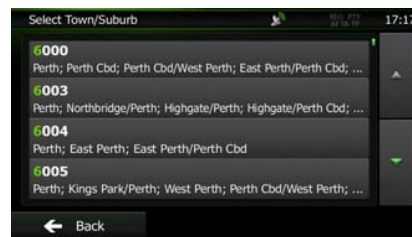
- a. Tap .
- b. Tap  to open the numeric keypad.
- c. Start entering the postal code.
- d. Find the city/town/suburb you need:
 - The most likely postal code is always shown in the input field. To accept it, tap .
 - If the desired number does not show up, open the list of results by tapping . Select the postal code from the list.

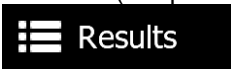

5. Enter the street name:

- a. Tap .
- b. Start entering the street name on the keyboard.
- c. Find the street you need:
 - The most likely street name is always shown in the input field. To accept it, tap .
 - If the desired name does not show up, the names that match the string appear in a list after entering a couple of characters (to open the list of results before it appears automatically, tap ). Select the street from the list.



6. Enter the house number:

- a. Tap **<House Number>**.
- b. Enter the house number on the keyboard. (To enter letters, tap **QWE**).
- c. Tap **✓ Done** to finish entering the address. (If the entered house number cannot be found, the midpoint of the street is selected as the destination.)



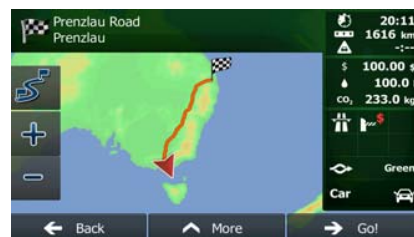

7. A full screen map appears with the selected point in the middle. If necessary, tap the map somewhere else to modify the destination. The Cursor () appears at the new location. Tap **→ Next** to confirm the destination, or tap **← Back** to select a different destination.

8. After a short summary of the route parameters, the map appears showing the entire route. The route is automatically calculated. Tap **↑ More** to modify route parameters, or tap **→ Go** and start your journey.



3.1.1.7 Tips on entering addresses quickly

- When you are entering the name of a city/town/suburb or a street:
 - Only those letters are offered on the keyboard that appear in possible search results. All other characters are greyed out.
 - As you are typing, the most likely result is always displayed in the input field. If the guess is correct, tap  to select it.
 - After entering a couple of letters, tap  to list the items that contain the specified letters.
- You can speed up finding an intersection:
 - Search first for the street with a less common or less usual name; fewer letters are enough to find it.
 - If one of the streets is shorter, search for that one first. You can then find the second one faster.
- You can search for both the type and the name of a road. If the same word appears in several names, for example in the name of streets, roads and avenues, you can obtain the result faster if you enter the first letter of the street type: For example, enter 'PI A' to obtain Pine Avenue and skip all Pine Streets and Pickwick Roads.
- You can also search in postal codes. As postal codes consist of only a few characters, this is usually faster than entering the name of the city/town/suburb.

3.1.2 Selecting the destination from the Places of Interest

You can select your destination from the Places of Interest included with Clarion Mobile Map.

Using the same screen, you can find a Place in different ways:





- with the Quick search feature, you can quickly find a nearby Place by its name
- with the Preset search feature, you can find frequently searched types of Places with only a few screen taps
- you can search for a Place by its category
- you can search for a Place by its name

In addition, you can search for special services from the 'Where Am I?' screen.

3.1.2.1 Quick search for a Place of Interest

The Quick search feature lets you quickly find a Place by its name. The search is always carried out

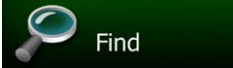
- along the recommended route if it exists or
 - around your current location if there is no destination given.
1. Start the Quick search function:

- If you are on the Map screen, tap  and then tap .
- If you are in the Navigation menu, tap ,  and then tap .



2. Using the keyboard, start entering the name of the Place.

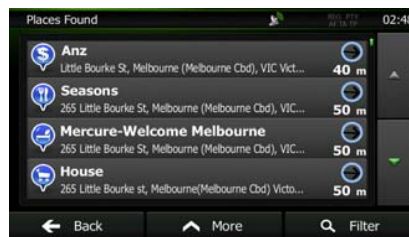

3. After entering a few letters, tap  to open the list of Places with names containing the entered character sequence.





4. (optional) The Places in the list are ordered by the length of the necessary detour (when navigating a route) or by their distance from the current position (when no destination is given). If you need to reorder the list, tap .
5. Browse the list if necessary and tap one of the list items. A full screen map appears with the selected point in the middle. The name and address of the Place is displayed at the top of the screen.

6. (optional) Tap  to see the details of the selected Place. Tap  to return to the map.

7. If necessary, tap the map somewhere else to modify the destination. The Cursor



() appears at the new location. Tap  to confirm the

destination, or tap  to select a different destination.

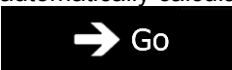

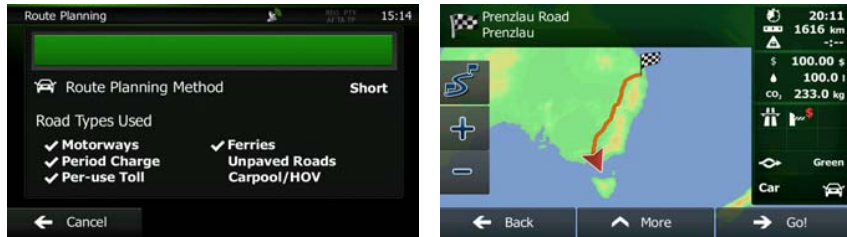
8. After a short summary of the route parameters, the map appears showing the entire route. The route is automatically calculated. Tap  to modify route parameters, or tap  and start your journey.



3.1.2.2 Searching for a Place of Interest using preset categories

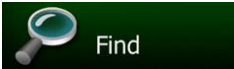

The Preset search feature lets you quickly find the most frequently selected types of Places.

1. If you are on the Map screen, tap  to return to the Navigation menu.

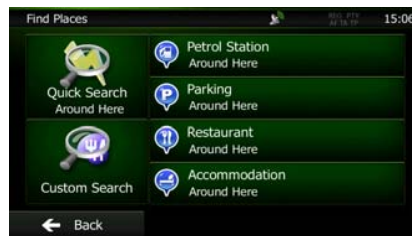
2. In the Navigation menu, tap the following buttons:  and .

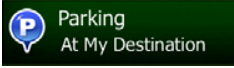

3. The preset search categories appear:

- 
 - If an active route exists, petrol stations are searched along the route.
 - If there is no active route (destination is not selected), they are searched around the current position.
 - If the current position is not available either (no GPS signal), they are searched around the last known position.
- 
 - If an active route exists, parking lots are searched around the destination of the route.
 - If there is no active route (destination is not selected), they are searched around the current position.
 - If the current position is not available either (no GPS signal), they are searched around the last known position.
- 
 - If an active route exists, restaurants are searched along the route.
 - If there is no active route (destination is not selected), they are searched around the current position.

- If the current position is not available either (no GPS signal), they are searched around the last known position.

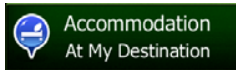

- If an active route exists, accommodation is searched around the destination of the route.
- If there is no active route (destination is not selected), they are searched around the current position.
- If the current position is not available either (no GPS signal), they are searched around the last known position.

4. Tap any of the quick search buttons to get an instant list of Places.

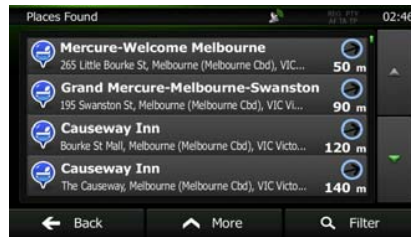

5. (optional) The Places in the list are ordered by their distance from the current or last known position, from the destination or by the length of the necessary detour. If you



need to reorder the list, tap

6. Browse the list if necessary and tap one of the list items. A full screen map appears with the selected point in the middle. The name and address of the Place is displayed at the top of the screen.



7. (optional) Tap



to see the details of the selected Place. Tap

8. If necessary, tap the map somewhere else to modify the destination. The Cursor



() appears at the new location. Tap



destination, or tap

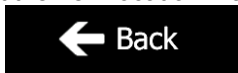

9. After a short summary of the route parameters, the map appears showing the entire

route. The route is automatically calculated. Tap



parameters, or tap

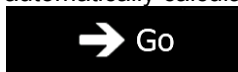

and start your journey.

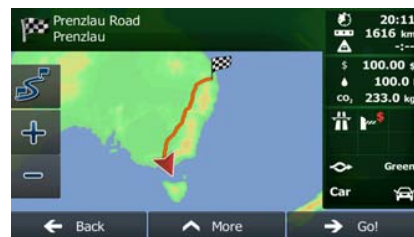

3.1.2.3 Searching for a Place of Interest by category

You can search for Places of Interest by their categories and subcategories.

1. If you are on the Map screen, tap  to return to the Navigation menu.



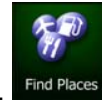
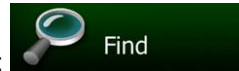

2. In the Navigation menu, tap the following buttons:

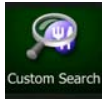

3. Tap

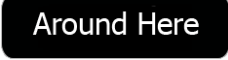

4. Select the area around which the Place should be searched for:

- Tap  to search around the current position or if it is not available, around the last known position. (The result list will be ordered by the distance from this position.)
- Tap  to search for a place within a selected city/town/suburb. (The result list will be ordered by the distance from the centre of the selected city/town/suburb.)
- Tap  to search for a place around the destination of the active route. (The result list will be ordered by the distance from the destination.)
- Tap  to search along the active route, and not around a given point. This is useful when you search for a later stopover that results in a minimal detour only, such as searching for upcoming petrol stations or restaurants. (The result list will be ordered by the length of the necessary detour.)



5. (optional) If you have selected , select the city/town/suburb to search in.



- Select one of the main Place categories (e.g. Accommodation) or tap

List All Places

to list all Places around the selected location or along the route.

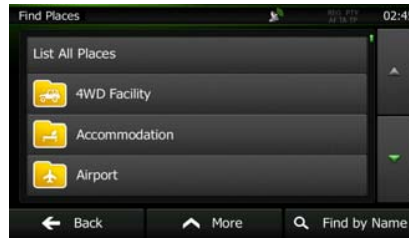

- Select one of the Place subcategories (e.g. Hotel or Motel) or tap

List All Places

to list all Places in the selected main category around the selected location or along the route.

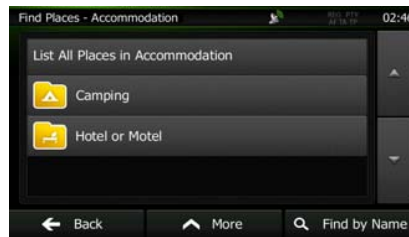

- Sometimes the list of brands in the selected Place subcategory appears. Select one

List All Places

brand or tap to list all Places in the selected subcategory around the selected location or along the route.

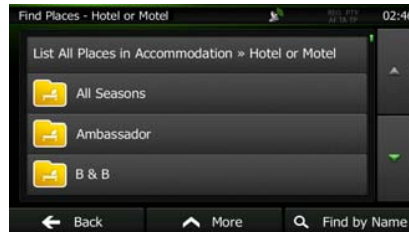

- Finally, the results appear in a list.

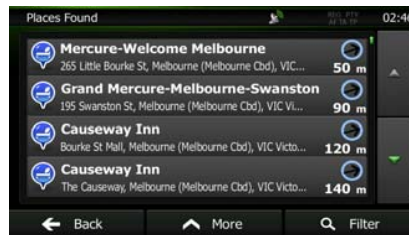







- (optional) The Places in the list are ordered by their distance from the current or last known position, from the selected city/town/suburb, from the destination or by the

length of the necessary detour. If you need to reorder the list, tap

More





- Browse the list if necessary and tap one of the list items. A full screen map appears with the selected point in the middle. The name and address of the Place is displayed at the top of the screen.

12. (optional) Tap  to see the details of the selected Place. Tap  to return to the map.
13. If necessary, tap the map somewhere else to modify the destination. The Cursor  appears at the new location. Tap  to confirm the destination, or tap  to select a different destination.
14. After a short summary of the route parameters, the map appears showing the entire route. The route is automatically calculated. Tap  to modify route parameters, or tap  and start your journey.

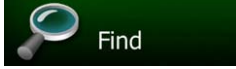

3.1.2.4 Searching for a Place of Interest by name

You can search for Places of Interest by their names. You can search around different locations or along your route in the whole Place database or in one Place category or subcategory only.

1. If you are on the Map screen, tap  to return to the Navigation menu.
2. In the Navigation menu, tap the following buttons: , 
3. Tap 
4. Select the area around which the Place should be searched for:
 - Tap  to search around the current position or if it is not available, around the last known position. (The result list will be ordered by the distance from this position.)
 - Tap  to search for a place within a selected city/town/suburb. (The result list will be ordered by the distance from the centre of the selected city/town/suburb.)
 - Tap  to search for a place around the destination of the active route. (The result list will be ordered by the distance from the destination.)

- Tap **Along Route** to search along the active route, and not around a given point. This is useful when you search for a later stopover that results in a minimal detour only, such as searching for upcoming petrol stations or restaurants. (The result list will be ordered by the length of the necessary detour.)



5. (optional) If you have selected **In a Town/Suburb**, select the city/town/suburb to search in.

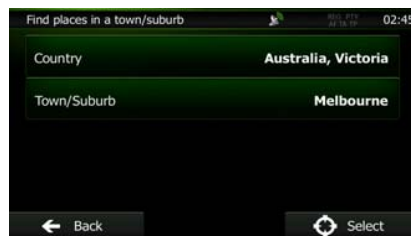

6. Select one of the main Place categories (e.g. Accommodation) to search in or tap **Find by Name** to search among all Places.

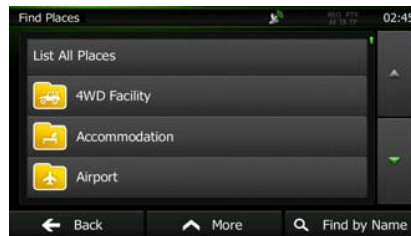

7. Select one of the Place subcategories (e.g. Hotel or Motel) to search in or tap **Find by Name** to search in the selected Place category.

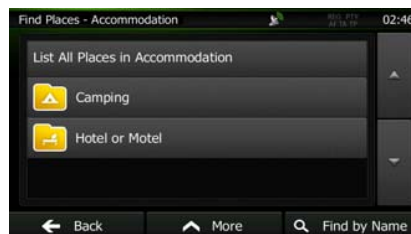

8. Tap **Find by Name** if you have not done it before.

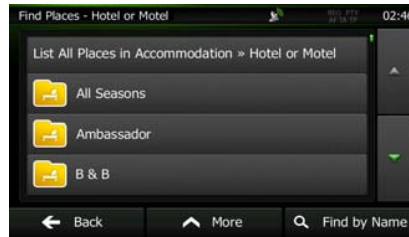

9. Using the keyboard, start entering the name of the Place.



10. After entering a few letters, tap  to open the list of Places with names containing the entered character sequence.

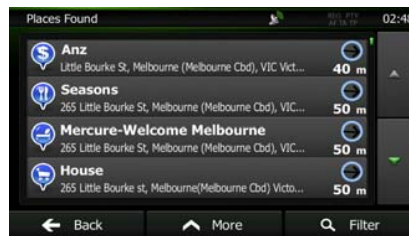



11. (optional) The Places in the list are ordered by their distance from the current or last known position, from the selected city/town/suburb, from the destination or by the

length of the necessary detour. If you need to reorder the list, tap



12. Browse the list if necessary and tap one of the list items. A full screen map appears with the selected point in the middle. The name and address of the Place is displayed at the top of the screen.



13. (optional) Tap  to see the details of the selected Place. Tap  to return to the map.

14. If necessary, tap the map somewhere else to modify the destination. The Cursor



() appears at the new location. Tap  to confirm the

destination, or tap  to select a different destination.

15. After a short summary of the route parameters, the map appears showing the entire route. The route is automatically calculated. Tap  to modify route parameters, or tap  and start your journey.

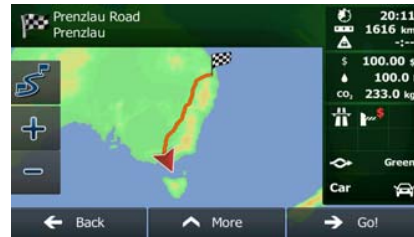
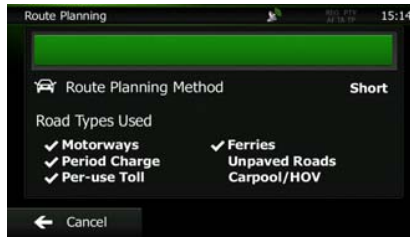

3.1.2.5 Searching for a Place of Interest by its phone number

You can search for Places of Interest by their phone number:

1. If you are on the Map screen, tap  to return to the Navigation menu.

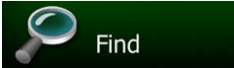
2. In the Navigation menu, tap the following buttons: ,
3. The numeric keyboard appears. Enter the phone number you are looking for or a part of it.

4. Tap .

5. The list of Places with the entered sequence in their phone number appears.

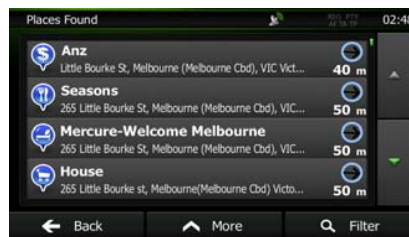

6. (optional) The Places in the list are ordered by their distance from the current or last known position, from the selected city/town/suburb, from the destination or by the

length of the necessary detour. If you need to reorder the list, tap



7. Browse the list if necessary and tap one of the list items. A full screen map appears with the selected point in the middle. The name and address of the Place is displayed at the top of the screen.

8. (optional) Tap  to see the details of the selected Place. Tap



9. If necessary, tap the map somewhere else to modify the destination. The Cursor





() appears at the new location. Tap



destination, or tap



10. After a short summary of the route parameters, the map appears showing the entire route. The route is automatically calculated. Tap  to modify route parameters, or tap  and start your journey.

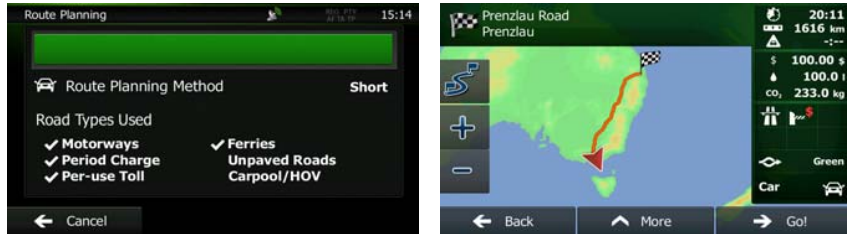

3.1.2.6 Selecting nearby assistance from 'Where Am I?'

You can quickly search for nearby assistance from the 'Where Am I?' screen.





1. On the Map screen, tap  to open the Quick menu.



2. Tap  and then .



3. Preset search categories appear, all for searching around the current position (or around the last known position if the current position is not available):

-  Car Repair Around Here : Car repair and roadside assistance services
-  Health Around Here : Medical and emergency services
-  Police Around Here : Police stations
-  Petrol Station Around Here : Petrol stations

4. Tap any of the quick search buttons to get an instant list of that type of Places.

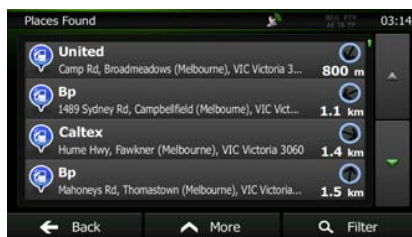

- (optional) The Places in the list are ordered by their distance from the current or last known position, from the selected city/town/suburb, from the destination or by the



length of the necessary detour. If you need to reorder the list, tap

- Browse the list if necessary and tap one of the list items. A full screen map appears with the selected point in the middle. The name and address of the Place is displayed at the top of the screen.



- (optional) Tap to see the details of the selected Place. Tap to return to the map.



- If necessary, tap the map somewhere else to modify the destination. The Cursor



() appears at the new location. Tap to confirm the



destination, or tap to select a different destination.



- After a short summary of the route parameters, the map appears showing the entire

route. The route is automatically calculated. Tap to modify route



parameters, or tap and start your journey.

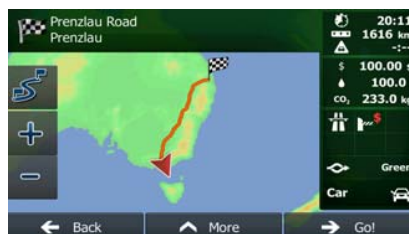
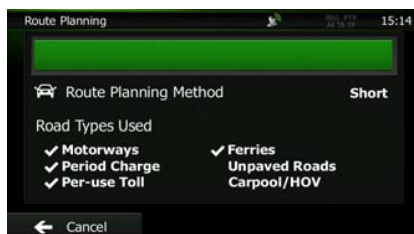

3.1.3 Selecting a map location as the destination

- If you are on the Map screen, tap to return to the Navigation menu.



- In the Navigation menu, tap the following buttons:

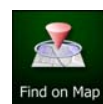
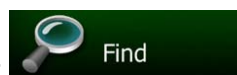



- Locate your destination on the map: move and scale the map as needed.



4. Tap the location that you want to select as your destination. The Cursor () appears.



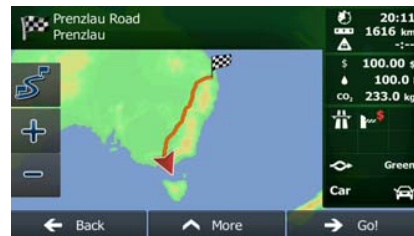

5. Tap  to select the Cursor as the destination.
6. After a short summary of the route parameters, the map appears showing the entire route. The route is automatically calculated. Tap  to modify route parameters, or tap  and start your journey.



3.1.4 Selecting the destination from your Favourites



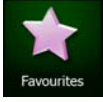
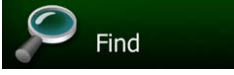

You can select a location that you have already saved as a Favourite to be your destination. Adding a location to the list of Favourite destinations is described on page 63.

1. Access the list of Favourites:

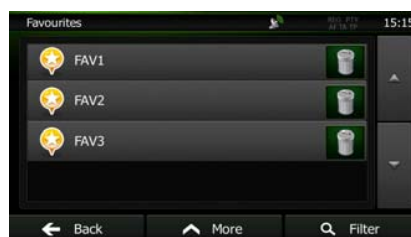
- If you are on the Map screen, tap  and then tap .
- If you are in the Navigation menu, tap  and then tap .

2. The list of Favourite destinations is displayed.

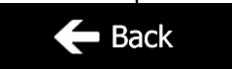

- Tap the Favourite that you want to set as your destination. If necessary, browse down to see more of the list or tap  and enter a few letters from the name of the Favourite destination.
- A full screen map appears with the selected point in the middle. If necessary, tap the map somewhere else to modify the destination. The Cursor () appears at the new location. Tap  to confirm the destination, or tap  to select a different destination.
- After a short summary of the route parameters, the map appears showing the entire route. The route is automatically calculated. Tap  to modify route parameters, or tap  and start your journey.

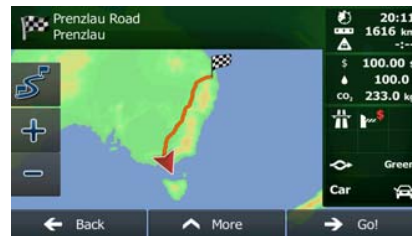
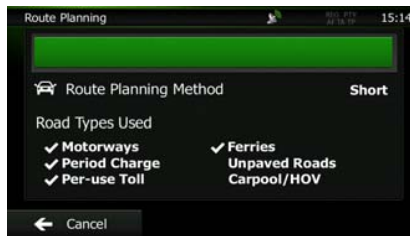

3.1.5 Selecting your Home location

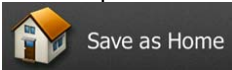
To navigate to your Home location, first you need to save it. Search for your address or browse the map and when the Cursor is at the desired location, tap  and select .

Now that the Home location is set, you can quickly navigate to it:

- To select the Home location, do one of the following:

- If you are on the Map screen, tap  and then tap  (this button can be added to the Quick menu in Settings - page 76).

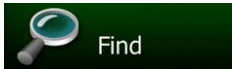

- If you are in the Navigation menu, tap  and then tap



- A full screen map appears with the selected point in the middle. If necessary, tap the map somewhere else to modify the destination. The Cursor () appears at the new location.

Tap  to confirm the destination, or tap

 to select a different destination.



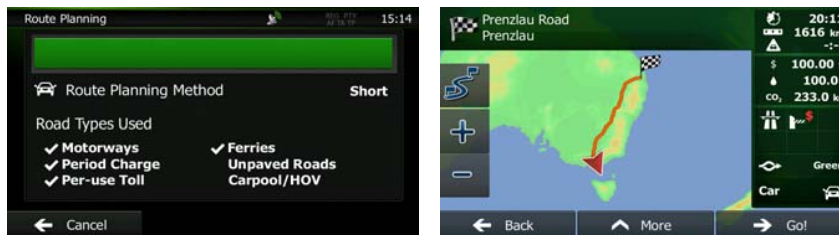

3. After a short summary of the route parameters, the map appears showing the entire route. The route is automatically calculated. Tap  to modify route parameters, or tap  and start your journey.



3.1.6 Selecting a recent destination from the History

The destinations that you have set earlier appear in the History.

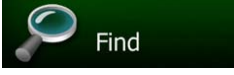
1. Access the History:

- If you are on the Map screen, tap  and then tap .
- If you are in the Navigation menu, tap  and then tap .

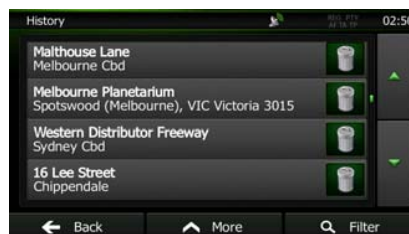

2. The list of recent destinations appears. Smart History promotes three destinations to the first page based on your previous routes (most likely destinations). The rest of the destinations are ordered by time they were last selected. If necessary, scroll the list to see earlier destinations.



3. Select a destination from the list.
4. A full screen map appears with the selected point in the middle. If necessary, tap the map somewhere else to modify the destination. The Cursor () appears at the new location.

Tap  to confirm the destination, or tap

 to select a different destination.

5. After a short summary of the route parameters, the map appears showing the entire route. The route is automatically calculated. Tap  to modify route parameters, or tap  and start your journey.

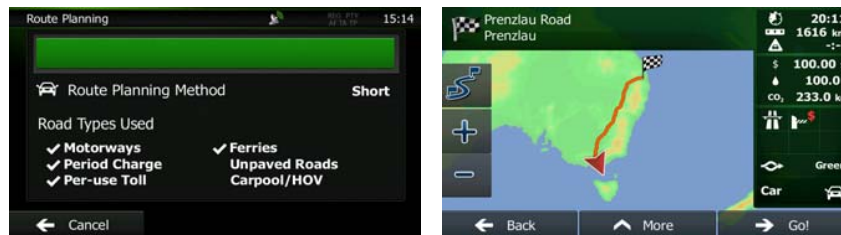

3.1.7 Entering the coordinate of the destination

You can also select a destination by entering its coordinate. Do as follows:

1. If you are on the Map screen, tap  to return to the Navigation menu.

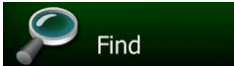
2. In the Navigation menu, tap .





3. Tap .

4. You can enter the latitude and longitude values in any of the following formats: decimal degrees; degrees and decimal minutes; or degrees, minutes and decimal seconds.

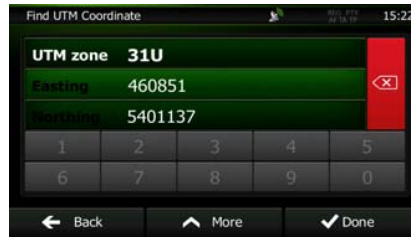

5. (optional) If necessary, tap  then  and enter the coordinate in UTM format.

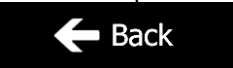



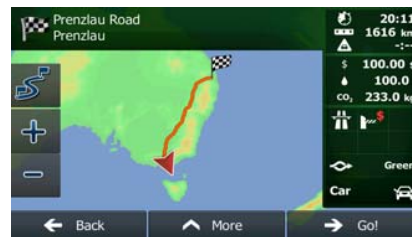
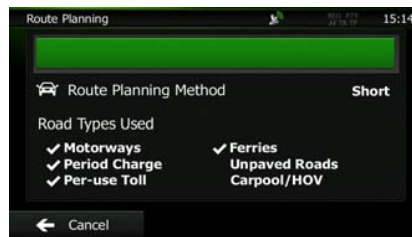

6. When finished, tap .
7. A full screen map appears with the selected point in the middle. If necessary, tap the map somewhere else to modify the destination. The Cursor () appears at the new location. Tap  to confirm the destination, or tap  to select a different destination.
8. After a short summary of the route parameters, the map appears showing the entire route. The route is automatically calculated. Tap  to modify route parameters, or tap  and start your journey.



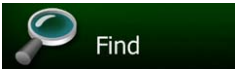

3.1.8 Navigate to a location stored in a photo

You can also set the location stored in a photo as your destination. Do as follows:

1. If you are on the Map screen, tap  to return to the Navigation menu.
2. In the Navigation menu, tap .
3. Open the  menu and tap .
4. The list of photos stored in the device appears. Select one photo from the list.
5. A full screen map appears with the selected point in the middle. If necessary, tap the map somewhere else to modify the destination. The Cursor () appears at the new location.

Tap  to confirm the destination, or tap

 to select a different destination.

6. After a short summary of the route parameters, the map appears showing the entire route. The route is automatically calculated. Tap  to modify route parameters, or tap  and start your journey.

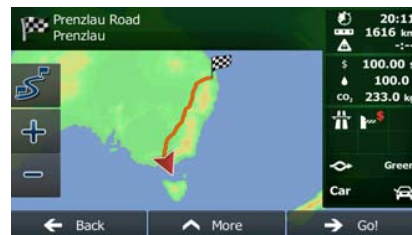

3.1.9 Building a route from the list of destinations (Create Route)

You can also build your route destination by destination from the My Route menu.

1. If you are on the Map screen, tap  to return to the Navigation menu.

2. In the Navigation menu, tap .

3. Tap .

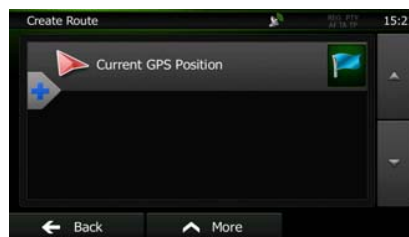

4. There is only one line in the list of route points, the start point of the route, normally the current GPS position.

5. Tap  to select the destination.

6. The Destination menu appears and you can select the destination of the route the same way as described in the previous sections.



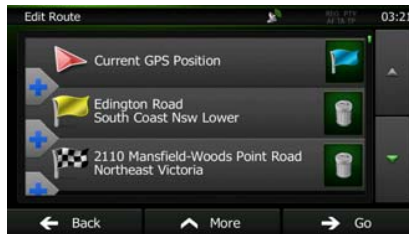

- When the new destination is selected, the list returns.



- To add more destinations, tap  where you want to insert the new route point in the list, and repeat the above procedure.

3.2 Viewing the entire route on the map

It is easy to get a map overview of the active route. Do as follows:

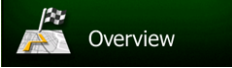
- If you are on the Map screen, tap  to return to the Navigation menu.
- In the Navigation menu, tap .
- Tap . The active route is displayed in its full length on the map together with additional information and controls.



3.3 Checking route parameters and accessing route related functions

You can check different parameters of the route recommended by Clarion Mobile Map.



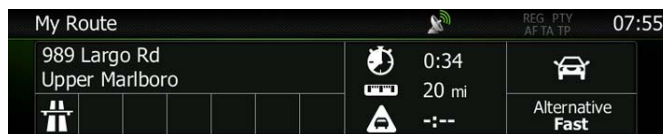

1. If you are on the Map screen, tap  to return to the Navigation menu.

2. In the Navigation menu, tap .

3. The following pieces of information are displayed:
 - The name and/or address of the destination.
 - Warning icons (if any). They provide extra information about your route (e.g. unsealed roads or toll roads to be taken).
 - The total time of the route.
 - The total length of the route.
 - Estimated delay calculated from traffic events on your route.
 - The symbol of the vehicle type used in route calculation.
 - The route planning method (e.g. Fast).

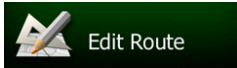
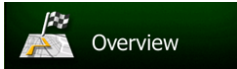

4. You have the following options on this screen (for detailed instructions on how to use them, see the next chapter):

- Tap  to edit the route: to add or remove destinations or change their sequence. You can also set a route start point other than your current location. This can be useful to plan and save a future trip.
- Tap  to display the entire route on the map.
- Tap  to bypass a part of the route.
- Tap  to delete the active route.
- Tap  to open a list with more options like selecting from route alternatives, changing route parameters, simulating the route, saving the active route or loading a previously saved route.
- Tap  to return to the Navigation menu.



3.4 Modifying the route

When navigation is already started, there are several ways to modify the active route. The following sections show some of those options.

3.4.1 Selecting a new destination when already having a route: New Route, Waypoint or Final Destination



If you already have a recommended route and you select a new destination as described in the above sections, the application will ask you whether to start a new route, add a new waypoint (intermediate destination) to the route or append the newly selected destination at the end of the current route.

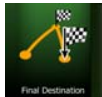

- Tap  to plan a new route to the newly selected location. The previous destination and waypoint(s) are deleted.
- Tap  to add the newly selected location as an intermediate destination to your route. The other destinations of the route remain intact. Note: the new waypoint is placed among destinations to keep the route optimal. To decide where a waypoint to appear, use the Edit Route feature.
- Tap  to append the newly selected destination at the end of the route. The other destinations of the route remain intact. The previous final destination is now the last waypoint.

3.4.2 Setting a new starting position for the route

For normal navigation, all routes are planned from the current position. In order to check future routes, simulate them or see their length in time and distance, you can turn off the GPS receiver. Then you can set the starting point of the route to a different location than the current GPS position.

1. If you are on the Map screen, tap  to return to the Navigation menu.
2. In the Navigation menu, tap .

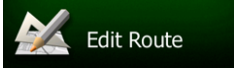
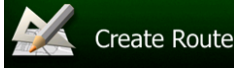
3. If you already have a route, tap . If you are starting a new route, tap .

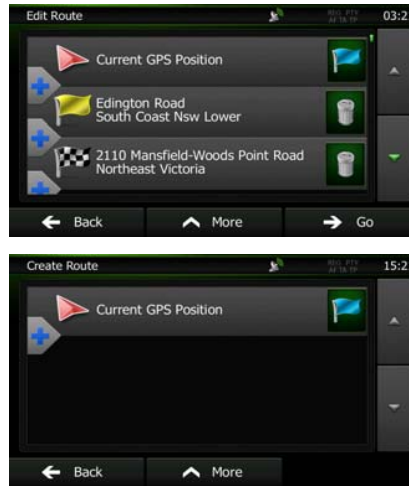

4. The first line is the start of the route, normally the current GPS position. Tap  and confirm your action at the warning message.

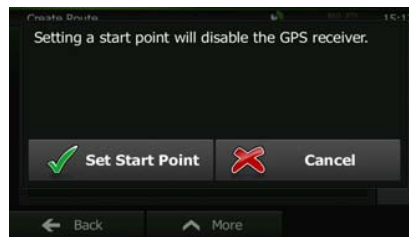

5. The Destination menu appears and you can select the start point of the route the same way you select a destination.



6. When the new start point is set, tap .
7. The map returns with a transparent Vehimarker (showing that there is no GPS reception). If an active route already existed, it is now recalculated starting from the selected location.



8. To return to normal navigation, tap

Turn on GPS

3.4.3 Editing the list of destinations (Edit Route)

You can edit the route by modifying the list of destinations. You can add or remove destinations, modify the start position or reorder the list.

1. If you are on the Map screen, tap

Menu

to return to the Navigation menu.

2. In the Navigation menu, tap



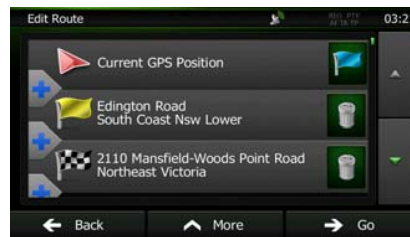
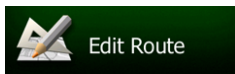

3. Tap



4. You have the following options:

- Tap  to add a new destination.

- Tap  to delete a destination.

- Tap  to modify the start point of the route.

- Tap  to reorder the list. You can do it manually or you can let the application optimise the route for you.

3.4.4 Pausing the active route

You do not need to pause the active route: when you start driving again, Clarion Mobile Map restarts the voice instructions from your position.

3.4.5 Cancelling the active route

To cancel the navigated route, do one of the following:

- If you are on the Map screen, tap  and then tap  (If you have a route with waypoints, you need to tap  until all waypoints are deleted.)
- In the Navigation menu, tap  and then tap . The active route is deleted with all its waypoints.

3.4.6 Checking route alternatives when planning the route

You can select from different route alternatives or change the route planning method after you have selected a new destination. Do as follows:

1. Select a destination as explained earlier, and get to the route confirmation screen.

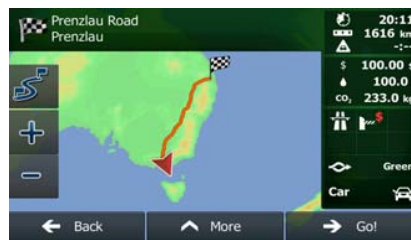

2. Tap .



3. Tap .

4. You see the basic details of three route alternatives with the selected route planning method. Tap any of them to see it on the map.



- Or if you cannot find a good alternative, tap **More Results** and scroll down for routes with different routing methods.



- Select one of the route alternatives and tap **← Back** to return to the previous screen. Clarion Mobile Map recalculates the route. The orange line now shows the new recommended route.

3.4.7 Checking route alternatives for an existing route

To recalculate the active route with a different route planning method, you can modify the Route settings (page 77). There is another way to do this and to compare different route alternatives with the same route planning method. Do as follows:

- If you are on the Map screen, tap **Menu** to return to the Navigation menu.

- In the Navigation menu, tap **My Route**.



- Tap **↑ More**.



- Tap **Route Alternatives**.
- You see the basic details of three route alternatives with the selected route planning method. Tap any of them to see it on the map.



More Results

6. Or if you cannot find a good alternative, tap **More Results** and scroll down for routes with different routing methods.



← Back

7. Select one of the route alternatives then tap and hold **← Back** for a few seconds to return to the Map screen. Clarion Mobile Map recalculates the route. The orange line now shows the new recommended route.

3.4.8 Changing the vehicle used in route planning

To recalculate the active route for a different vehicle, do as follows. These changes can also be made in Settings (page 77).

1. On the Map screen, tap  and then tap .

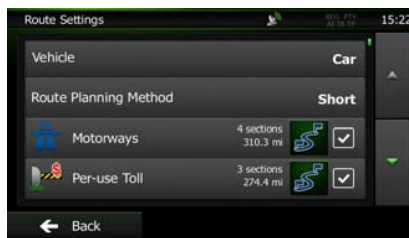

2. Tap **Vehicle** and then tap one of the following:

-  Car
-  Emergency
-  Bus
-  Taxi

- Clarion Mobile Map recalculates the route optimised for the new vehicle type. The orange line now shows the new recommended route.



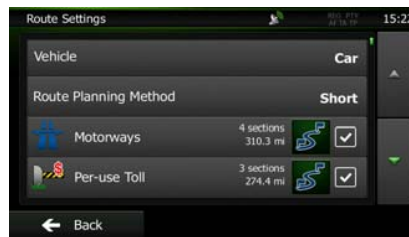

3.4.9 Changing the road types used in route planning

To recalculate the active route with different road type preferences, do as follows. These changes can also be made in Settings (page 77).

- On the Map screen, tap  and then tap .



- Tap any of the listed road types to modify the route. If needed, scroll the list for all road types. You have the following options (their order depends on the selected vehicle type):

-  Motorways - You might need to avoid motorways when you are driving a slow car or you are towing another vehicle.
-  Period Charge - Charge roads are pay roads where you can purchase a pass or vignette to use the road for a longer period of time. They can be enabled or disabled separately from toll roads.
-  Per-use Toll - Clarion Mobile Map includes toll roads (pay roads where there is a per-use charge) in the routes by default. If you disable toll roads, Clarion Mobile Map plans the best toll-free route.
-  Ferries - Clarion Mobile Map includes ferries in a planned route by default. However, a map does not necessarily contain information about the accessibility of temporary ferries. You might also need to pay a fare on ferries.
-  4WD Tracks - 4WD tracks are dirt roads in very poor condition. They can only be driven by 4WD vehicles. Clarion Mobile Map excludes 4WD tracks by default.

- Tap  to confirm the changes. Clarion Mobile Map recalculates the route. The orange line now shows the new recommended route.

3.5 Saving a location as a Favourite destination

You can add any location to Favourites, the list of frequently used destinations. Planning a route to one of the Favourite destinations is described on page 48.

1. Select a destination as described before. It can be an address, a Place, any location on the map, a previously used destination from History, a coordinate or a location where a photo was taken.
2. When the full screen map appears with the selected location in the middle, tap



3. Tap . The button is black with a pink star icon on the left and the text "Add to Favourites" in white on the right.

4. (optional) Using the keyboard, you can change the name offered for the Favourite. Tap to enter numbers or symbols.



5. Tap to save the location as a new Favourite destination. The button is black with a white checkmark icon on the left and the word "Done" in white on the right.

3.6 Saving a location as an alert point

You can save any map location as an alert point (for example a speed camera or a railway crossing).

1. Browse the map and select a location. The red Cursor appears there.

2. Tap . The button is black with a white upward-pointing arrow on the left and the word "More" in white on the right.



3. Scroll down the list and tap .
4. On the newly opened screen, select the type of the alert point, the direction from which you expect the alert, and (if applicable) the speed limit for this alert point.

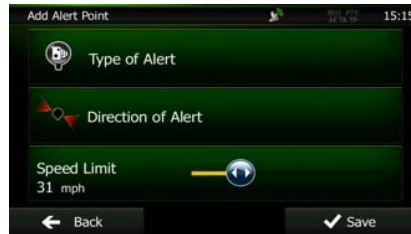

5. Tap  to save the location as a new alert point.

3.7 Editing an alert point

You can edit a previously saved or uploaded alert point (for example a speed camera or a railway crossing).

1. Browse the map and select the alert point to edit. The red circle appears around the alert point.

2. Tap .



3. Scroll down the list and tap .
4. On the newly opened screen, modify the type of the alert point, the direction from which you expect the alert, or (if applicable) the speed limit for this alert point.

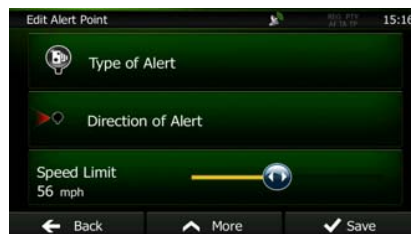

5. Tap  to save the changes to the alert point.

3.8 Watching the simulation of the route

You can run a simulated navigation that demonstrates the active route. Do as follows:

1. If you are on the Map screen, tap  to return to the Navigation menu.

2. In the Navigation menu, tap .







3. Tap .



4. Scroll down the list and tap . The simulation starts from the starting point of the route, and using a realistic speed, it leads you through the whole recommended route.



1. (optional) You have the following controls during the simulation (the control buttons disappear after a few seconds but you can open them again if you tap the map):

- : Jump to the next route event (manoeuvre).
- : Pause the simulation.
- : Jump to the previous route event (manoeuvre).
- : Tap to increase the speed of the simulation to 4, 8 or 16 times faster. Now tap again to return to the normal speed.

2. Tap  to stop the simulation.

4 Reference Guide

On the following pages you will find the description of the different concepts and menu screens of Clarion Mobile Map.

4.1 Concepts

4.1.1 Smart Zoom

Smart Zoom provides much more than just a usual automatic zoom feature:

- **While following a route:** when approaching a turn, it will zoom in and raise the view angle to let you easily recognise your manoeuvre at the next junction. If the next turn is at a distance, it will zoom out and lower the view angle to be flat so you can see the road in front of you.
- **While driving without an active route:** Smart Zoom will zoom in if you drive slowly and zoom out when you drive at high speed.

4.1.2 Daytime and night colour themes

Clarion Mobile Map uses different colour themes during the day and during the night for both the map and the menu screens.

- Daytime colours are similar to paper road maps, and the menus are bright.
- The night colour themes use dark colours for large objects to keep the average brightness of the screen low.





Clarion Mobile Map offers different daytime and night colour profiles. It can also switch automatically between the daytime and the night schemes based on the current time and GPS position a few minutes before sunrise, when the sky has already turned bright, and a few minutes after sunset, before it becomes dark.

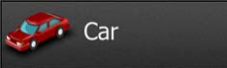

4.1.3 Route calculation and recalculation

Clarion Mobile Map calculates the route based on your preferences:

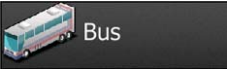
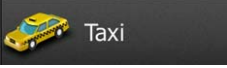
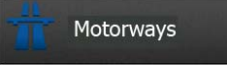
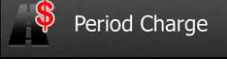
- Route planning methods:
 - **Fast**: Gives a quick route if you can travel at or near the speed limit on all roads. Usually the best selection for fast and normal cars.
 - **Short**: Gives a route that has the smallest total distance of all possible routes. It can be practical for slow vehicles.
 - **Green**: Gives a quick but fuel efficient route based on the fuel consumption data given in Green Routing settings (page 79). Travel cost and

CO₂ emission calculations are estimations only. They cannot take elevations, curves and traffic conditions into account.

-  **Easy**: Results in a route with fewer turns and no difficult manoeuvres. With this option, you can make Clarion Mobile Map to take, for example, the motorway instead of a series of smaller roads or streets.
- Vehicle types:
 -  **Car**:
 - Manoeuvre restrictions and directional constraints are taken into account when planning a route.
 - Roads are used only if access for cars is allowed.
 - Private roads and resident-only roads are used only if they are inevitable to reach the destination.
 - Walkways are excluded from routes.
 -  **Emergency**:
 - All manoeuvres are available in intersections.
 - Directional constraints are taken into account the way that opposite direction is allowed with a low speed.
 - A private road is used only if the destination is there.
 - Walkways are excluded from routes.
 -  **Bus**:
 - Manoeuvre restrictions and directional constraints are taken into account when planning a route.
 - Roads are used only if access for buses is allowed.
 - Private roads, resident-only roads and walkways are excluded from routes.
 -  **Taxi**:
 - Manoeuvre restrictions and directional constraints are taken into account when planning a route.
 - Roads are used only if access for taxis is allowed.
 - Private roads, resident-only roads and walkways are excluded from routes.
- Road types used or avoided in route calculation:
 -  **Motorways**
 -  **Period Charge**
 -  **Per-use Toll**

-  Ferries
-  Unsealed Roads
-  4WD Tracks

Real-time Traffic events are also taken into account and sometimes greatly modify the route.

Clarion Mobile Map automatically recalculates the route if you deviate from the proposed itinerary or if a newly received Traffic event concerns a part of the recommended route.

For further information about Route settings, see page 77.

4.1.4 Green routing

Route calculation is not only about finding the quickest or shortest route. For some of the vehicle types, you can also check the fuel consumption and CO₂ emission when planning a route, and you can create cost effective routes with less effect on the environment.



In Settings, select  to enter the necessary parameters of your vehicle and the average fuel price. You can also select whether you want to see the difference between your route and the green route even if the selected routing method is not Green.



After the above parameters are set, select  as route planning method to get a fast but also fuel efficient route. Note that travel cost and CO₂ emission calculations are estimations only. They cannot take elevations, turns, curves and traffic conditions into account. Also, this routing is not meant to give you the "greenest" route of all. It is still important to travel quickly so the result is a fast route with low fuel consumption and CO₂ emission.

With a vehicle type where green routing is selectable, whichever route planning method is selected, the Green details are also shown when you confirm the route:

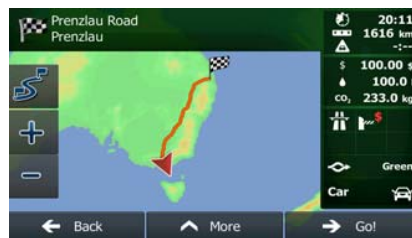

If the selected route planning method is not Green, and you have allowed the application to show the green alternative, the price, fuel consumption and CO₂ emission differences between your selected route and the Green route are also shown on this screen:

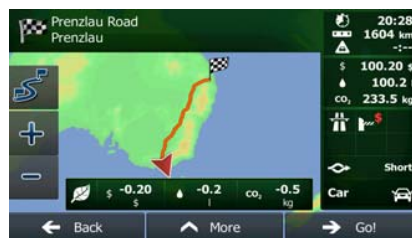

Tap the field with these details to switch the route to Green immediately.

4.1.5 Road safety cameras and other proximity alert points

There is a special proximity warning for road safety cameras (like speed or red light cameras) and other proximity alert points (like schools or railroad crossings). These alert points are preloaded in Clarion Mobile Map. You can download more from www.naviextras.com or you can upload points in a specific text file if needed.

You can also add your own alert points or edit the preloaded or uploaded points. See page 63 for details.

The application can warn you when you approach road safety cameras like speed cameras or dangerous areas like school zones or railroad crossings. You can set up the different alert types individually in Sound and Warning settings (page 75).

The following alert types are available:

- Audio warning: beeps or the spoken type of the alert can be played while you are approaching one of these points, or extra alert sounds if you exceed the given speed limit while approaching.
- Visual warning: the type of the alert point, its distance and the related speed limit appear on the Map screen while you are approaching one of these cameras. The distance from the camera is also displayed.

For some of the alert points, the enforced or expected speed limit is available. For these points, the audio alert can be different if you are below or above the given speed limit.

- Only when speeding: The audio alert is only played when you exceed the given speed limit.
- When approaching: The audio alert is always played. In order to draw your attention, the alert can be different if you exceed the speed limit.

 **Note!** The warning for road safety cameras is disabled when the GPS position is not yet available or if you are in certain countries where road safety camera warning is prohibited.

4.1.6 Speed limit warning

Maps may contain information about the speed limits of the road segments. Clarion Mobile Map is able to warn you if you exceed the current limit. This information may not be available for your region (ask your local dealer), or may not be fully correct for all roads in the map. Speed warning can be fine-tuned in Sound and Warning settings (page 75).

You can set the relative speed above which the application initiates the warning.

The following alert types are available:

- Audio warning: you receive a verbal warning when you exceed the speed limit with the given percentage.
- Visual warning: the current speed limit is shown on the map when you exceed it (for example: ).

You can also choose to see the speed limit sign on the map all the time.

4.1.7 Traffic information in route planning

The recommended route is not always the same between two points. Real-time traffic information can help you avoid current traffic events like temporary road closures or a traffic jam caused by an accident. The function is subject to data availability.

4.1.7.1 Real-time traffic information (TMC)

TMC (Traffic Message Channel) can provide you with the real-time status of the traffic. Route calculation can avoid road blocks or unexpected traffic jams caused by an accident.

TMC is a specific application of the FM Radio Data System (RDS) used for broadcasting real-time traffic and weather information.

Using traffic information is enabled by default in Clarion Mobile Map.

 **Note!** TMC is not a global service. It may not be available in your country or region. Ask your local dealer for coverage details.

NX501A contains the TMC receiver that is needed to receive Traffic events.

If public Traffic data is broadcast at your location, Clarion Mobile Map automatically takes into account the traffic events received. You do not need to set anything in the program. The receiver will automatically search the FM radio stations for TMC data, and the decoded information will immediately be used in route planning. When Clarion Mobile Map receives traffic information that may affect your route, the program will warn you that it is recalculating the route, and navigation will continue with a new route that is optimal considering the most up-to-date traffic conditions.

To fine-tune this recalculation, you can set the minimum delay that can trigger a route recalculation, or you can instruct Clarion Mobile Map to have you confirm the new recommended route before it takes effect. You can do these in Traffic settings (page 76).



A special icon () is displayed on the Map screen to show you whether traffic events are received. The icon shows the status of the traffic receiver when there are no traffic events on your route, otherwise it shows the type of the next traffic event on your route.

Road segments affected by traffic events are displayed with an alternate colour on the map, and small symbols above the road show the nature of the event:

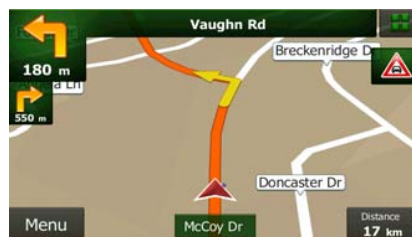

Tap  to open the Traffic Summary screen:





Tap  to open the list of traffic events:





Now tap any of the list items to see its details, and to display the affected road segment in its full length on the map:







 **Note!** If there are traffic events on the recommended route that the application has not bypassed, the  icon will open the list of significant traffic events to let you quickly check them.

4.2 'More' menu

The 'More' menu provides you with various options and additional applications. Tap the following buttons:  , .



Button	Description
	<p>You can configure the program settings, and modify the behaviour of Clarion Mobile Map. Fine-tune route planning options, change the look of the Map screen, turn on or off warnings, or restart the Configuration wizard, etc.</p> <p>See the next chapter for details.</p>
	<p>Visit www.naviextras.com to get additional content, such as new maps or 3D landmarks and useful applications.</p>
	<p>The scientific calculator helps you in all your calculation needs. Tap the Mode button for additional functions and use the memory to save your results.</p>
	<p>The Fuel consumption monitor helps you keep track of the consumption of your car even if you do not use navigation for all your journeys. Set the initial odometer value and then record the distance taken and fuel filled in whenever you fill your car. You can also set reminders for regular car maintenance.</p>
	<p>Tap this button to see the sunlit and dark areas of the world. Your current location and route points are marked on the map. Tap the Details button to see the exact sunrise and sunset times for all your route points (your current location, all waypoints and the final destination).</p>
	<p>If you save your trip logs when you arrive at some of your destinations or let the application automatically save the trip logs for you, those logs are all listed here. Tap one of the trips to see the trip statistics, speed and altitude profile. If track log has also been saved, you can display it on the map with the selected colour. Track logs can be exported to GPX files for later use.</p>
	<p>Select a country from the list and see useful driving information about the selected country. Information may include speed limits on different road types, the maximum blood alcohol level and any compulsory equipment you need to show when stopped by the police.</p>
	<p>Read the Tutorial to get instant understanding of the functions of your software.</p> <p>Run the Demo to watch sample route simulations to see how navigation works.</p> <p>The About section provides you with product information. Read the Software and Database End User License Agreement, or check the map and other contents of the application. You can also access program usage statistics.</p>





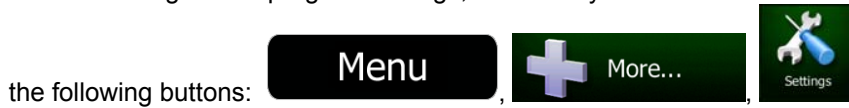



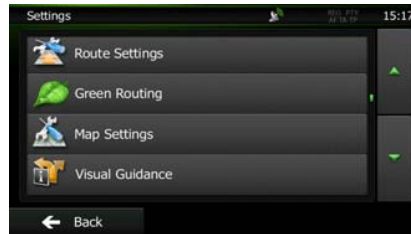

4.3 Settings menu



You can configure the program settings, and modify the behaviour of Clarion Mobile Map. Tap





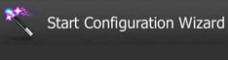

The Settings menu has several options. Tap  or scroll with your finger to see the full list.

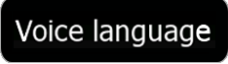

Button	Description
 Sound and Warnings	Adjust the sound volume, mute your device or change the voice guidance language. In addition, you can enable and set up different warnings and alerts.
 Customize Quick Menu	The content of the Quick menu (page 20) is fully customisable. Tap the button you want to change, and select its new function from the list.
 Traffic	The recommended route is not always the same between two points. Whenever suitable data exists, traffic information can be taken into account in the route calculation.
 Route Settings	These settings determine how routes will be calculated. Select the type of vehicle you are driving, the road types used in route planning, and the route planning method.
 Green Routing	These settings determine how Green routes will be calculated. They are also used to display the cost and CO ₂ emission of routes.
 Map Settings	You can fine-tune the appearance of the Map screen. Adjust the map view to your needs, choose suitable colour themes from the list for both daytime and night use, change the red arrow to a 3D car model, show or suppress 3D buildings, turn track logging on or off, and manage you Place visibility sets (which Places to show on the map).
 Visual Guidance	Settings related to guidance on the map screen can be adjusted here.
 Display	Display related settings.
 Regional	These settings allow you to customise the application for your local language, measurement units, time and date settings and formats, as well as to choose the time zone.
 Trip Monitor	Trip logs and track logs contain useful information about your trips. Trip logs can be saved manually when you reach your destination or you can turn on the automatic saving here.

	Modify the basic software parameters set during the initial setup process. For details, see page 7.
	Delete all saved data and reset all settings to their factory defaults.

4.3.1 Sound and Warnings

Button	Description
	Tap this button to adjust the volume of the different sounds in the application. A new screen shows the different sound types and their controls. See below for details.
	This button shows the current voice guidance profile. By tapping the button, you can select a new profile from the list of available languages and speakers. Tap any of these to hear a sample voice prompt. Just tap  when you have selected the new spoken language.
	Maps may contain information about the speed limits of the road segments. Clarion Mobile Map is able to warn you if you exceed the current limit. This information may not be available for your region (ask your local dealer), or may not be fully correct for all roads in the map. This setting lets you decide whether you wish to receive visible and/or audible warnings. Adjust the slider to set the relative speed above which the application initiates the warning. The following alert types are available: <ul style="list-style-type: none"> • Audio warning: you receive a verbal warning when you exceed the speed limit with the given percentage. • Visual warning: the current speed limit is shown on the map when you exceed it. If you prefer to see the speed limit sign on the map all the time (normally it is shown only if your speed exceeds it), you can set it here.
	This feature allows you to receive a warning when approaching a Road Safety Camera. You must ensure on your own liability that using this feature is legal in the country where you intend to use it. This button is not displayed when GPS position is not available or if you are in certain countries where road safety camera warning is prohibited. Even if the button is available, you are responsible for checking whether it is legal to use this feature at your location.

<p>Proximity Alerts</p>	<p>The application can warn you when you approach road safety cameras like speed cameras or dangerous areas like school zones or railroad crossings. Tap this button and set the different alert types individually. The following alert types are available: Audio warning: beeps or the name of the alert type can be played while you are approaching the camera, or extra alert sounds if you exceed the speed limit while approaching one of these cameras. Visual warning: the type of the alert point, its distance and the related speed limit appear on the Map screen while you are approaching one of these cameras. The distance from the camera is also displayed. For some of the alert points, the enforced or expected speed limit is available. For these points, the audio alert can be different if you are below or above the given speed limit. Only when speeding: The audio alert is only played when you exceed the given speed limit. When approaching: The audio alert is always played. In order to draw your attention, the alert can be different if you exceed the speed limit. Road safety cameras are not displayed in the list when GPS position is not available or if you are in certain countries where road safety camera warning is prohibited.</p>
<p>Warning Sign Alerts</p>	<p>Maps may contain driver alert information. Tap this button to turn on or off these warnings and to set the distance from the hazard to receive the warning at. These can be set individually for the different warning types.</p>



4.3.2 Customise Quick menu



The content of the Quick menu (page 20) is fully customisable. Tap the button you want to change, and select its new function from the list.

The list of available functions and their descriptions are on page 20.

4.3.3 Traffic settings



The recommended route is not always the same between two points. Whenever suitable data exists, traffic information can be taken into account in the route calculation.

Button	Description
 Traffic Receiver	<p>Use this switch to enable or disable the TMC receiver that can receive real-time traffic information. The rest of the buttons below are all related to the TMC function and are available only if the receiver is enabled.</p>
 Detour	<p>This setting determines how Clarion Mobile Map uses the received real-time traffic information in route calculation. When calculating a new route, or when recalculation becomes necessary based on the received Traffic events, Clarion Mobile Map avoids traffic events if it makes sense.</p> <p>You can also set the minimum delay that triggers route recalculation, and you can instruct the application if you want to confirm every recalculation.</p>

 Event Types	Tap this button to open the list of traffic event types, and select which events to take into account in route calculation.
 Provider List	Tap this button for the list of available TMC service providers.

4.3.4 Route settings





These settings determine how routes will be calculated.

Button	Description
 Vehicle	You can set the type of vehicle you will use to navigate the route. Based upon this setting, some of the road types can be excluded from the route, or some of the restrictions may not be taken into account in route calculation.
 Route Planning Method	The route calculation can be optimised for different situations and vehicle types by changing the planning method. See below for details.





To let the route fit your needs, you can also set which road types are to be considered for or to be excluded from the route if possible.

Excluding a road type is a preference. It does not necessarily mean total prohibition. If your destination can only be accessed using some of the excluded road types, they will be used but only as much as necessary. In this case a warning icon will be shown on the My Route screen, and the part of the route not matching your preference will be displayed in a different colour on the map.





In the list of road types you can see in how many segments and what total length of the road type is used in the current route.

Button	Description
 Motorways	You might need to avoid motorways when you are driving a slow car or you are towing another vehicle.
 Period Charge	Charge roads are pay roads where you can purchase a pass or vignette to use the road for a longer period of time. They can be enabled or disabled separately from toll roads.
 Per-use Toll	Clarion Mobile Map includes toll roads (pay roads where there is a per-use charge) in the routes by default. If you disable toll roads, Clarion Mobile Map plans the best toll-free route.
 Ferries	Clarion Mobile Map includes ferries in a planned route by default. However, a map does not necessarily contain information about the accessibility of temporary ferries. You might also need to pay a fare on ferries.
 4WD Tracks	4WD tracks are dirt roads in very poor condition. They can only be driven by 4WD vehicles. Clarion Mobile Map excludes 4WD tracks by default.

Vehicle types:







-  Car:
 - Manoeuvre restrictions and directional constraints are taken into account when planning a route.
 - Roads are used only if access for cars is allowed.
 - Private roads and resident-only roads are used only they are inevitable to reach the destination.
 - Walkways are excluded from routes.
-  Emergency:
 - All manoeuvres are available in intersections.
 - Directional constraints are taken into account the way that opposite direction is allowed with a low speed.
 - A private road is used only if the destination is there.
 - Walkways are excluded from routes.
-  Bus:
 - Manoeuvre restrictions and directional constraints are taken into account when planning a route.
 - Roads are used only if access for buses is allowed.
 - Private roads, resident-only roads and walkways are excluded from routes.
-  Taxi:
 - Manoeuvre restrictions and directional constraints are taken into account when planning a route.
 - Roads are used only if access for taxis is allowed.
 - Private roads, resident-only roads and walkways are excluded from routes.

Route Planning Method types:

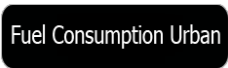
Button	Description
	Gives a quick route if you can travel at or near the speed limit on all roads. Usually the best selection for fast and normal cars.
	Gives a short route to minimise the distance to travel. It can be practical for slow vehicles. Searching for a short route regardless of the speed, this route type is rarely practical for normal vehicles.
	Gives a quick but fuel efficient route based on the fuel consumption data given in Green Routing settings (page 79). Travel cost and CO ₂ emission calculations are estimations only. They cannot take elevations, curves and traffic conditions into account.
	Results in a route with fewer turns and no difficult manoeuvres. With this option, you can make Clarion Mobile Map to take, for example, the motorway instead of a series of smaller roads or streets.

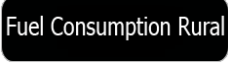
4.3.5 Green routing settings

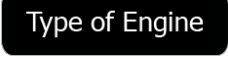
These settings determine how Green routes will be calculated. They are also used to display the cost and CO₂ emission of routes.

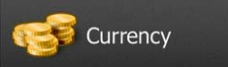
Button	Description
	Enter the average consumption of your vehicle when used in built-up areas. If necessary, tap  and select  to change the measurement unit.
	Enter the average consumption of your vehicle when used on highways. If necessary, tap  and select  to change the measurement unit.
	Select the engine and fuel type of your vehicle. This helps in estimating the CO ₂ emission.
	Enter the average fuel price for travel cost calculation. If necessary, tap  and select  to change the currency.









<p>Calculate Green Alternative</p>	<p>If the selected routing method is not Green, you can have your route compared to the best green alternative on the screen when confirming the route. If this alternative is much better than the selected method, you can quickly switch to Green mode.</p>
---	--



4.3.6 Map settings

You can fine-tune the appearance of the Map screen. Adjust the map view to your needs, choose suitable colour themes from the list for both daytime and night use, change the red arrow to a 3D car model, show or hide 3D buildings, turn track logging on or off, and manage you Place visibility sets (which Places to show on the map).

The map is always shown on the screen so that you can see the effect when you change a setting.







Button	Description
	<p>Switch the map view between a 3D perspective view and a 2D top-down view.</p>
	<p>Adjust the basic zoom and tilt levels to your needs. Three levels are available.</p>
	<p>Switch between daytime and night colour modes or let the software switch between the two modes automatically a few minutes before sunrise and a few minutes after sunset.</p>
	<p>Select the colour scheme used in daytime mode.</p>
	<p>Select the colour scheme used in night mode.</p>
	<p>Replace the default position marker to one of the 3D vehicle models. You can select separate icons for different vehicle types selected for route planning. Separate icons can be used for car, pedestrian and the other vehicles.</p>
	<p>Show or suppress 3D landmarks, 3D artistic or block representations of prominent or well-known objects.</p>
	<p>Show or suppress 3D city models, 3D artistic or block representation of full city building data containing actual building size and position on the map.</p>

	<p>Turn on or off track log saving, that is, saving the sequence of the locations your journeys go through.</p>
	<p>Select which Places to show on the map while navigating. Too many Places make the map crowded so it is a good idea too keep as few of them on the map as possible. For this, you have the possibility to save different Place visibility sets. You have the following possibilities:</p> <ul style="list-style-type: none"> • Tap the checkbox to show or hide the Place category. • Tap the name of the Place category to open the list of its subcategories. • Tap  to save the current Place visibility set or to load a previously saved one. Here you can also revert to the default visibility settings.

4.3.7 Visual guidance settings

Settings related to guidance on the map screen can be adjusted here.

	<p>The data fields in the corner of the Map screen can be customised. Tap this button and select the values you want to see. The values can be different when you navigate a route from when you are just cruising without a given destination. You can select general trip data like your current speed or the altitude, or route data related to your final destination or the next waypoint on your route.</p>
	<p>Whenever adequate information is available, lane information similar to the real ones on road signs above the road is displayed at the top of the map. You can turn this feature on or off.</p>
	<p>If you are approaching a motorway exit or a complex intersection and the needed information exists, the map is replaced with a 3D view of the junction. You can turn this feature on or let the map be displayed for the whole route.</p>
	<p>Turn on the route progress bar to see your route as a straight line on the left side of the map. The red arrow represents your current position and moves up as you travel. Waypoints and Traffic events are also displayed on the line.</p>

4.3.8 Display settings

Display related settings include menu animations, separate skins for daytime and night use and the brightness of the display.

	<p>When animation is turned on, buttons on menus and keyboard screens appear in an animated way. Screen transitions are also animated.</p>
---	--

4.3.9 Regional settings

These settings allow you to customise the application for your local language, measurement units, time and date settings and formats, as well as to choose the time zone.

Button	Description
Program language	This button displays the current written language of the user interface. By tapping the button, you can select a new language from the list of available languages. The application will restart if you change this setting; you are asked to confirm this.
Units and Formats	You can set the distance units to be used by the program. Clarion Mobile Map may not support all the listed units in some voice guidance languages. Select between 12 and 24 hours time display and the various international date display formats.
Time Zone	By default, time zone is taken from the map information and adjusted by your current location. Here you can set time zone and daylight saving manually.

4.3.10 Trip monitor settings

Trip logs contain useful information about your trips. Trip logs can be saved manually when you reach your destination or you can turn on the automatic saving here. You can access these logs in the Trip monitor. Trip monitor is available from the More menu.

Enable auto-saving	Trip monitor can record statistical data of your trips. If you need these logs later, you can let the application save them automatically for you.
Trip database size	This is not a button. This line shows the current size of the trip database, the sum of all trip and track logs saved.
Save track log	Track logs, the sequence of the positions given by the GPS receiver, can be saved together with trip logs. They can later be displayed on the map. You can let the application save the track log whenever it saves a trip.

5 Glossary

2D/3D GPS reception

The GPS receiver uses satellite signals to calculate its (your) position and needs at least four signals to give a three-dimensional position, including elevation. Because the satellites are moving and because objects can block the signals, your GPS device might not receive four signals. If three satellites are available, the receiver can calculate the horizontal GPS position but the accuracy is lower and the GPS device does not give you elevation data: only 2D reception is possible.

Active route

The currently navigated route. Whenever the destination is set, the route is active until you delete it, reach your destination or you quit Clarion Mobile Map. See also: Route.

City Centre

The city/town/suburb centre is not the geometric centre of the settlement but an arbitrary point the map creators have chosen. In town/suburbs and villages, it is usually the most important intersection; in larger cities, it is one of the important intersections.

Colour theme

Clarion Mobile Map comes with different colour themes for daytime or night use of the map and menu screens. Themes are custom graphic settings and they can have different colours for streets, blocks or surface waters in 2D and 3D modes, and they display shades or shadows in different ways in 3D mode.

One daytime scheme and one night scheme is always selected for the map and for the menus. Clarion Mobile Map uses them when it switches from day to night and back.

GPS accuracy

Several factors have impact on the deviation between your real position and the one given by the GPS device. For example, signal delay in the ionosphere or reflecting objects near the GPS device have a different and varying impact on how accurately the GPS device can calculate your position.

Map

Clarion Mobile Map works with digital maps which are not simply the computerised versions of traditional paper maps. Similarly to the paper road maps, the 2D mode of digital maps show you streets, roads, and elevation is also shown by colours.

In 3D mode, you can see the altitude differences, for example valleys and mountains, elevated roads, and in selected cities 3D landmarks and 3D buildings are also displayed.

You can use digital maps interactively: you can zoom in and out (increase or decrease the scale), you can tilt them up and down, and rotate them left and right. In GPS-supported navigation, digital maps facilitate route planning.

Road Safety Camera

Special alert points for speed, red light or bus lane cameras. Different data sources are available. You can configure Clarion Mobile Map to warn you when you approach one of these cameras.

Detecting the location of Road Safety Cameras is prohibited in certain countries. It is the sole responsibility of the driver to check whether this feature can be used during the trip.

The software is capable of showing and warning for more than just cameras. Various other types of proximity alert points like school zones and railway crossings are also available.

Route

A sequence of route events, i.e. manoeuvres (for example, turns and roundabouts) to reach the destination. The route contains one start point and one or more destinations. The start point is the current (or last known) position by default. If you need to see a future route, the start point can be replaced with any other given point.

Track-up map orientation

In Track-up mode the map is rotated so its top always points in the current driving direction. This is the default orientation in 3D map view mode.

Vehimarker

The current position is shown with a red arrow on the map by default. The direction of the red arrow shows the current heading. This position marker can be replaced with different vehicle and pedestrian symbols. You can even specify different Vehimarkers for different route types (depending on which vehicle type is selected for route calculation).

6 End User Licence Agreement

1 The contracting parties

1.1 This Agreement has been entered into by and between NNG Kft. (registered seat: 23 Bérc utca, H-1016 Budapest, Hungary; Company reg.no.: 01-09-891838) as Licensor (hereinafter: Licensor) and You as the User (hereinafter: User; the User and the Licensor jointly referred to as: Parties) in subject of the use of the software product specified in this Agreement.

2 Conclusion of the Agreement

2.1 The Parties hereby acknowledge that this Agreement shall be concluded by implicit conduct of the Parties without signing the Agreement,

2.2 The User hereby acknowledges that following the lawful acquisition of the software product constituting the object of this Agreement (Section 4), any degree of use, installation into a computer or other hardware, installation of such hardware into a vehicle, pressing of the "Accept" button displayed by the software during installation or use (hereinafter referred to as Use) shall mean that the User has accepted the terms and conditions of this Agreement as legally binding.

2.3 This Agreement shall by no means authorise use of the software product by those persons having unlawfully acquired the software product or having unlawfully installed it on a computer or in a vehicle.

3 Relevant laws and regulations

3.1 Any action related to this Agreement will be governed by the laws of the Republic of Hungary, with specific reference to Act IV of 1959 on the Civil Code and to Act LXXVI of 1999 on Copyrights shall apply.

3.2 The original language version of this Agreement is the Hungarian version. This Agreement has versions in other languages as well. In case of dispute the Hungarian version shall prevail.

4 Object of the Agreement and Termination

4.1 The object of this Agreement shall be the navigation guidance software product of Licensor (hereinafter referred to as the Software Product).

4.2 The Software Product shall include the operating computer program, its complete documentation, the map database pertaining thereto and any third-party content and services accessible through the Software Product (hereinafter: Database).

4.3 Any form of display, storage, coding, including printed, electronic or graphic display, storage, source or object code, or any other as yet undefined form of display, storage, or coding, or any medium thereof shall be deemed parts of the Software Product.

4.4 Error corrections, additions, updates used by the User following the conclusion of this Agreement shall also be deemed parts of the Software Product.

4.5 Your rights under this Agreement will terminate immediately without notice from Licensor if you materially breach it or take any action in derogation of Licensor's and/or its licensors' rights to the Software Product. Licensor may terminate this Agreement should any Software Product become, or in Licensor's reasonable opinion likely to become, the subject of a claim of intellectual property infringement or trade secret misappropriation. Upon termination, you will cease use of, and destroy Software Product and confirm compliance in writing to Licensor

5 Rights under copyright

5.1 Unless otherwise provided by law or contractual provisions, the Licensor is the sole and exclusive owner of all material copyrights vested in the Software Product.

5.2 Copyrights extend to the whole Software Product and to its parts separately as well.

5.3 The owner(s) of the copyrights of the Database forming part of the Software Product is (are) the natural person(s) or corporate entity(ies) listed in the Appendix to this Agreement or in the "About" menu item of the operating computer programme (hereinafter referred to as Database Owner). The user's manual of the Software Product includes the name of the menu option where all the owners of the Database items are listed. The Licensor hereby states that it has obtained sufficient usage and representation rights from the Database owners in order

to utilise the Database, to offer it for utilisation and to transfer it for utilisation as set forth in this Agreement.

5.4 Pursuant to this Agreement, all rights vested in the Software Product shall remain in the ownership of the Licensor, except for those to which the User is entitled under law or by virtue of this Agreement.

6 Rights of the User

6.1 The User is entitled to install the Software Product into one hardware device (desktop, handheld, portable computer, navigation device), and to run and use one copy of the Software Product or a preinstalled copy of the Software Product thereon.

6.2 The User is entitled to make one backup copy of the Software Product. However, if the Software Product operates after installation without the use of the original media copy, then the original media copy shall be deemed to be a backup copy. In all other cases, the User is only entitled to use the backup copy if the original media copy of the Software Product has been ascertainably and unequivocally rendered unsuitable for its lawful and intended use.

7 Limitations of use

7.1 The User is not entitled

7.1.1 to duplicate the Software Product (to make a copy thereof);

7.1.2 to lease, rent or lend it or to transfer it to a third person for any reason;

7.1.3 to translate the Software Product (including translation (compilation) to other programming languages);

7.1.4 to decompile the Software Product;

7.1.5 to evade the protection of the Software Product or to modify, circumvent or obviate such protection through technological or by any other means;

7.1.6 to modify, extend, transform the Software Product (in whole or in part), to separate it into parts, combine it with other products, install it in other products, utilise it in other products, not even for the purpose of achieving interoperability with other devices;

7.1.7 apart from using the computer program, to obtain information from the Database as a part of the Software Product, to decompile the Database, to use, copy, modify, extend, transform the Database in whole or in part or the group of data stored therein, or to install it in other products or otherwise, utilise it in other products or to transfer it, not even with the aim of achieving interoperability with other products.

7.2 The User may only use the contents available through the Software Product and provided by third parties and the data received through the services provided by third parties (including but not limited to the traffic data received from the RDS TMC traffic information service) for his/her own personal benefit and at his/her own risk. It is strictly prohibited to store, to transfer or to distribute these data or contents or to disclose them in full or in part to the public in any format or to download them from the product.

8 No warranty, limitation of liability

8.1 The Licensor hereby informs the User that although the greatest care was taken in producing the Software Product, given the nature of the Software Product and its technical limitations, the Licensor does not provide a warranty for the Software Product being completely error-free, and the Licensor is not bound by any contractual obligation whereby the Software Product obtained by the User should be completely error-free.

8.2 The Licensor does not warrant that the Software Product is suitable for any purpose defined either by the Licensor or the User, and does not warrant that the Software Product is capable of interoperating with any other system, device or product (e.g. software or hardware).

8.3 The Licensor does not assume any responsibility for damages incurred due to an error in the Software Product (including errors of the computer program, the documentation and the Database).

8.4 The Licensor does not assume any responsibility for damages incurred due to the Software Product not being applicable for any defined purpose, or due to the error or

incompatibility of the Software Product with any other system, device or product (e.g. software or hardware).

8.5 The Licensor also draws the attention of the User to the fact that, when using the Software Product in any form of vehicle, observing the traffic regulations and rules (e.g. use of obligatory and/or reasonable and suitable security measures, proper and generally expected care and attention in the given situation, and special care and attention required due to the use of the Software Product) is the exclusive responsibility of the User. The Licensor shall not assume any responsibility for any damages occurred in relation to use of the Software Product in a motor vehicle.

8.6 By concluding the Agreement, the User shall, in particular, acknowledge the information stated in Section 8 above.

9 Sanctions

9.1 The Licensor hereby informs the User that, if the Licensor finds its rights under the Copyright Act to be breached, the Licensor may

9.1.1 seek judicial recognition of this breach;

9.1.2 demand that the breach cease and order the person in breach to refrain from continuing such actions;

9.1.3 demand that the person under breach give proper compensation (even by way of publicity at the expense of the person in breach);

9.1.4 claim the return of the increase of assets due to the breach;

9.1.5 demand the cease of the wrongful action and, demand restitution to its state before the breach was committed at the expense of the person in breach, and may demand the destruction of instruments and materials used to commit the breach as well as of the products created by the breach;

9.1.6 claim for damages.

9.2 The Licensor hereby also informs the User that the breach of copyrights and related rights is a crime under Act IV of 1978 on the Hungarian Criminal Code, which may be sentenced of two years in prison in basic cases and up to eight years in prison in aggravated cases.

9.3 Contents and services provided by third parties

The Licensor hereby excludes any liability of its own for the Database in the Software Product and for any content or service provided by a third party by using the Database. The Licensor does not warrant the quality, suitability, accuracy, fitness for a specific purpose or territorial coverage of the product or service or the availability of the service, and it specifically excludes any liability for the suspension of the service, and any damage arising in relation to the service or for complete cancellation of the service.

The relevant information and data in connection with the contents and services provided by third parties are available at www.naviextras.com. The User hereby acknowledges that the contents and services provided by third parties may only be used at the risk of the User and for the personal benefit of the User.

9.4 Contents and services provided by the Licensor or an agent of the Licensor

The Licensor or a contractual partner may offer various products and services to the User through www.naviextras.com. The User may only use these services when the User has read and understood the relevant end user license agreement(s) at www.naviextras.com and the User is obliged to use the services in line with the terms and conditions thereof.

9.5 The parties hereby agree that the courts of the Republic of Hungary will have exclusive jurisdiction to rule on any disputes arising in connection with this Agreement.

10. Anonymous data collection

10.1 The User hereby acknowledges that the Software Product may collect and store data connected to the usage of the Software Product by the User (e.g. movement/route data, user interaction data). Such data collection functions may be disabled or enabled by User any time from within the corresponding menu. The collected data is connected to the device type

identifier of the device running the Software Product and not associated in any way with any personal information of the User or with the User itself.

10.2 The collected data may be uploaded to Licensor's database and used exclusively for the purpose of enhancing and improving the features and services of the Software Product and the Databases. Uploading is executed through Licensor's special software or by the User navigation device, and the upload may be enabled or disabled by User. After successful data upload, the collected data is deleted from the Software Product storage media.

10.3 Collected data is transmitted, stored and handled anonymously and no connection of the data with the User shall be established by Licensor or any third party.

7 Copyright note

The product and the information contained herein are subject to change without prior notification.

This manual may not, in whole or in part, be reproduced or transmitted in any form either electronically or mechanically, including photocopying and recording, without the express written consent of Clarion.

© 2011 - Clarion

© 2010 NAVTEQ. All rights reserved.

All rights reserved.

8. SUNA Licence Agreement

By activating, using and/or accessing the SUNA Traffic Channel, SUNA Predictive or other content or material provided by Intelematics (together, SUNA Products and/or Services), you must accept certain terms and conditions. The following is a brief summary of the terms and conditions that apply to you. To view the full terms and conditions relevant to your use of the SUNA Products and/or Services, please consult www.sunatraffic.com.au/termsandconditions/ .

1. Acceptance

By using SUNA Products and/or Services, you will be deemed to have accepted and agreed to be bound by the terms and conditions fully detailed at www.sunatraffic.com.au/termsandconditions/ .

2. Intellectual Property

SUNA Products and/or Services are for your personal use. You may not record, or retransmit the content, nor use the content in association with any other traffic information or route guidance service or device not approved by Intelematics. You obtain no right of ownership in any Intellectual Property Rights (including copyright) in the data that is used to provide SUNA Products and/or Services.

3. Appropriate Use

SUNA Products and/or Services are intended as an aid to personal motoring, and do not provide comprehensive or accurate information on all occasions. On occasions, you may experience additional delay as a result of using SUNA Products and/or Services. You acknowledge that it is not intended, or suitable, for use in applications where time of arrival or driving directions may impact the safety of the public or yourself.

4. Use of SUNA Products and Services while driving

You, and other authorised drivers of the vehicle in which SUNA Products and/or Services are installed and active, remain at all times responsible for observing all relevant laws and codes of safe driving. In particular, you agree to only actively operate SUNA Products and/or Services when the Vehicle is at a complete stop and it is safe to do so.

5. Service Continuity and Reception of the SUNA Traffic Channel

We will use reasonable endeavours to provide the SUNA Traffic Channel 24 hours a day, 365 days a year. The SUNA Traffic Channel may occasionally be unavailable for technical reasons or for planned maintenance. We will try to perform maintenance at times when congestion is light. We reserve the right to withdraw SUNA Products and/or Services at any time.

Also, we cannot assure the uninterrupted reception of the SUNA Traffic Channel RDS-TMC signal at any particular location.

6. Limitation of Liability

Neither Intelematics (nor its suppliers or the manufacturer of your device (the "Suppliers")) shall be liable to you or to any third party for any damages either direct, indirect, incidental, consequential or otherwise arising out of the use of or inability to use SUNA Products and/or Services even if Intelematics or a Supplier has been advised of the possibility of such damages. You also acknowledge that the neither Intelematics nor any Supplier guarantees nor make any warranties that relate to the availability, accuracy or completeness of SUNA Products and/or Services, and to the extent which it is lawful to do so, both Intelematics and each Supplier excludes any warranties which might otherwise be implied by any State or Federal legislation in relation to SUNA Products and/or Services. .

7. Please Note

Great care has been taken in preparing this manual. Constant product development may mean that some information is not entirely up-to-date. The information in this document is subject to change without notice.

9. Naviextras (Map Update Process)

Note: This process may change in time and is included as a reference only.

1 How to Start Using Naviextras?

Naviextras is a portal providing maps and other updates for Clarion navigation devices.

If you have not used Naviextras before, you will need to create an account. Start by clicking **Create a user profile** in the 'Login' window on the start page: <http://clarion.naviextras.com/>.

The screenshot shows the Naviextras website interface. At the top, there is a navigation bar with links for MAIN, SITE TOUR, MAPS & MORE, DOWNLOADS, SUPPORT, and FORUM. A language dropdown menu is set to English. The main content area is divided into several sections:

- LOGIN:** A form with fields for Username and Password, a 'Remember me' checkbox, and a 'LOGIN' button. Below the form are links for 'Create a user profile' and 'Forgot username or password?'.
- Update your maps now to the latest maps!** A large promotional banner with a 'MAP UPDATES' button.
- SEARCH:** A search bar with a 'CATALOG' button.
- DID YOU KNOW ...:** A section with two paragraphs of text and a 'Click here to browse the map updates!' link.
- MY DEVICE:** A section titled 'Contents will be locked to this device:' featuring 'Clarion NX700E' and a 'DOWNLOAD SYNCTOOL' button. Below it, it states 'Purchase is limited to devices that were connected to Naviextras Toolbox.' and a 'CHANGE DEVICE MODEL' button.
- PREPAID CARD OR CODE:** A section with a small Naviextras logo.
- MOST RECOMMENDED:** A section for 'Eastern Europe - TopMap Edition' with a description of the package and a list of included countries.
- BEST OFFERS:** A section for '3D pack - Western Europe' with a price of 14.95 EUR (crossed out from 19.95 EUR) and a 'READ MORE' button. Below it is a 'Map of Europe' offer.
- NEWS:** A section with two news items: '2010 Q4 NNG maps of Eastern Europe are released' and '2010 Q4 TA map of Brazilia is released'.

On the **REGISTRATION** page, enter all required information to create a Naviextras account.

After filling in the form, you will soon receive an e-mail to verify the validity of your e-mail address. Activate your account by clicking on the first link in the e-mail.

After validating your account, the final step is **device registration**. Specify your navigation system by choosing your device from the roll-down menu, then click **REGISTER**.

naviextras.com
updates for **clarion**

MAIN SITE TOUR MAPS & MORE DOWNLOADS SUPPORT FORUM LANGUAGE: English

LOGIN

Username

Password

Remember me

[LOGIN](#)

[Create a user profile](#)

[Forgot username or password?](#)

DEVICE REGISTRATION

Specify your navigation system

Some site features, including buying updates, require registration of your navigation device or software. Please select your navigation system type from the list below.

Clarion

[DELETE DEVICE](#) [REGISTER](#)

SUPPORTED DEVICES

This is the official update site for the following devices:

Clarion, Clarion Truck

Please visit back regularly for the latest compatibility list as we are constantly adding support for new devices.

[SUPPORTED DEVICES](#)

ABOUT NAVIEXTRAS

Naviextras.com is the official map update portal for a growing number of personal navigation devices and PDA navigation software.

[Click here to see the current list of compatible devices.](#)

[TAKE THE TOUR](#)

[REGISTER NOW!](#)

Register your maps with Naviextras Toolbox



A free PC-tool called Naviextras Toolbox is available on the [Downloads](#) page. Once you connect your navigation device to your PC and launch this tool, it will automatically scan your device for installed software and maps. Alternatively Naviextras Toolbox also might recognize SD cards that were removed from the navigation device and put into a card reader.

[GO TO DOWNLOAD PAGE](#)

To be able to update the contents of your device, you will need the following:

- A **PC with Internet connection**
- A **microSD card reader** connected to your PC
- The **Naviextras Toolbox PC-tool** to download updates (downloadable from clarion.naviextras.com)

2 How to install Naviextras Toolbox?

Before downloading the installer from the Downloads page, please make sure that your PC meets minimum technical requirements specified on the download page (operating system, enough free space on your local hard disk).

Installation of Naviextras Toolbox is quick and easy.

First, downloading the installer file from <https://clarion.naviextras.com/shop/portal/downloads>. After that, simply double-click the file to start the installation.

During the installation process follow the instructions on the screen and click Next:



Naviextras Toolbox will then begin to install onto your PC.

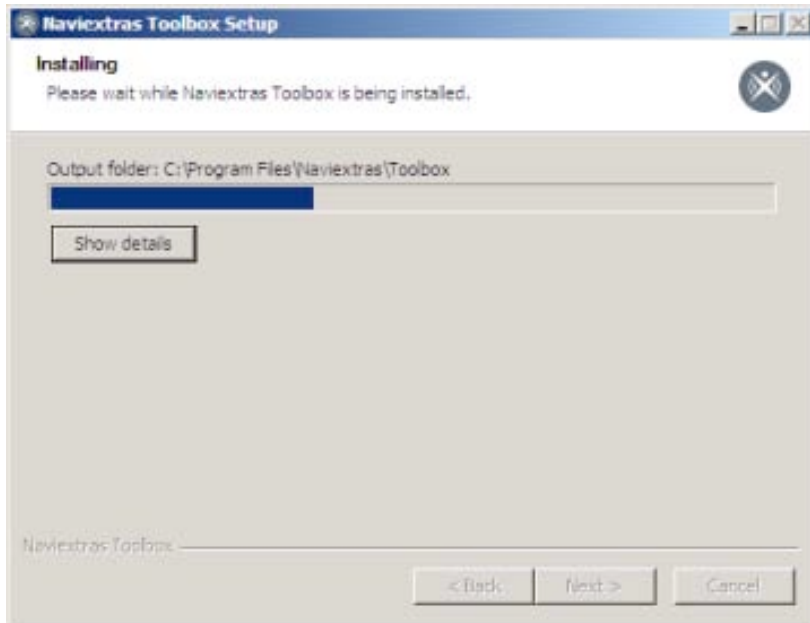

Please be patient while the Naviextras Toolbox is installed.



If you checked the "I would like to start Toolbox now." option, Toolbox will start automatically after installation.

Toolbox has an Auto Update feature, which prompts you to upgrade it at every startup if there is a newer version available. If you choose to upgrade, you will go through the same installation procedure again as described above.

Please note that you must have administrator privileges on your computer to be able to update the software. If you are notified about an update without the possibility of performing it, please contact your network administrator.

For advanced users or network administrators, it is also possible to download Naviextras Toolbox and install it silently from the command line. To do that, type 'Toolbox_Setup.exe /S'.

3 How to start using Naviextras Toolbox? (Connecting navigation device and logging in)

This Guide explains the very first steps of using Toolbox: how to connect your navigation device to your PC and how to log in with your username and password.

After Toolbox has been started, you will see the main page. The toolbar on the top of the page informs you that no device is connected:

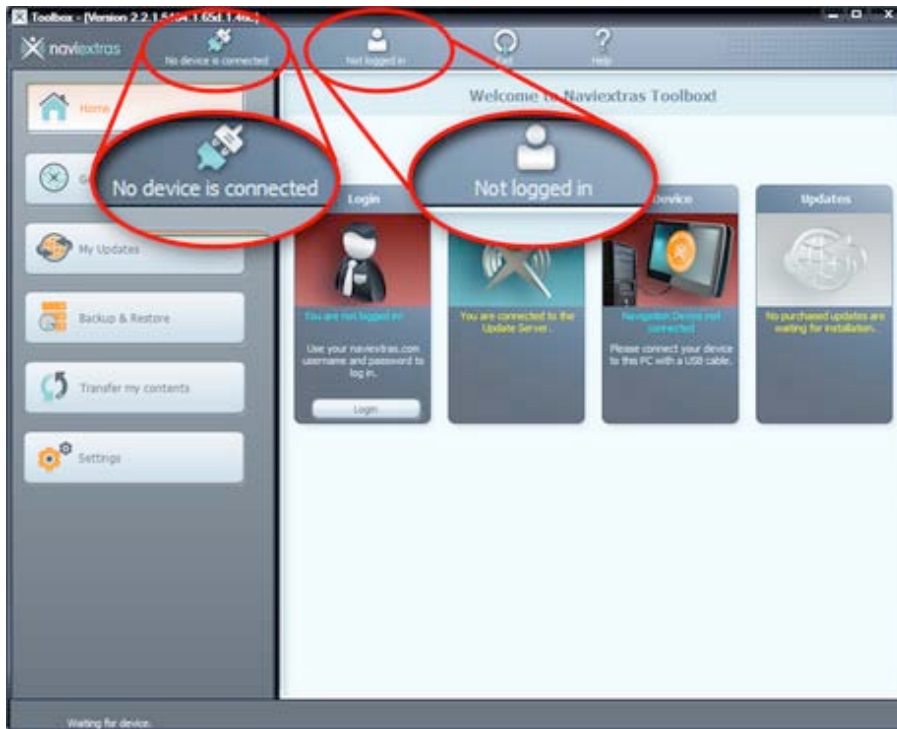

So the initial steps are:

1. Connect your navigation device to your PC.
2. Make sure your PC is connected to the internet.
3. Click the 'Not logged in' icon or the Login button to log in with your username and password.

Let's see them one by one:

1. Connect your navigation device to your PC.

Insert the microSD card that contains the navigation software into a card reader connected to your PC.

When Toolbox finds your device in the list of supported devices, the device name will appear on the top of Toolbox window.

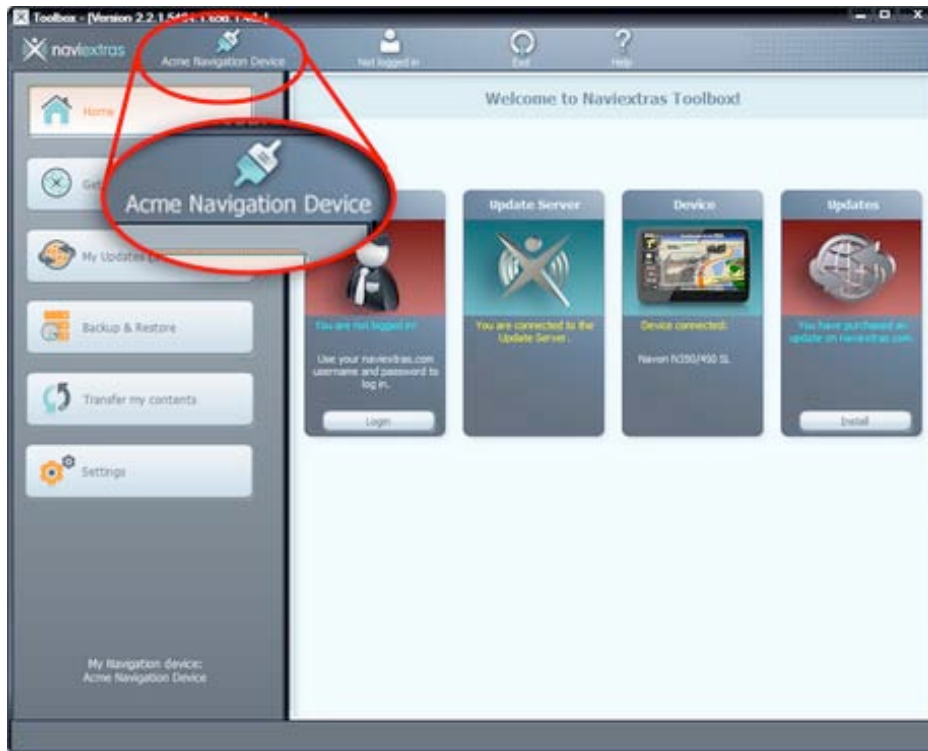

Some navigation devices are capable of collecting strictly anonymous usage statistics and GPS logs. These logs can be used by the developers to improve the quality of maps and the navigation software. If your device can collect such information, Toolbox will ask you to allow the upload of that information for anonymous processing. Click the "Do not display this in the future" checkbox if you do not want to be asked again. (You can change your decision any time later in Settings.)

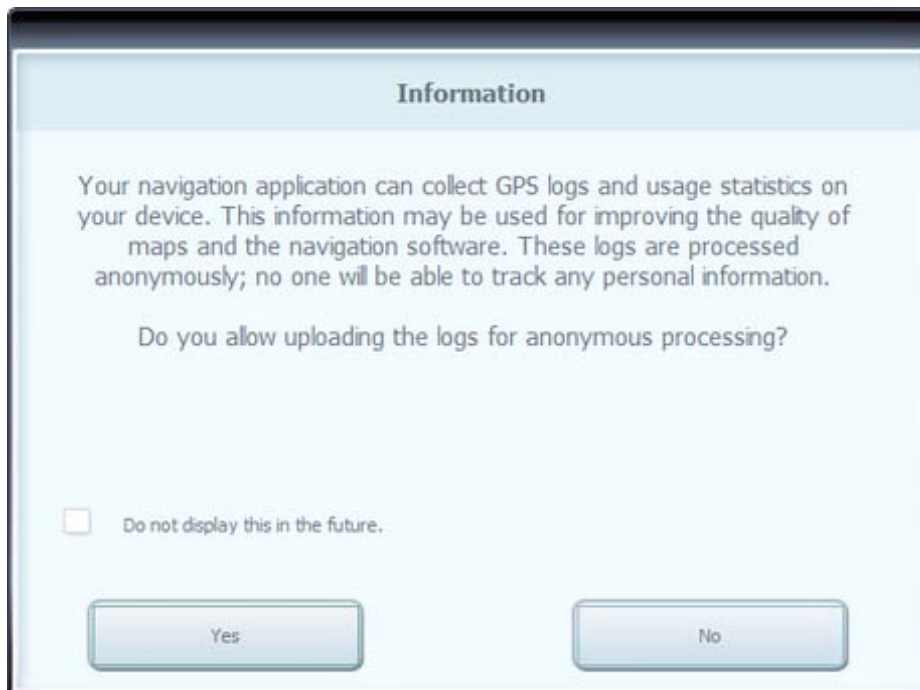

2. Make sure your PC is connected to the Internet.

Internet connection is required for Toolbox to verify if any update is available for download, and of course later to download it.

3. Click the 'Not logged in' icon or the Login button to log in with your username and

password

Toolbox and the Naviextras site work in an integrated way. When you buy an update or any extra map on the Naviextras web site, and then you log in to Toolbox, it will immediately know that you have the right to download and license it. Also, if you are entitled to have a free update, this will be shown in Toolbox after you log in.

To log in, click the 'Not logged in' icon in the toolbar at the top of the page or click the Login button in the 'Login' frame in the center of the Toolbox main screen.

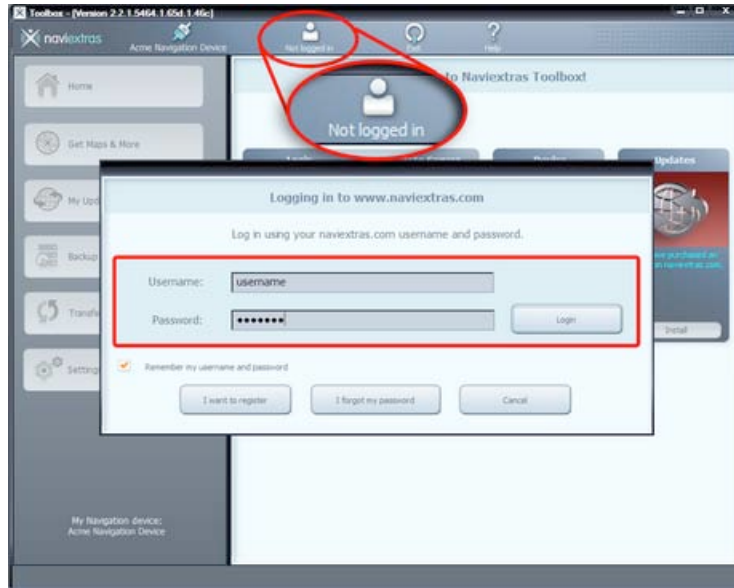

When you have successfully logged in, your username will be shown on the top of all Toolbox screens.

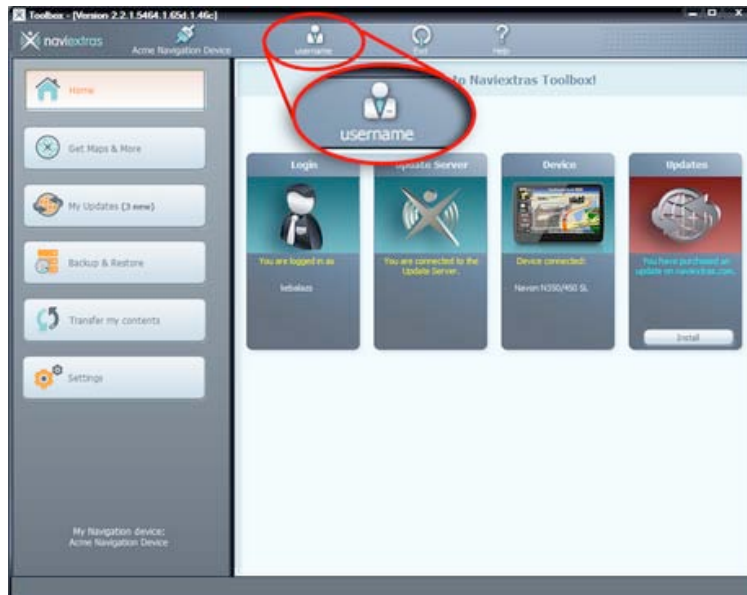

After you have successfully connected your device and logged in, your device is already identified and registered into your Naviextras user profile.

If you previously added your device type on Naviextras site to your user profile, it is now overwritten by the automatic registration of Toolbox.

4 How to browse and select updates in Toolbox?

If you already purchased update(s) on the Naviextras portal, you can skip these steps and continue with reading the **How to download and install updates? Guide**.

After successfully connecting your device and logging in, you can start browsing updates and extra maps in Toolbox. Click on the **Get Maps & More** button in the menu bar on the left hand side.

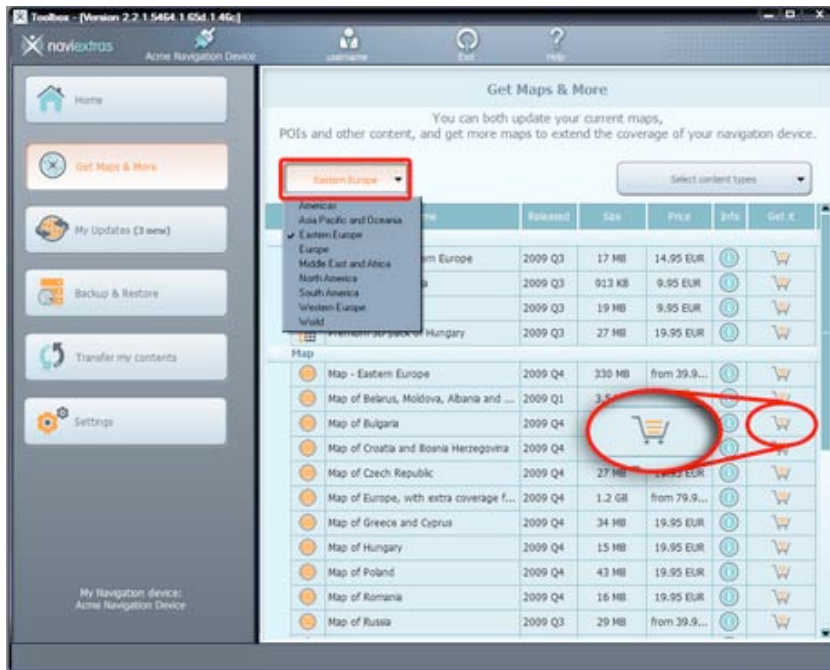

Available updates and extras can be filtered by geographic region or content type (map, 3D landmark, 3D package, etc.) with the two roll-down menus above the list of available updates. If some content is available for you after payment, the price and a shopping cart icon is shown for that item. If an update is available for you free of charge, an icon of a 'free' price tag is shown instead of the price. You can find out more details about the updates by clicking on the blue (i) icon.

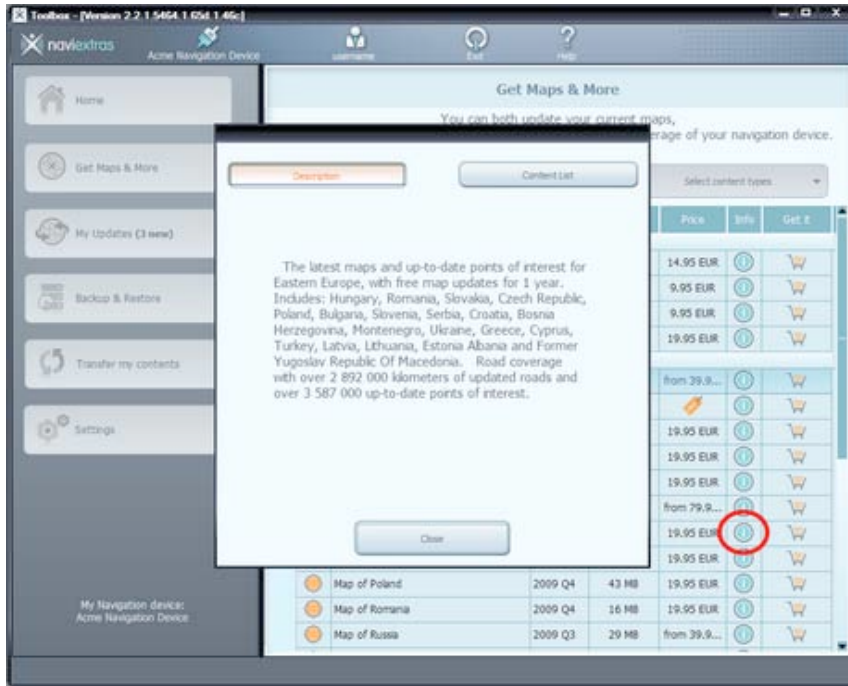

After you have purchased an update or added a free item to your cart, it is added to the installation queue, and the number of updates awaiting installation is shown on the **My Updates** button.

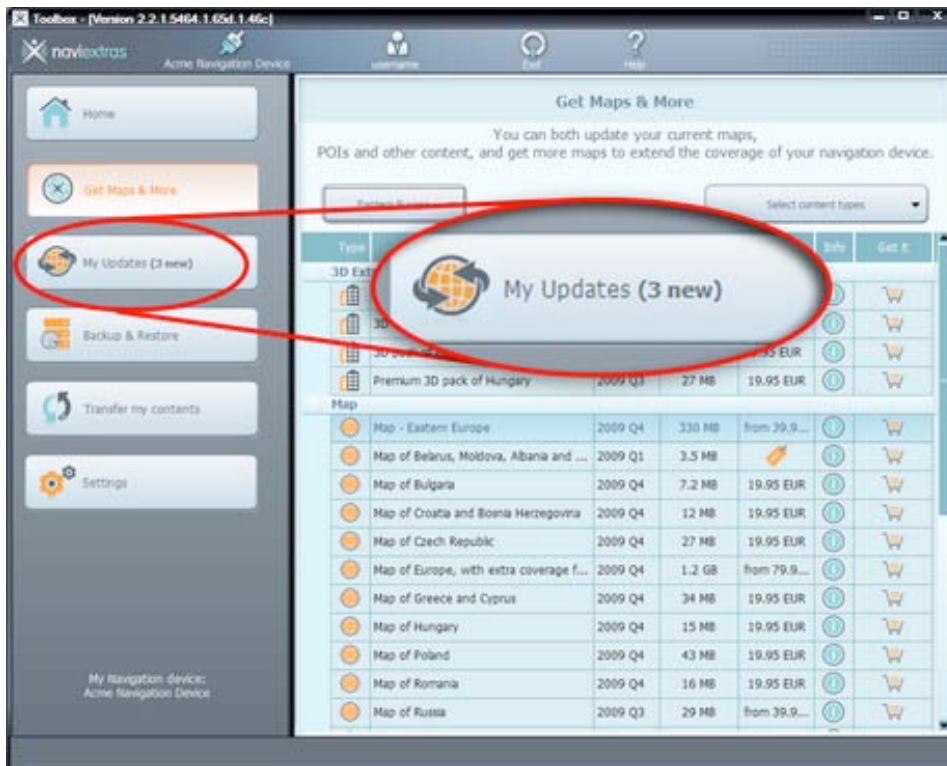

Click the **My Updates** button to continue with the download and installation of updates.

5 How to buy updates and extras in Toolbox (instead of buying them on the Naviextras web site)?

Instead of buying updates and extras on the Naviextras site, you can decide to buy them conveniently in Toolbox. This Guide explains the simple Toolbox purchase and checkout procedure.

Buying updates and extras is very similar to buying on the Naviextras site, so this Guide will mainly explain the few differences.

You can start buying by clicking on the shopping cart icon next to the selected item.

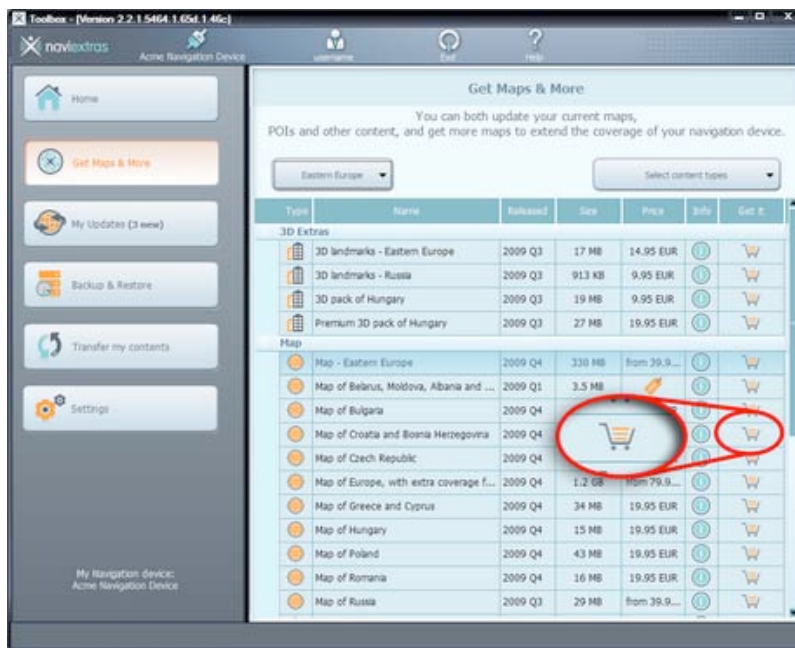

It will open a new Toolbox window with a web-site like page with the detailed description of that item. You can add it to the cart by clicking on the **Add to cart** icon, just the same way as on the portal.

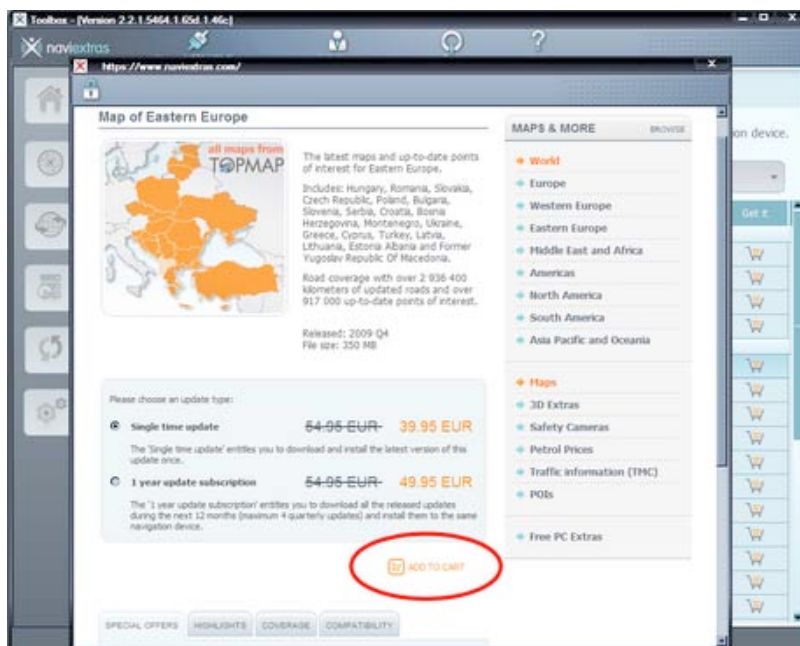

After adding the item to the cart, you will see your cart with a button to start the checkout process.

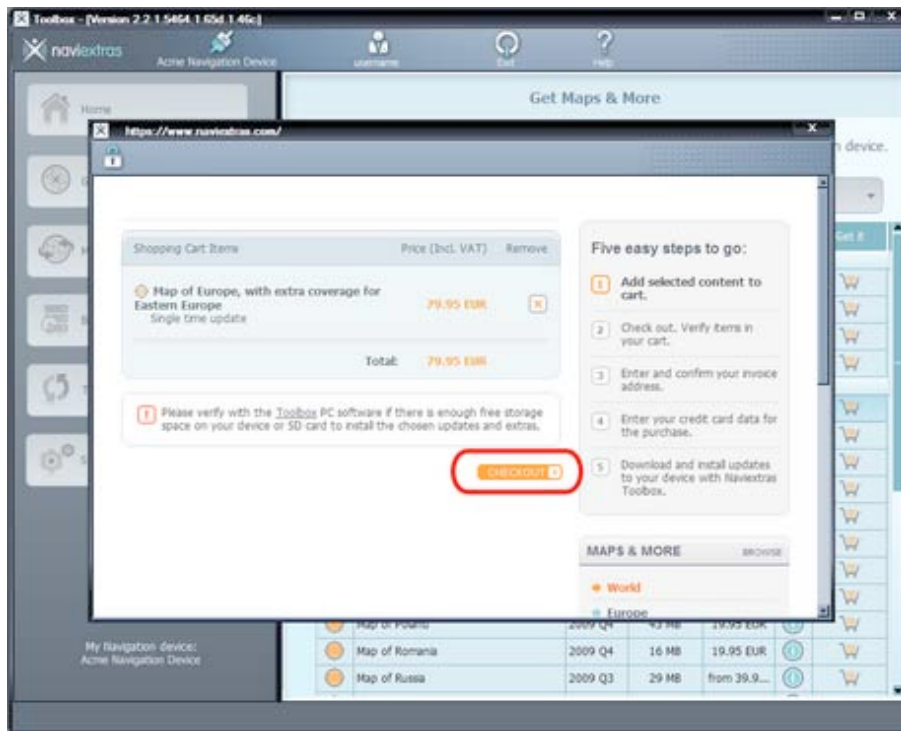

If you would like to buy additional updates too, simply close this window and click the shopping cart icon for another item, then click the **Add to cart** button to add the next item to your cart.

When all items are in the cart, click on the **Checkout** button and go through the same checkout process as on the Navixtras site.

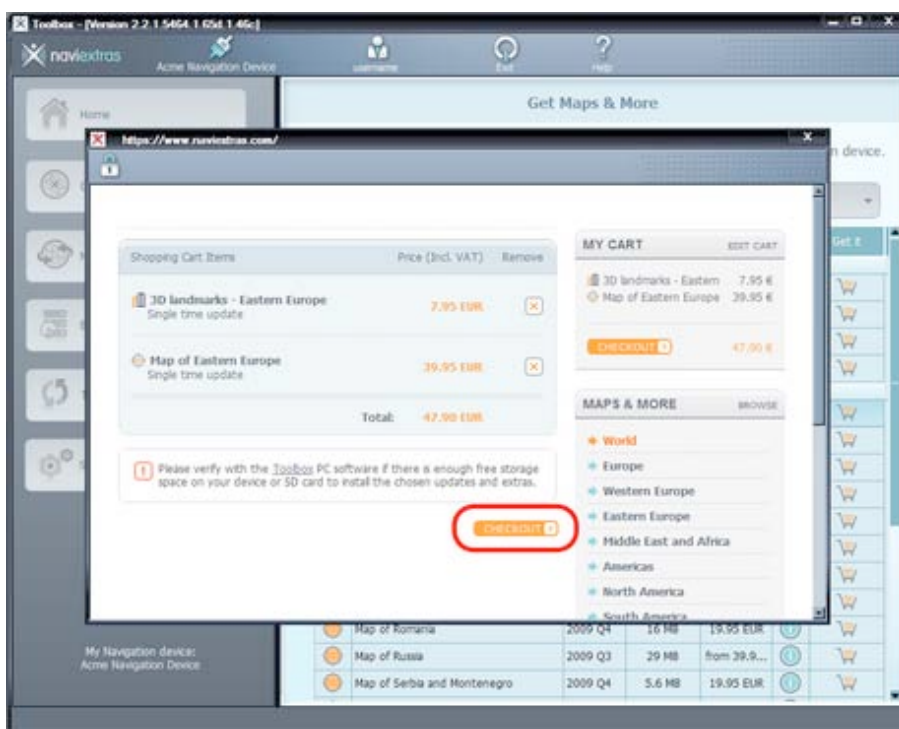

6 How to download and install updates to the navigation system?

If you purchased pay update(s) and/or added free updates to the installation queue, please click on the **My Updates** button in the menu bar on the left hand side. This is the last step to update your navigation system.

The My Updates screen shows you the list of:

- purchased items (updates or extras),
- free updates and extras added to the installation queue from the Get Maps & More screen,
- and special free updates (which are normally pay updates but your manufacturer or the Site operator provides them to you free of charge).

Installable contents are always displayed at the top of the list. For items you have just purchased, it might take a few seconds to appear. Please wait until you can see them as well.

You can install content items by clicking the **Install** button above the content list. This will start the Installation wizard.

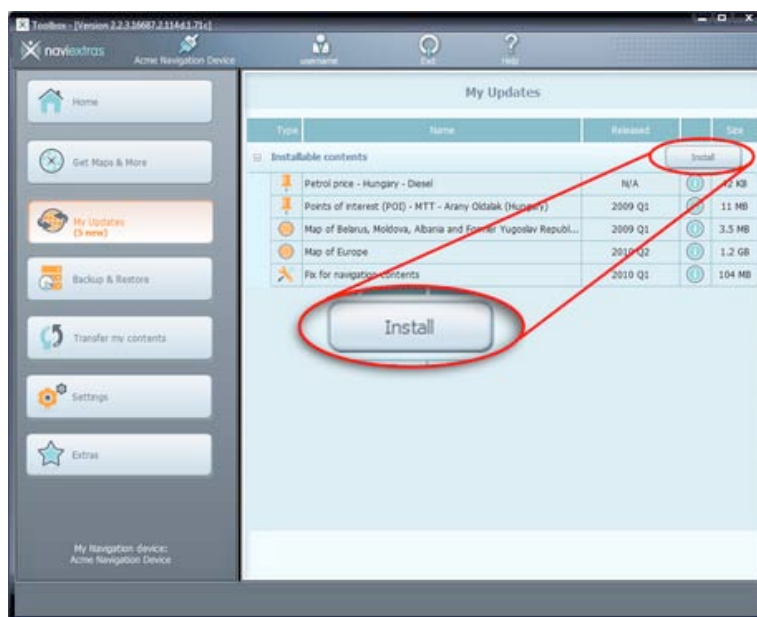

Using the installation wizard

After clicking on the **Install** button, you will be prompted to make a backup. **We strongly recommend to proceed with a backup before downloading and installing updates.**

You may decide to skip backup at your own risk.



Depending on the capabilities of your PC or card reader, the time needed to make a backup may vary. Please wait until the backup process is completed.

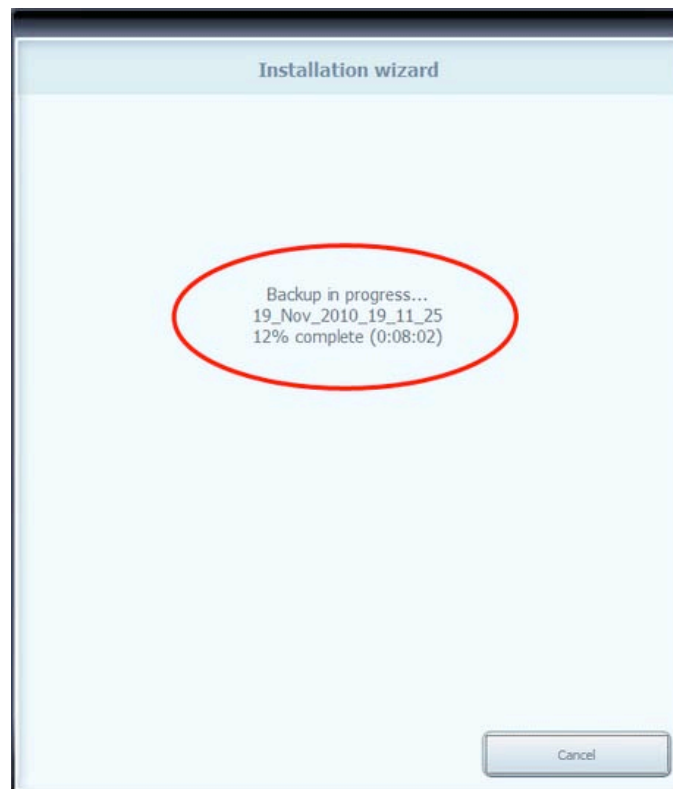

After the backup is made, the installation wizard will continue and will ask you to confirm if you would like to install all listed updates. You can remove any item by un-checking it, and if an update is made up of several content items, you can also select or deselect each item individually. The size of the contents selected for installation and the amount of free space that will remain available on the storage card are indicated below the table.

Press the **Apply** button on the bottom left side of the window to continue.



The Apply button will only be enabled when there is enough free space on your microSD card to install all selected items.

If the size of the selected updates is too large, the additional space required for their installation is shown in red. There are several ways to free up some space on the storage card:

- You can click **Cancel** then go to the **Transfer my contents** menu to free up some space by moving some of your content to your PC. For instructions, see [How to transfer contents between the PC and the navigation device?](#)
- You can select fewer items to install by unchecking their checkboxes in the table.
- If an item is an update to an existing content, there is a trash can icon at the end of its table row. This will delete the content item from your device.

Note that this will erase the content permanently.

You can click **Size details** if you want to view more information about the available space on the storage card.

Toolbox will start downloading the necessary files one by one via the Internet to your PC and copy them to your storage card.

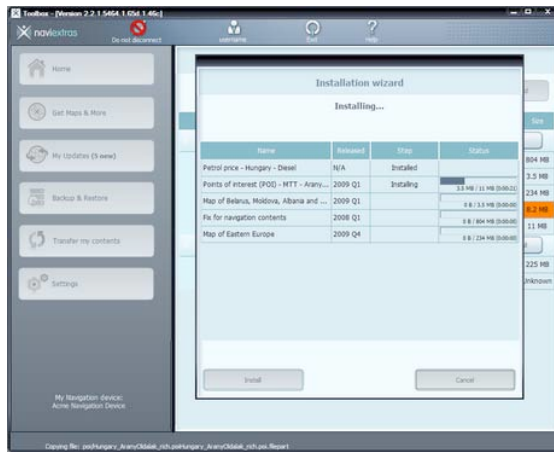

When the installation of all items is finished, a confirmation message appears on the screen.

Upgrading and modifying the installed content items

If you already installed some content items, the installed items will remain listed on the **My Updates** screen together with any potential upgrades that are available for them.

If you can see some items under the header 'Upgrade available', you can use the **Upgrade** button to download and install all these upgrades. The process is very similar to that of the installation wizard.

If you have already installed some items, you will see the header 'My installed contents' in the table, with a **Re-install** button next to it. You can use this button to re-install some contents or uninstall them if you no longer need them. The process is very similar to that of the installation wizard.

In case of uninstalling items, it is strongly recommended to accept the option of making a backup so that you will be able to retrieve the uninstalled contents later.

If your device contains some content items that can no longer be used, you will also see the header 'Expired'. It is recommended to remove these items to free up the space occupied by them.

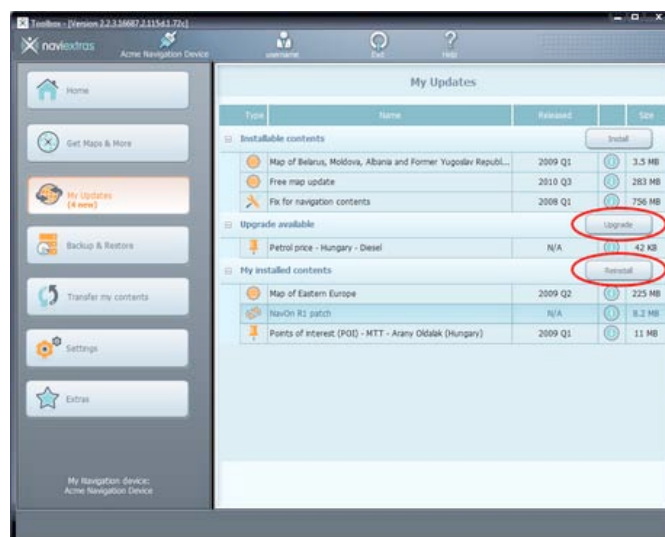

8 How to make or restore a backup of the navigation device?

From time to time, it is useful to make a backup of the contents of your navigation system to avoid losing all or some of your data in case of a hardware error or accidental data loss. This guide explains how to make a backup of your device and how to restore a backup if it becomes necessary.

It is suggested to make a backup in at least the following cases:

- right after you acquire a device with navigation software;
- before using Toolbox to update your navigation software and its content;
- after updating your navigation software.

By default, Toolbox reminds you to make a backup in each of these events.

Creating a backup

After connecting your device and logging in, click the **Backup and Restore** button on the left panel to access the backup and restore functions.

You can see the list of existing backups, which is empty at the beginning. Click **Create Backup** to start making a backup.

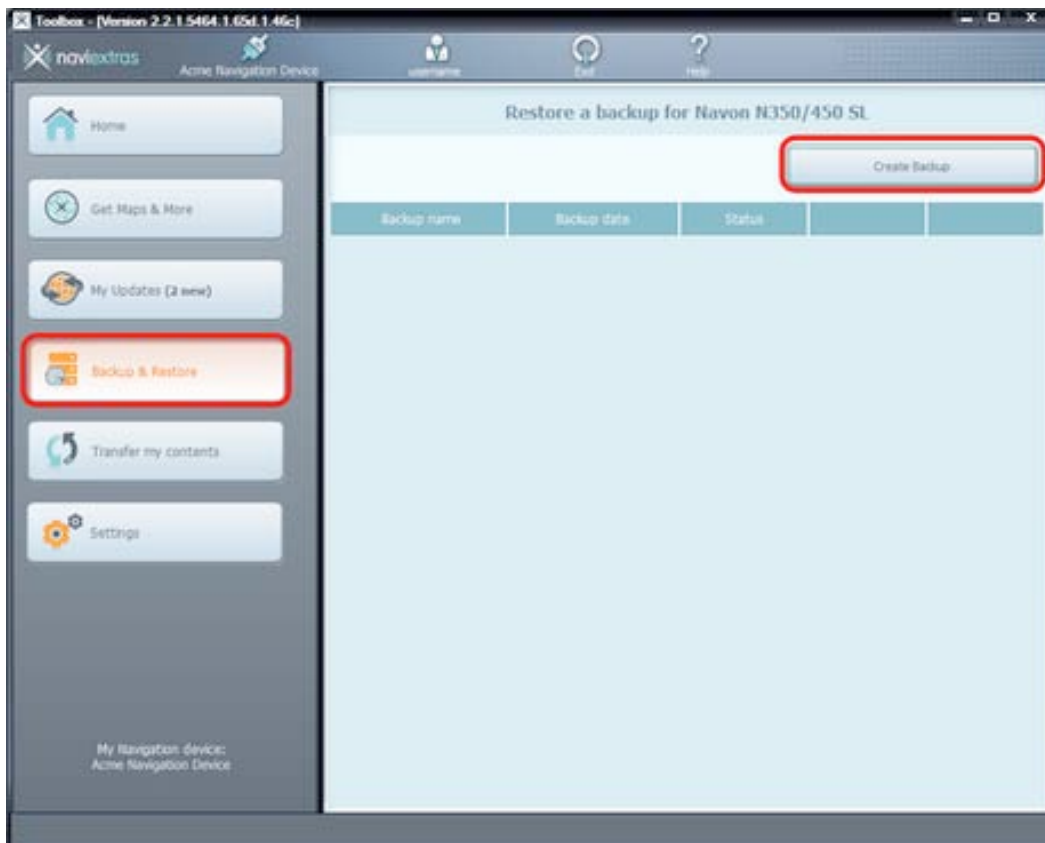

Depending on the capabilities of your PC or card reader, the time needed to make a backup may vary. Please wait until the backup process is completed. Do not remove the microSD card during the process.

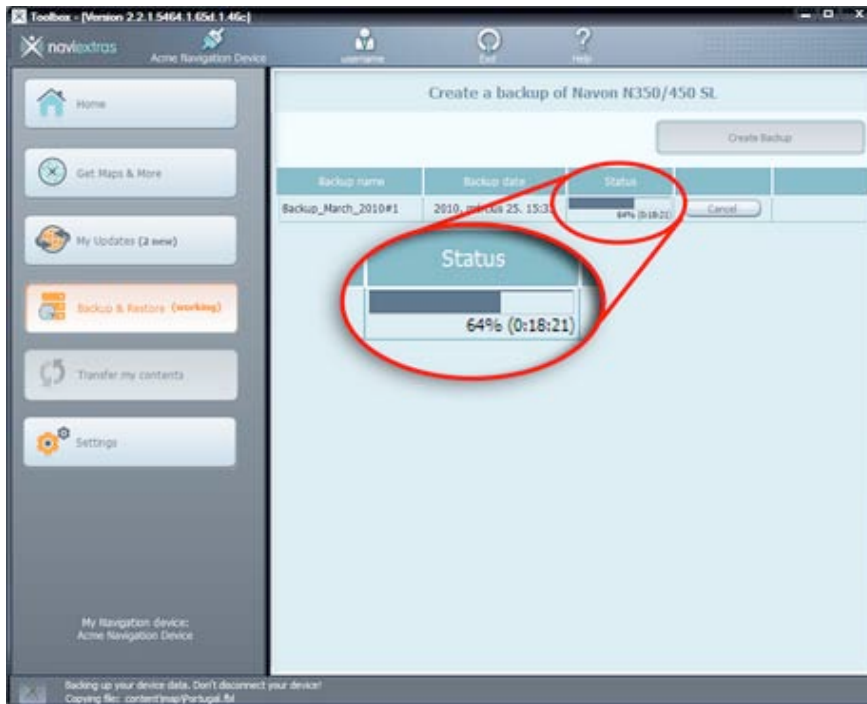

A status bar with the completeness percentage and the estimated time left is shown while creating a backup is in progress. The status bar changes to 'Completed' when the process is finished.

Restoring a backup

If you need to restore a backup, click the **Restore** button in the line that shows the name of the backup.

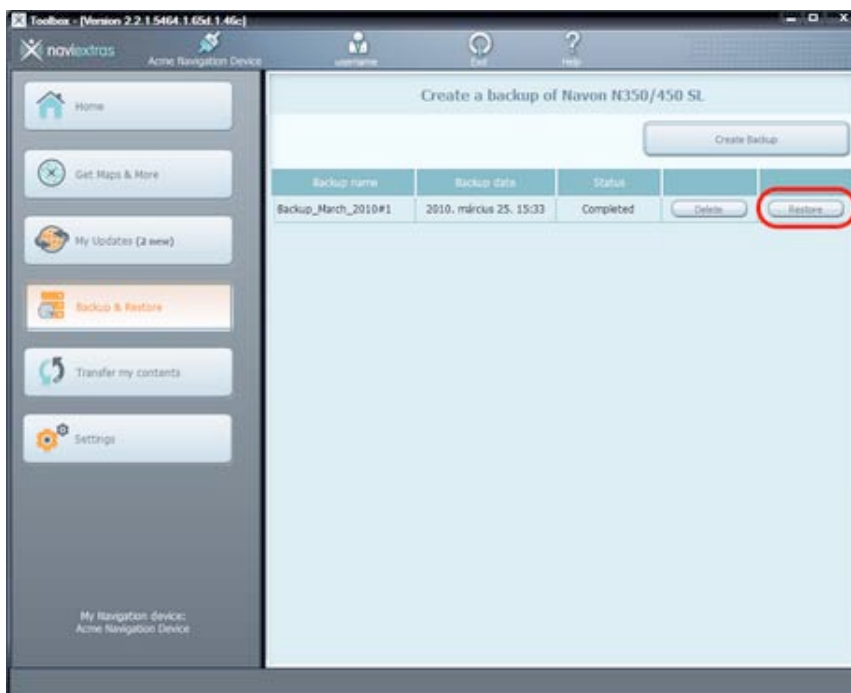

A warning is displayed that if you choose to continue with restoring a backup, all changes and updates will be lost that have been made after the backup date. Accept the warning only if you are sure that no harm will be done to your important data.

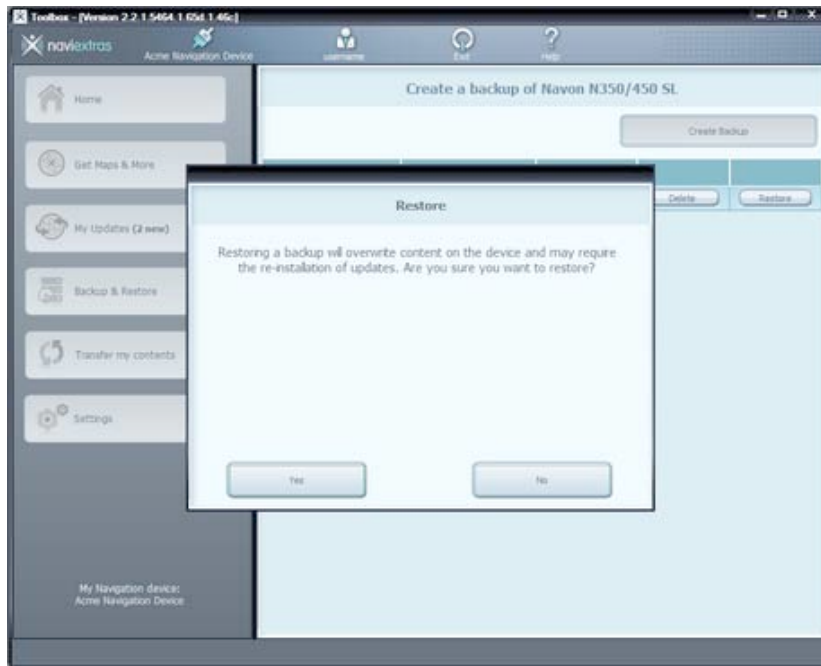

The time needed to restore a backup is similar to the time needed to create a backup. Please wait until the process is completed. Do not remove the microSD card during the process.

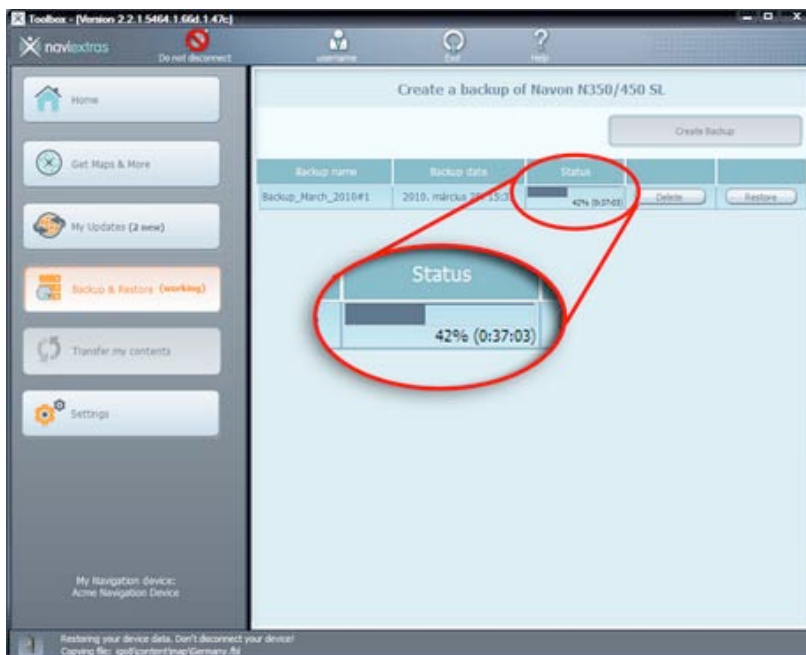

A status bar with the completeness percentage and the estimated time left is shown while restoring a backup is in progress. For a short while, the status bar changes to 'Completed' when the process is finished, then Toolbox re-reads your device contents. You can continue using Toolbox or exit and disconnect your storage card after this point.

9 How to transfer contents between the PC and the navigation device?

This guide explains how to transfer your contents between your navigation device and your PC if you need to free up some space.

In some cases you might need to free up some space on your storage card to make room for new navigation content or media files. Toolbox allows you to transfer your contents between your device and your PC so that you do not permanently lose the content that you decide to remove from the device.

To start transferring your contents, click the **Transfer my contents** button on the left panel. One table lists the contents stored on your device, and another contains those stored on your PC. By default, the 'PC' table is empty.

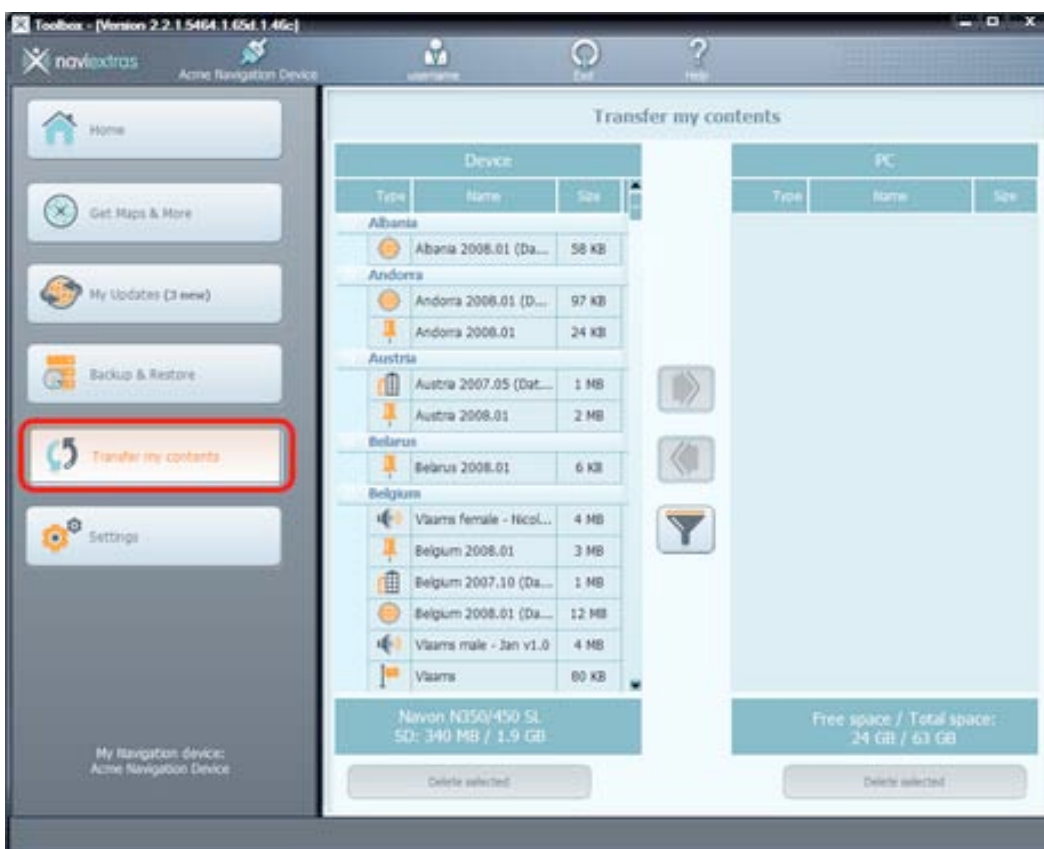

Contents stored on the device are grouped by country. The type of the content is represented by an icon next to its name. If you move the mouse pointer above an icon, a tooltip shows its meaning. There is also a Filter button between the two tables (with the drawing of a funnel) that allows you to filter the list of contents and change their grouping.

You can mark a content for transfer by clicking on its name. You can select several contents in the same way as in Windows—by Ctrl+click and Shift+click.

Having made a selection, start transferring your contents by clicking the arrow button that points towards the 'PC' table.

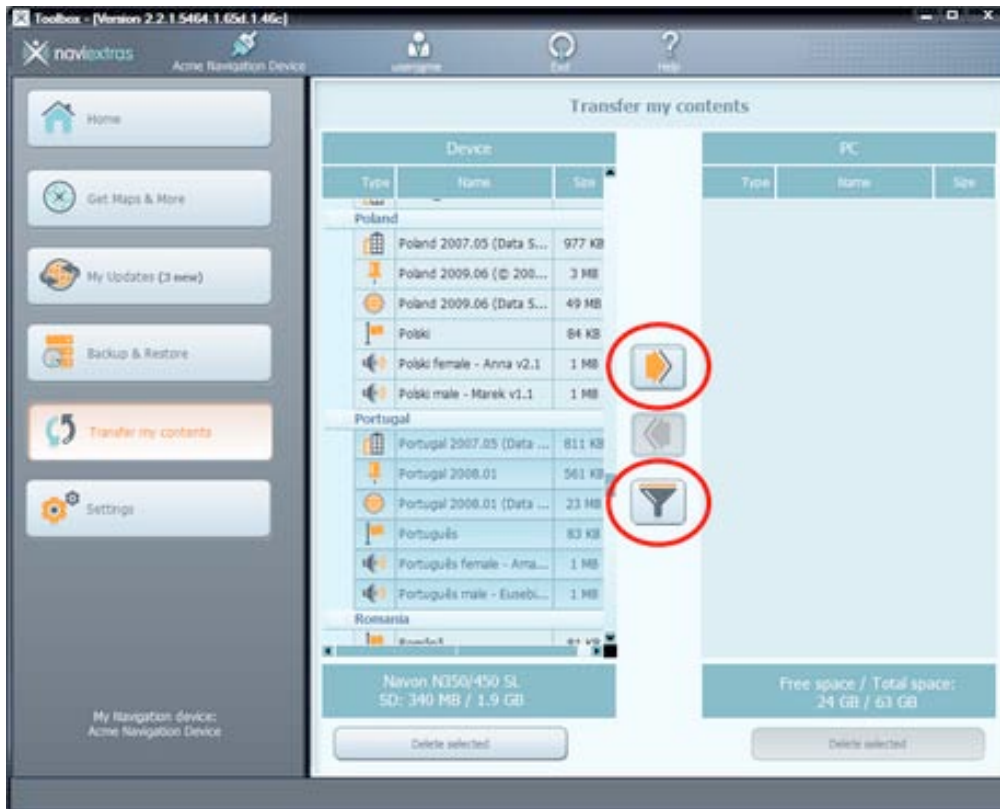

During the transfer, a status window shows the progress. Do not remove the microSD card during the process.

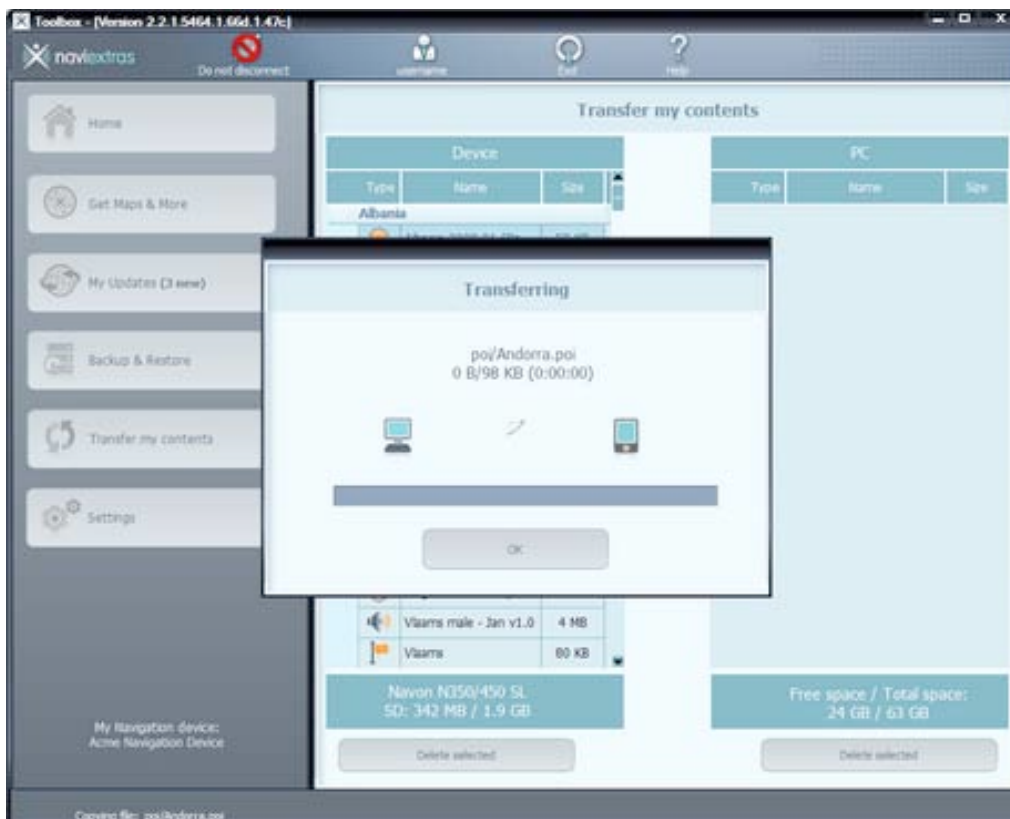

When the transfer is finished, you can see the newly transferred contents in the table on the right side. You can transfer your contents back to your device any time by clicking the arrow button that points to the 'Device' table.

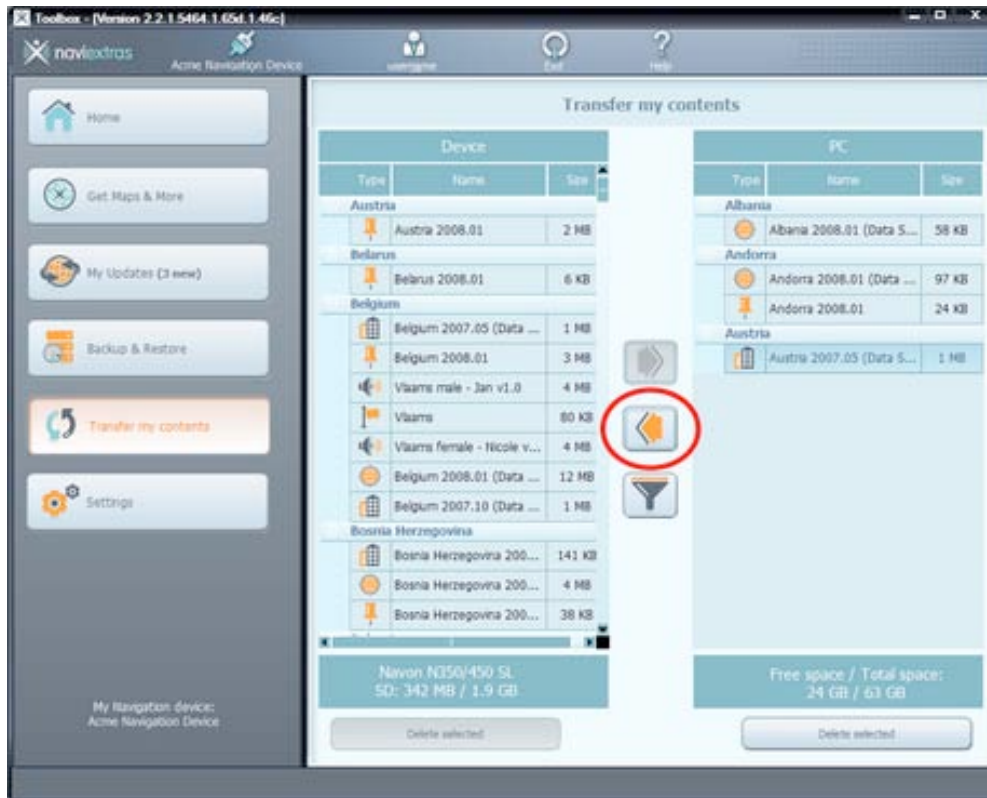

You can also transfer places of interest to your device from an external source. If you want to import places stored in .kml format (for example, from Google Earth), click **Extras** then **Import external contents**. Select the .kml file in the browser window that pops up.

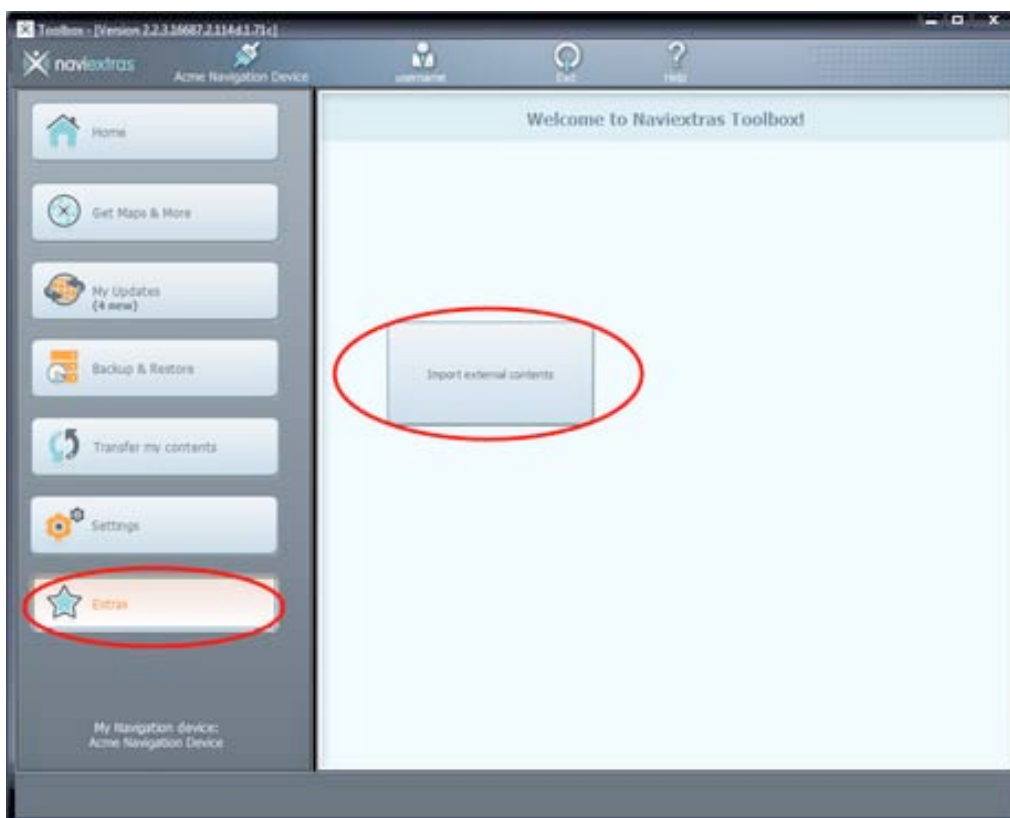

Clarion Co., Ltd.

All Rights Reserved. Copyright © 2011: Clarion Co., Ltd.
Printed in China / Imprime au Chiné / Impreso en China