

# clarion®

**Owner's manual**

使用说明书

사용 설명서

---

## CX501A

**2-DIN Bluetooth® CD/USB/MP3/WMA RECEIVER**

2-DIN Bluetooth® CD/USB/MP3/WMA 接收器

**2-DIN Bluetooth® CD/USB/MP3/WMA 리시버**



Thank you for purchasing this **Clarion** product.

\* Please read this owner's manual in its entirety before operating this equipment.

# Contents

<b>1. FEATURES</b> .....	<b>3</b>
<b>2. PRECAUTIONS</b> .....	<b>4</b>
<b>3. CONTROLS</b> .....	<b>5</b>
Names of the Buttons and Their Main Functions .....	5
<b>4. REMOTE CONTROL</b> .....	<b>6</b>
Functions of Remote Control Unit Buttons .....	6
Inserting the Battery .....	7
<b>5. OPERATIONS</b> .....	<b>8</b>
Basic Operations .....	8
Radio Operations .....	11
CD/MP3/WMA Operations .....	12
Bluetooth Operations .....	15
Operations Common to Each Mode .....	19
<b>6. ACCESSORIES</b> .....	<b>22</b>
USB Operations .....	22
iPod®/iPhone® Operations .....	24
<b>7. TROUBLESHOOTING</b> .....	<b>27</b>
<b>8. ERROR DISPLAYS</b> .....	<b>29</b>
<b>9. SPECIFICATIONS</b> .....	<b>30</b>

## 1. FEATURES



MP3/WMA

USB

- Built in Bluetooth® Handsfree (HFP) and Audio Streaming (A2DP & AVRCP)
- 2V/4ch RCA Output with HPF/LPF and BEAT-EQ with 3 Band Parametric Equalizer
- 728-variable colour display and illuminated key

## 2. PRECAUTIONS

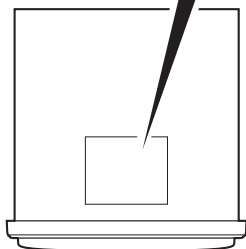

Bottom View of Source Unit

### **⚠ CAUTION**

**USE OF CONTROLS, ADJUSTMENTS, OR PERFORMANCE OF PROCEDURES OTHER THAN THOSE SPECIFIED HEREIN, MAY RESULT IN HAZARDOUS RADIATION EXPOSURE.**

**THE COMPACT DISC PLAYER SHOULD NOT BE ADJUSTED OR REPAIRED BY ANYONE EXCEPT PROPERLY QUALIFIED SERVICE PERSONNEL.**

**CHANGES OR MODIFICATIONS NOT EXPRESSLY APPROVED BY THE MANUFACTURER FOR COMPLIANCE COULD VOID THE USER'S AUTHORITY TO OPERATE THE EQUIPMENT.**

### **Handling Compact Discs**

- Compared to ordinary music CDs, CD-R and CD-RW discs are both easily affected by high temperature and humidity and some of CD-R and CD-RW discs may not be played. Therefore, do not leave them for a long time in the car.
- Never stick labels on the surface of the compact disc or mark the surface with a pencil or pen.

### **Display Screen**

In extremely cold, the screen movement may slow down and the screen may darken, but this is normal.

The screen will recover when it returns to normal temperature.

### **About the registered marks, etc.**

- “Made for iPod,” and “Made for iPhone” mean that an electronic accessory has been designed to connect specifically to iPod, or iPhone, respectively, and has been certified by the developer to meet Apple performance standards. Apple is not responsible for the operation of this device or its compliance with safety and regulatory standards. Please note that the use of this accessory with iPod or iPhone may affect wireless performance. iPhone and iPod are trademarks of Apple Inc., registered in the U.S. and other countries.
- The Bluetooth® word mark and logos are owned by the Bluetooth® SIG, Inc. and any use of such marks by Clarion Co.,Ltd. is under license. Other trademarks and trade names are those of their respective owners.

# 3. CONTROLS

## Names of the Buttons and Their Main Functions

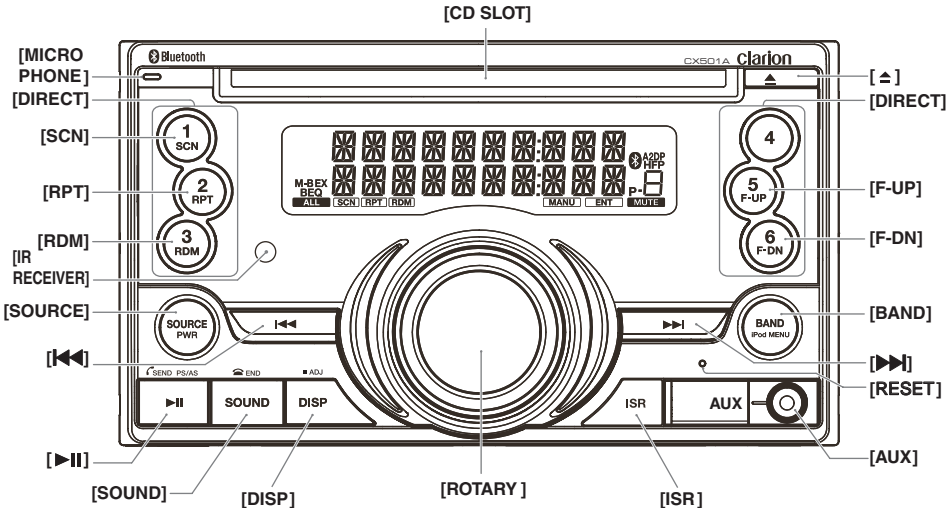

### [MICROPHONE]

- Built-in microphone for Bluetooth telephone.

### [DIRECT] buttons

- Store radio stations in memory or recall it directly while in radio mode.

### [SCN] button

- Perform scan play for 10 seconds of each track while in CD/MP3/WMA/USB mode.

### [RPT] button

- Perform repeat play while in CD/MP3/WMA/USB/iPod mode.

### [RDM] button

- Perform random play while in CD/MP3/WMA/USB/iPod mode.

### [IR RECEIVER]

- Receiver for remote control unit.  
(Operating range: 30° in all directions)

### [SOURCE] button

- Turn the power on/off.
- Press to switch the source.

### [<<<], [>>>] buttons

- Commence fast-forward or fast-reverse mode.
- Press to seek up/down.

### [>||] button

- Perform preset scan while in the radio mode.
- Play or pause a track while in CD/MP3/WMA/USB/iPod mode.

- Receive a call.

### [SOUND] button

- Press to switch to the sound adjust mode.
- Ending a call.

### [DISP] button

- Switch display mode.

### [ROTARY] knob

- Rotate to adjust the volume.
- Rotate to select the desired item.
- Press to ensure the selected item.

### [ISR] button

- Recall ISR radio station in memory.
- Press and hold the button (2 sec.) to store current station into ISR memory (radio mode only).

### [AUX] input jack

- Input jack for connecting external device.

### [BAND] button

- Change bands.

### [F-UP], [F-DN] buttons

- Select folders while in MP3/WMA/USB mode.

### [▲] (EJECT) button

- Eject a disc when it is loaded into the unit.

### [CD SLOT]

- CD insertion slot.

# 4. REMOTE CONTROL

## Functions of Remote Control Unit Buttons

If you buy the RCB-176-200 sold separately, you can enjoy the use of the Remote Control function.

\* Some buttons on the remote control unit have different functions from the corresponding buttons on the main unit.

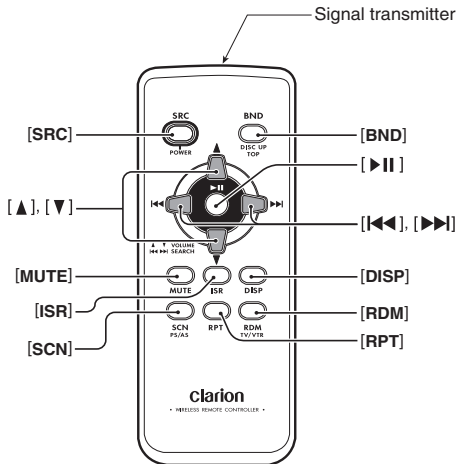

### ● Shared modes

#### [SRC] button

- Press the button to turn on the power.  
Press and hold the button (1 sec.) to turn off the power.
- Use to alternate operation mode among the various modes.

#### [▲], [▼] buttons

- Increases and decreases volume.

#### [MUTE] button

- Turns mute function on and off.

#### [ISR] button

- Recalls ISR radio station stored in memory.
- Press and hold the button (2 sec.) to store current station in ISR memory (radio mode only).

#### [DISP] button

- Press to select the desired display.

### ● Radio mode

#### [BND] button

- Switches reception band.

#### [◀◀], [▶▶] buttons

- Moves preset channels up and down.

#### [SCN] button

- Press to perform preset scan.
- Press and hold the button (2 sec.) to perform auto store.

### ● CD/MP3/WMA and USB modes

#### [◀◀], [▶▶] buttons

- Press to select tracks.
- Press and hold the button (1 sec.) to perform fast-forward/fast-reverse (Except DRM file).

#### [▶||] button

- Switches between playback and pause.

#### [SCN] button

- Press to perform scan play.
- When in MP3/WMA and USB modes, press and hold the button (1 sec.) to perform folder scan play.

#### [RPT] button

- Press to perform repeat play.
- When in MP3/WMA and USB modes, press and hold the button (1 sec.) to perform folder repeat play.

#### [RDM] button

- Press to perform random play.
- When in MP3/WMA and USB modes, press and hold the button (1 sec.) to perform folder random play.

## Functions of Remote Control Unit Buttons

### ● iPod mode

#### [◀◀], [▶▶] buttons

- Press to move the tracks up and down.
- Press and hold the button (1 sec.) to perform fast-forward/fast-reverse.

#### [▶||] button

- Switches between playback and pause.

#### [RPT] button

- Press to perform repeat play.

#### [RDM] button

- Press to perform random play.
- Press and hold the button (1 sec.) to perform all random play.

### ● Bluetooth mode

#### [◀◀], [▶▶] buttons

- Press to move the tracks up and down.

#### [▶||] button

- Switches between playback and pause.

## Inserting the Battery

- ① Turn over the remote control unit and slide the cover in the direction indicated by the arrow in the illustration.
- ② Insert the battery (CR2025) into the insertion guides, with the printed side (+) facing upwards.
- ③ Press the battery in the direction indicated by the arrow so that it slides into the compartment.
- ④ Replace the cover and slide in until it clicks into place.

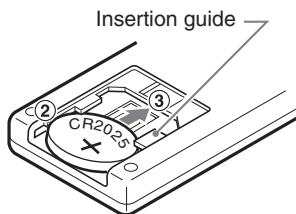
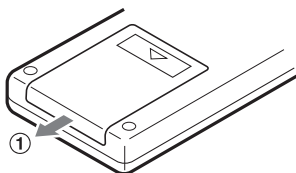

### Notes:

*Misuse may result in rupture of the battery, producing leakage of fluid and resulting in personal injury or damage to surrounding materials. Always follow these safety precautions:*

- Use only the designated battery.
- When replacing the battery, insert properly, with +/- polarities oriented correctly.
- Do not subject battery to heat, or dispose of in fire or water. Do not attempt to disassemble the battery.
- Dispose of used batteries properly.

# 5. OPERATIONS

## Note:

- Be sure to read this chapter referring to the front diagrams of chapter "3. CONTROLS" on page 5.

## Basic Operations

### ⚠ CAUTION

Be sure to lower the volume before switching off the unit power or the ignition key. The unit remembers its last volume setting.

### Turning on/off the power

1. Press the [SOURCE] button to turn on the power.
2. Press and hold the [SOURCE] button (1 sec.) to turn off the power for the unit.

### Selecting a mode

1. Press the [SOURCE] button to change the operation mode.
2. Each time you press the [SOURCE] button, the operation mode changes in the following order:

Tuner → CD/MP3 → USB/iPod →  
BLUETOOTH → AUX → Tuner...

- \* iPod can connect to this unit via USB cable.
- \* iPhone can also be connected to this system and "iPod" appearing in this manual should be referred to as "iPod/iPhone".

### Adjusting the volume

1. Turning the [ROTARY] knob clockwise increases the volume; turning it counterclockwise decreases the volume.
  - \* The volume level is from 0 (minimum) to 33 (maximum).

### Switching the display

Press the [DISP] button to select the desired display.

## Sound Adjustment

You can adjust a sound effect or tone quality to your preference.

### To change sound setting

1. Press the [SOUND] button to switch to the sound adjustment selection display.
  - \* The factory default sound setting is "BEAT EQ".
2. Then press the [◀◀] or [▶▶] button to select the sound adjustment mode. Each time you press the [◀◀] or [▶▶] button, the sound adjustment mode changes as following order:  
 "BEAT EQ" ↔ "M-B EX" ↔ "BALANCE" ↔ "FADER" ↔ "LPF" ↔ "S-W VOL" ↔ "PHASE" ↔ "HPF"
  - \* In the case of display blinking "ENT", you can press the [ROTARY] knob to adjust the setting value.
3. Turn the [ROTARY] knob to adjust the selected sound mode.
4. After completing settings, press the [SOUND] button to return to the previous mode.

### ● Setting the BEAT EQ

This unit is provided with 4 types of sound tone effects stored in memory.

Select the one you prefer.

- \* The factory default setting is "OFF".

- 2-1. Select "BEAT EQ".



## Basic Operations

3-1. Each time you turn the [ROTARY] knob, the tone effect changes in the following order:

“CUSTOM” ↔ “EXCITE” ↔ “IMPACT” ↔ “B-BOOST” ↔ “OFF”

**CUSTOM** : user custom

**EXCITE** : bass and treble emphasized  
mid emphasized

**IMPACT** : bass and treble emphasized

**B-BOOST** : bass emphasized

**OFF** : no sound effect

**When “CUSTOM” is set:**

3-1. Press the [ROTARY] knob.

3-2. Press the [◀◀] or [▶▶] button to select the “BASS”, “MID” or “TREBLE” mode to adjust.

3-3. If you want to set the flat, press the [ROTARY] knob to return to the “CUSTOM” mode, then press and hold the [ROTARY] knob (1 sec.), bass/mid/treble characteristics become flat and switch to the “CUSTOM” mode.

**When “EXCITE/IMPACT/B-BOOST” is set:**

3-1. Press the [ROTARY] knob.

3-2. Turn the [ROTARY] knob to adjust the setting in the range of -3 to +3.

\* The factory default setting is “0”.

3-3. Press the [ROTARY] knob to return to the previous mode.

### ● Adjusting the BASS/MID/TREBLE

This adjustment can be performed only when the BEAT EQ is set to “CUSTOM”.

**Note:**

• While connected with the external amplifiers, please do not set the “BASS/MID/TREBLE” in the maximum level. Otherwise the speakers may be damaged.

3-1. Press the [ROTARY] knob.

3-2. Press the [◀◀] or [▶▶] button to select as following order:

“BASS<G>” ↔ “BASS<F>” ↔  
“BASS<Q>” ↔ “MID<G>” ↔ “MID<F>” ↔  
“MID<Q>” ↔ “TREBLE<G>” ↔  
“TREBLE<F>” ↔ “TREBLE<Q>”

\* The factory default setting is “BASS<G>”.

3-3. Turn the [ROTARY] knob to select the setting.

**BASS<G>**:The factory default setting is “0”.  
(Adjustment range: +7 to -7)

**BASS<F>**:The factory default setting is “50”.  
(Adjustment range: 50/100/200)

**BASS<Q>**:The factory default setting is “1”.  
(Adjustment range: 0.7/1/1.4/2)

**MID<G>** : The factory default setting is “0”.  
(Adjustment range: +7 to -7)

**MID<F>** : The factory default setting is “500”.  
(Adjustment range: 500/1K/2K)

**MID<Q>** : The factory default setting is “1”.  
(Adjustment range: 0.7/1/1.4/2)

**TREBLE<G>**:The factory default setting is “0”.  
(Adjustment range: +7 to -7)

**TREBLE<F>**:The factory default setting is “10K”.  
(Adjustment range: 5K/10K/15K)

**TREBLE<Q>**:The factory default setting is “1”.  
(Adjustment range: 0.7/1/1.4/2)

3-4. Press the [ROTARY] knob to return to the previous mode.

### ● Setting the MAGNA BASS EXTEND

The MAGNA BASS EXTEND does not adjust the low frequencies like the normal sound adjustment function, but emphasizes the deep bass frequencies to provide you with a dynamic sound.

\* The factory default setting is “OFF” (off).

2-1. Select “M-B EX”.

3-1. Turn the [ROTARY] knob to select “ON” or “OFF”.

### ● Adjusting the balance

2-1. Select “BALANCE”.

3-1. Turn the [ROTARY] knob to adjust the balance of the right and left speakers.

\* The factory default setting is “CENTER” (center). (Adjustment range: RIGHT12 to LEFT12 (right 12 to left 12))

### ● Adjusting the fader

2-1. Select “FADER”.

3-1. Turn the [ROTARY] knob to adjust the balance of the rear and front speakers.

\* The factory default setting is “CENTER” (center). (Adjustment range: FRONT12 to REAR12 (front 12 to rear 12))

### ● Setting the subwoofer

You can set the low pass filter of subwoofer.

This adjustment can be performed only when the “REAR/S-W” is set to “S-WOOFER”.

2-1. Select “LPF”.

## Basic Operations

---

3-1. Each time you turn the [ROTARY] knob to select the setting, the setting changes in the following order:

“THROUGH” ↔ “60” ↔ “90” ↔ “120”

\* The factory default setting is “THROUGH”.

### ● Adjusting the subwoofer output volume

You can adjust the volume output from the unit's subwoofer output terminal.

This adjustment can be performed only when the “REAR/S-W” is set to “S-WOOFER”.

2-1. Select “S-W VOL”.

3-1. Turn the [ROTARY] knob to increase or decrease the subwoofer volume.

\* The factory default setting is “0”.  
(Adjustment range: +6 to -6)

### ● Setting the phase

This set can be performed only when the “REAR/S-W” is set to “S-WOOFER”.

2-1. Select “PHASE”.

3-1. Turn the [ROTARY] knob to select as following order:

“NORMAL” ↔ “REVERSE”

\* The factory default setting is “NORMAL”.

### ● Adjusting the high pass filter

2-1. Select “HPF”.

3-1. Each time you turn the [ROTARY] knob to select the setting, the setting changes in the following order:

“THROUGH” ↔ “60” ↔ “90” ↔ “120”

\* The factory default setting is “THROUGH” (through).

#### Note:

- During SOUND adjustment mode, if no operation is performed for more than 10 seconds, this mode can be cancelled and return to previous mode.

# Radio Operations

## Listening to the radio

1. Press the **[SOURCE]** button and select the radio mode.
2. Press the **[BAND]** button and select the radio band. Each time the button is pressed, the radio reception band changes in the following order:  
FM1 → FM2 → FM3 → AM → FM1...

## Tuning

There are 2 types of tuning mode available, auto tuning and step tuning.

### ● Auto tuning

Press and hold the **[◀◀]** or **[▶▶]** button (1 sec.) to automatically seek a station.

### ● Step tuning

Press the **[◀◀]** or **[▶▶]** button to manually tune in a station.

## Recalling a preset station

A total of 24 preset positions (6-FM1, 6-FM2, 6-FM3, 6-AM) exists to store individual radio stations in memory. Press the corresponding **[DIRECT]** button to recall the stored radio frequency automatically.

## Manual memory

1. Select the desired station with seek tuning or manual tuning.
2. Press and hold one of the **[DIRECT]** buttons (2 sec.) to store the current station into preset memory.

## Auto store

Auto store is a function for storing up to 6 stations that are automatically tuned in sequentially. If 6 receivable stations cannot be received, a previously stored station remains unoverwritten at the memory position.

1. Press the **[BAND]** button and select the desired band (FM or AM).
2. Press and hold the **[▶▶]** button for 2 seconds or longer. The stations with good reception are stored automatically to the preset channels.

\* If auto store is performed in the FM bands, the stations are stored in FM3 even if FM1 or FM2 was chosen for storing stations.

## Preset scan

Preset scan receives the stations stored in preset memory in order. This function is useful when searching for a desired station in memory.

1. Press the **[▶▶]** button.
2. When a desired station is tuned in, press the **[▶▶]** button again to continue receiving that station.

### Note:

• *Be careful not to press and hold the **[▶▶]** button (2 sec.), otherwise the auto store function is engaged and the unit starts storing stations.*

## Instant station recall (ISR)

Instant station recall is a special radio preset that instantly accesses a favorite radio station at a touch of a button. The ISR function even operates with the unit in other modes.

### ● ISR memory

1. Select the station that you wish to store in ISR memory.
2. Press and hold the **[ISR]** button (2 sec.).

### ● Recalling a station with ISR

In any mode, press the **[ISR]** button to turn on the radio function and tune the selected radio station. "ISR" appears in the display. Press the **[ISR]** button again to return to the previous mode.

# CD/MP3/WMA Operations

## MP3/WMA

This unit can play back MP3/WMA files.

### Note:

- If you play a file with DRM (Digital Rights Management) for WMA remaining ON, no audio is output (The WMA indicator blinks).

### ● To disable DRM (Digital Rights Management)

1. When using Windows Media Player 9/10/11, click on TOOL → OPTIONS → MUSIC RECORD tab, then under Recording settings, unclick the Check box for RECORD PROTECTED MUSIC. Then, reconstruct files.

Personally constructed WMA files are used at your own responsibility.

## Precautions when creating MP3/WMA file

### ● Usable sampling rates and bit rates

1. MP3: Sampling rate 8 kHz-48 kHz,  
Bit rate 8 kbps-320 kbps / VBR
2. WMA: Bit rate 5 kbps-320 kbps

### ● File extensions

1. Always add a file extension “.MP3” or “.WMA” to MP3 or WMA file by using single byte letters. If you add a file extension other than specified or forget to add the file extension, the file cannot be played.
2. Files without MP3/WMA data will not play. Instead, “- - : - -” will appear in the play time display.

\* When MP3/WMA files are played, a little no sound part is caused between tunes.

### ● Logical format (File system)

1. When writing MP3/WMA file on a CD-R disc or CD-RW disc, please select “ISO9660 level 1, 2 or JOLIET or Romeo” or APPLE ISO as the writing software format. Normal play may not be possible if the disc is recorded on another format.
2. The folder name and file name can be displayed as the title during MP3/WMA play but the title must be within 64 single byte alphabetical letters and numerals (including an extension).
3. Do not affix a name to a file inside a folder having the same name.

### ● Number of files or folders

1. Up to 256 files can be recognized per folder. Up to 999 files can be played.
2. Tracks are played in the order that they were recorded onto a disc. (Tracks might not always be played in the order displayed on the PC.)
3. Some noise may occur depending on the type of encoder software used while recording.

## Disc-In-Play function

As long as the ignition key is turned to the ON or ACC position, this function allows you to turn the power to the unit and start playing the disc automatically when the disc is inserted even if the power is not turned on.

### CAUTION

- Do not try to put your hand or fingers in the disc insertion slot. Also never insert foreign objects into the slot.
- Do not insert discs where adhesive comes out from cellophane tape or a rental CD label, or discs with marks where cellophane tape or rental CD labels were removed. It may be impossible to extract these discs from the unit and they may cause the unit to break down.

## Backup Eject function

Just pressing the  button, ejects the disc even if the power to the unit was not turned on.

Press the [EJECT] button. Remove the disc after it is ejected.

### Notes:

- If a CD (12 cm) is left in the ejected position for 15 seconds, the CD is automatically reloaded (Auto reload).
- If you force a CD into before auto reloading, this can damage the CD.

## Listening to a disc already loaded in the unit

Press the [SOURCE] button to select the CD/MP3/WMA mode.

When the unit enters the CD/MP3/WMA mode, play starts automatically.



If there is no disc loaded, the indication “NO DISC” appears in the title display.

## Loading a CD



Insert a CD into the center of the CD SLOT with the labeled side facing up. “LOADING” appears in the display, the CD enters into the slot, and the play starts.

### Notes:

- Never insert foreign objects into the CD SLOT.

- If the CD is not inserted easily, there may be another CD in the mechanism or the unit may require service.
- Discs not bearing the  or  mark and CD-ROMs cannot be played by this unit.
- Some CDs recorded in CD-R/CD-RW mode may not be usable.

## Pausing play

1. Press the  button to pause play. “PAUSE” appears in the display.
2. To resume CD play, press the  button again.

## Displaying CD titles

This unit can display title data for CD-text/MP3/WMA disc and user titles input with this unit.

1. Each time you press the [DISP] button to change the title display.

### ● CD-TEXT disc

Track → Disc/Artist → Clock → Track ...

### ● MP3/WMA disc



Track → Folder → Title/Album → Artist → Clock → Track ...

### Notes:



- If the CD playing is not a CD-text CD or no user title has been input, “NO TITLE” appears in the display.
- If MP3/WMA disc is not input TAG, “NO TITLE” appears in the display.
- For MP3, supports ID3 Tags V2.3 / 2.2 / 1.1 / 1.0.
- Tag displays give priority to V2.3 / 2.2.
- In the case of album Tags for WMA, the information written into the extension header is displayed.
- Only ASCII characters can be displayed in Tags.

## Selecting a track

### ● Track-up

1. Press the  button to move ahead to the beginning of the next track.
2. Each time you press the  button, the track advances ahead to the beginning of the next track.

### ● Track-down

1. Press the  button to move back to the beginning of the current track.
2. Press the  button twice to move back to the beginning of the previous track.

## CD/MP3/WMA Operations

### Fast-forward/fast-reverse

#### ● Fast-forward

1. Press and hold the [▶▶] button (1 sec.).

#### ● Fast-reverse

1. Press and hold the [◀◀] button (1 sec.).

\* For MP3/WMA discs, it takes some time until the start of searching and between tracks. In addition, the playing time may have a margin of error.

### Folder Select

This function allows you to select a folder containing MP3/WMA files and start playing from the first track in the folder.

1. Press the [F-UP] or [F-DN] button.  
Press the [F-UP] button to move the next folder. Press the [F-DN] button to move the previous folder.
2. To select a track, press the [◀◀] or [▶▶] button.

### Other various play functions

#### ● Scan play

This function allows you to locate and play the first 10 seconds of all the tracks recorded on a disc.

1. Press the [SCN] button to perform scan play.

#### ● Folder scan play

This function allows you to locate and play the first 10 seconds of the first track of all the folders on an MP3/WMA disc.

1. Press and hold the [SCN] button (1 sec.) to perform folder scan play.

#### ● Repeat play

This function allows you to play the current track repeatedly.

1. Press the [RPT] button to perform repeat play.

#### ● Folder repeat play

This function allows you to play a track currently being played in the MP3/WMA folder repeatedly.

1. Press and hold the [RPT] button (1 sec.) to perform folder repeat play.

#### ● Random play

This function allows you to play all tracks recorded on a disc in a random order.

1. Press the [RDM] button to perform random play.

#### ● Folder random play

This function allows you to play all the tracks of all the folders recorded on an MP3/WMA disc in a random order.

1. Press and hold the [RDM] button (1 sec.) to perform folder random play.

#### ● To cancel play

1. Press the operating button previously selected.

\* The various play mode is canceled and the various play off mode appears in the display for 2 seconds.

# Bluetooth Operations

The Bluetooth allows you to utilize your car's built-in audio system for wireless mobile phone or music handsfree communication.

Some Bluetooth mobile phones have the audio features, and some portable audio players support Bluetooth feature.

This system can play audio data stored in a Bluetooth audio device.

The car stereo with Bluetooth will be able to retrieve phonebook contacts, received call, dialed call, missed call, incoming calls, outgoing call, redial call and listen to music.

## Notes:

- \* This system will not operate or may operate improperly with some Bluetooth audio players.
- \* For detailed information on the playable Bluetooth audio players, see our home page: [www.clarion.com](http://www.clarion.com)
- \* When an audio device is paired, the following operations are the same as for CD mode:

\* **Pause**

\* **Track selection**

\* **Fast-forward**

\* **Fast-reverse**

The titles and the play time can not appear in the display.

See “**CD/MP3/WMA Operations**” (pages 12-14) for details.

## Basic Operations

### Select Bluetooth

1. Press the [SOURCE] button to switch the source.
2. You can press and hold the [SOUND] button to disconnect the currently connected device.

### Switch the display

Press the [DISP] button to select the display in the following order:

“BT TEL” → “BT AUDIO” → “- - : - -”

- \* The connected device name will appear in the display.

### Making a call

There are 4 ways to make outgoing call.

#### ● Direct Number Call

Outgoing call can be made by entering telephone numbers directly via the car stereo. Telephone number uses 0, 1, 2, 3, 4, 5, 6, 7, 8, 9, \*, #, and +.

1. Press the [BAND] button to select “DIAL NUMBER”.
2. Press the [ROTARY] knob.
3. Press the [◀◀] or [▶▶] button to move the cursor.
4. Turn the [ROTARY] knob to select the numbers.
5. Press the [ROTARY] knob to call the mobile phone No.

\* Press the [SOUND] button to end the call.

#### ● Call from Phonebook

User can search the contact name in the phonebook and make call.

Alternatively, user can call from mobile phone.

1. Press the [BAND] button to select “PHONE BOOK”.
2. Press the [▶▶] button to enter the contact name mode (In this case, turn the [ROTARY] knob to select the desired contact name).
3. When the contact name is displayed, press the [▶▶] or [◀◀] button to select the contact name's phone number.
4. Press the [ROTARY] knob to call the mobile phone No.

\* Press the [SOUND] button to end the call.

#### ● Answering a call

1. You can answer an incoming call by pressing [▶||] button.
- \* Press the [SOUND] button to reject an incoming call.

#### ● Switch to the secret call mode

1. Press the [BAND] button to switch to the secret call mode.
- \* When you switch to the secret call mode, you will not hear the call from set and only can hear it from your mobile phone.

## Bluetooth Operations

### ● Received/Dialled/Missed Call History

You can search any Received/Dialled/Missed Call History.

1. Press the [BAND] button to select "HISTORY".
2. Press the [▶▶] button to enter the contact name mode (In this case, turn the [ROTARY] knob to select the desired contact name).
3. When the contact name is displayed, press the [◀◀] or [▶▶] button to select the contact name's phone number.
4. Press the [ROTARY] knob to call the mobile phone No.

### ● Redial a call

You can call a redial phone No.

1. Press the [BAND] button to select "REDIAL".
2. Press and hold the [ROTARY] knob (1 sec.) to call the redial phone No.
  - \* Press the [SOUND] button to end the call.

### To change Bluetooth adjustment setting

1. Press and hold the [DISP] button (1 sec.) to switch to the Bluetooth adjustment selection display.
2. Press the [◀◀] or [▶▶] button to select the "item name".
 

"PAIRING" ↔ "SELECT" ↔ "DELETE" ↔ "DISCONNECT" ↔ "ADD PHONE BOOK" ↔ "DEL NO. PHONE BOOK" ↔ "HISTORY DELETE ALL" ↔ "MIC GAIN" ↔ "RING VOL" ↔ "TONE SEL" ↔ "NOISE" ↔ "AUTO ANS" ↔ "AUTO CON" ↔ "PASS KEY" ↔ "ADDRESS" ↔ "BT NAME" ↔ "BT FW"
3. Turn the [ROTARY] knob to select the "desired setting value".
  - \* In the case of display blinking "ENT", you can press the [ROTARY] knob to adjust the setting value.
  - \* After completing settings, press the [DISP] button to return to the previous mode.

### ● PAIRING

This option is used to perform Bluetooth pairing with the mobile phone and audio.

Up to a maximum of 5 mobile phones and an audio device can be paired.

- 2-1. Select "PAIRING".
- 3-1. Press the [ROTARY] knob.
- 3-2. Turn the [ROTARY] knob to select "TELEPHONE" or "AUDIO".

3-3. After select the "TELEPHONE", press and hold the [ROTARY] knob (1 sec.).

4-1. Turn the [ROTARY] knob to select "SEARCH" or "WAIT".

5-1. Press and hold the [ROTARY] knob (1 sec.).

\* When the "SEARCHING" appears in the display, you can press the [ROTARY] knob to stop search, then the list search appears.

"SEARCH" mode: User can search the Bluetooth mobile phone or audio device.

"WAIT" mode: User can search this unit via the mobile phone or audio device.

6-1. After the search, turn the [ROTARY] knob to select the desired Bluetooth mobile phone.

7-1. Press and hold the [ROTARY] knob (1 sec.) to pair.

#### Note:

- After paired successfully, the phone book numbers can be stored in five memories and every memory can store 100 telephone numbers.

### ● SELECT

This is a setting for user to select one of the paired mobile phones or audio.

2-1. Select "SELECT".

3-1. Press the [ROTARY] knob, then the paired mobile phones appears in the display.

4-1. Turn the [ROTARY] knob to choose one of the 5 mobile phones.

5-1. Press and hold the [ROTARY] knob (1 sec.) to connect.

Connected device will be able to use all the functionalities provided.

### ● DELETE

This is a setting for user to delete one of the paired device from the list.

2-1. Select "DELETE".

3-1. Press the [ROTARY] knob, then the device appears in the display.

4-1. Turn the [ROTARY] knob to choose one of the 5 phones and an audio device.

5-1. Press and hold the [ROTARY] knob (1 sec.) to delete the paired device.

#### Notes:

- After deleting the device, the phone book and the call history records will be deleted too.
- Deleted paired device will not automatically rearrange in the paired device list.



### ● DISCONNECT

This option is used to disconnect the currently connected device.

- 2-1. Select "**DISCONNECT**".
- 3-1. Press and hold the **[ROTARY]** knob (1 sec.) to disconnect.
  - \* Press and hold the **[SOUND]** button (2 sec.) to disconnect.

### ● ADD PHONE BOOK

This option is used to add one of the phone No.

- 2-1. Select "**ADD PHONE BOOK**".
- 3-1. Press the **[ROTARY]** knob (1 sec.), then the "**CHECKING**" appears in the display.
  - \* If your phone has the PBAP function, the "**RECEIVING**" will appear in the display, and it will receive the phone NO. automatically. When the transfer is complete, the "**COMPLETED**" will appear in the display for 2 sec. Then it returns to the "**ADD PHONE BOOK**" item.
  - \* If your phone doesn't have the PBAP function, the "**WAITING**" will appear in the display. At the same time the phone No. from the paired phone book list is sent out, then there is a prompt on the mobile phone if it is successful. Then it returns to the "**ADD PHONE BOOK**" item.
  - \* Some mobile phones cannot transfer the phone book to this unit because of the less word and the language type. In this time, please edit your phone book in other language, and transfer it once again.
- 3-2. Press the **[ROTARY]** knob again to stop the receiving of the phone NO. and the "**CANCEL**" will appear in the display for 2 sec. and then the "**CANCELED**" will appear in the display for 1 sec. Then it returns to the "**ADD PHONE BOOK**" item.

### ● DEL NO. PHONE BOOK

This option is used to delete one of or all phone No. of the added phone book.

- 2-1. Select "**DEL NO. PHONE BOOK**".
- 3-1. Press the **[ROTARY]** knob.
- 4-1. Turn the **[ROTARY]** knob to select "**1 DEL**" or "**ALL DEL**".
- 5-1. When you select "**1 DEL**", press the **[ROTARY]** knob, then turn the **[ROTARY]** knob to select one of the desired phone No.
- 6-1. Press the **[ROTARY]** knob, then the "**DELETE?**" appears in the display.
- 7-1. Press the **[ROTARY]** knob (1 sec.) to delete.

### Note:

- \* If you want to transfer or handle this unit, please perform "**DELETE**", "**ADD PHONE BOOK**" and "**DEL NO. PHONE BOOK**" function to delete all of your personal information.

### ● HISTORY DELETE ALL

This option is used to delete all of the call records.

- 2-1. Select "**HISTORY DELETE ALL**".
- 3-1. Press the **[ROTARY]** knob, then the "**CONFIRM?**" appears in the display.
- 4-1. Press the **[ROTARY]** knob (1 sec.), then the "**DELETING**" appears in the display, delete all of the call records successfully.

### ● MIC GAIN

MIC gain can be set by each paired mobile phone device. Each registered device has unique MIC gain setting.

- 2-1. Select "**MIC GAIN**".
- 3-1. Turn the **[ROTARY]** knob to change the MIC gain setting.
  - \* The factory default setting is "3". (Adjustment range: 1 to 5)

### ● RING VOL

This option is used to change the ringing volume by each paired mobile phone device.

- 2-1. Select "**RING VOL**".
- 3-1. Turn the **[ROTARY]** knob to change the ringing volume.
  - \* The factory default setting is "5". (Adjustment range: 1 to 10)

### ● TONE SEL

The system can ring if the mobile phone cannot ring when the Bluetooth connection has been established.

- 2-1. Press "**TONE SEL**".
- 3-1. Turn the **[ROTARY]** knob to select "**INTERNAL**" or "**AUTO**".
  - \* The unit setting is "**AUTO**".
  - "**INTERNAL**": Adjust tone in the car Bluetooth system.
  - "**AUTO**": Automatic adjustment is enabled in the paired mobile phone.

### ● NOISE

This option is used to set noise volume in the car Bluetooth system.

- 2-1. Press "**NOISE**".
- 3-1. Turn the **[ROTARY]** knob to select "**LOW**" or "**HIGH**".
  - \* The factory default setting is "**LOW**".

## Bluetooth Operations

### ● AUTO ANS

This is a setting to determine whether any incoming call will be automatically or manually answered.

\* The factory default setting is "OFF".

2-1. Select "AUTO ANS".

3-1. Turn the [ROTARY] knob to select "ON" or "OFF".

**ON:** Any incoming call is automatically answered in 5 seconds.

**OFF:** User needs to manually answer the call.

### ● AUTO CONNECT

This function allows the Bluetooth to be connected automatically with previously connected device. Connection can be established at any source mode.

\* The factory default setting is "OFF".

2-1. Select "AUTO CON".

3-1. Turn the [ROTARY] knob to select "ON" or "OFF".

**ON:** Automatic connection is enabled.

**OFF:** Automatic connection is disabled.

### ● PASS KEY

This PASS KEY is used during pairing mode. A maximum of 10 digits can be changed through the car stereo.

\* The factory default PASS KEY is "1234".

2-1. Select "PASS KEY".

3-1. Press the [ROTARY] knob.

4-1. Press the [◀◀] or [▶▶] button to remove the cursor.

5-1. Turn the [ROTARY] knob to select the desired digits.

6-1. Press and hold the [ROTARY] knob (1 sec.) to store in memory.

### ● ADDRESS

This will hold the unique Bluetooth address. The address is 16 figures.

2-1. Select "ADDRESS".

The Bluetooth address 8 figures appears in the display.

3-1. Turn the [ROTARY] knob to display.

### ● Bluetooth Name

This will display the name of the Bluetooth.

2-1. Select "BT NAME".

The Bluetooth name appears in the display.

### ● Bluetooth Firmware version

This will display the Firmware version of the Bluetooth.

2-1. Select "BT FW".

The Bluetooth Firmware version appears in the display.

## To change adjustment setting

1. Press and hold the [DISP] button (1 sec.) to switch to the adjustment selection display.
2. Press the [◀◀] or [▶▶] button to select the "item name".  
 "CLOCK" ↔ "CONTRAST" ↔  
 "COLOR" ↔ "CODE" ↔ "SCRN SVR" ↔  
 "SCROLL" ↔ "DIMMER" ↔  
 "BLINKLED" ↔ "REAR/S-W" ↔  
 "INT-SW" ↔ "RESET"
3. Turn the [ROTARY] knob to select the "desired setting value".  
 \* In the case of display blinking "ENT", you can press the [ROTARY] knob to adjust the setting value.  
 \* After completing settings, press the [DISP] button to return to the previous mode.

### ● Setting the clock

- 2-1. Select "CLOCK".
- 3-1. Press the [ROTARY] knob.
- 3-2. Press the [◀◀] or [▶▶] button to select the hour or the minute.
- 3-3. Turn the [ROTARY] knob to set the correct time.  
 \* The clock is displayed in 12-hour format.
- 3-4. Press the [ROTARY] knob to store the time into memory.

#### Note:

- You cannot set the clock when it is displayed with only the ignition on. If you drain or remove the car's battery or take out this unit, the clock is reset. While setting the clock, if another button or operation is selected, the clock set mode is canceled.

### ● Setting the contrast

You can adjust the display contrast to match the angle of installation of the unit.

- \* The factory default setting is "10".  
(Adjustment level: 1 to 16)

- 2-1. Select "CONTRAST".
- 3-1. Turn the [ROTARY] knob to adjust the contrast.

### ● Setting the button illumination

- 2-1. Select "COLOR".
- 3-1. Turn the [ROTARY] knob to select the color type.

### ● Setting COLOR SCAN mode

As selecting "COLOR SCAN", the color automatically changes.

- \* The factory default setting is "COLOR SCAN".
- \* After 3 seconds the color changes to the other.

### ● Setting USER mode

The factory default setting is "RED 8" (red), "GREEN 8" (green), "BLUE 8" (blue).

As selecting "USER COLOR 1, 2, 3", press the [ROTARY] knob to enter the setting.

1. Press the [◀◀] or [▶▶] to select "RED", "GREEN" or "BLUE".
2. Turn the [ROTARY] knob to select from 0 to 8.
3. Press and hold the [ROTARY] knob for 2 seconds or longer to store the color in memory and cancel the setting mode.

### ● Setting the anti-theft function (CATS)

"CATS" is the acronym of "Clarion Anti-Theft System". When you set a PIN code (called as "Personal Code"), a theft is prevented by disabling the operation of the unit at the theft.

### ● Setting your Personal Code

- 2-1. Select "CODE".
- 3-1. Press the [ROTARY] knob.  
The set personal code screen appears.
- 4-1. Press the [DIRECT] buttons [1]-[6] to enter your desired 4-digit Personal Code.
- 5-1. Press and hold the [ROTARY] knob (2 sec.).  
The entered Personal Code will be set, and it will return to the previous screen.

#### Note:

- Write down your Personal Code in case you forget it.

### ● Erasing the Personal Code

- 2-1. Select "CODE".
- 3-1. Press the [ROTARY] knob.  
The ERASE PERSONAL CODE screen appears.
- 4-1. Enter the Personal Code currently.
- 5-1. Press and hold the [ROTARY] knob (2 sec.) or longer.  
Entering a Personal Code mode is cancelled.

## Operations Common to Each Mode

### • When the ENTER PERSONAL CODE screen appears

The ENTER PERSONAL CODE screen will be displayed when turning the ACC power on after performing the following operations:

- The car battery was replaced.
- The backup power was cut off.
- The [RESET] button was pressed.

#### Note:

• If you have lost your Personal Code, please contact Clarion customer service.

1. Enter your Personal Code currently set.
2. When the correct Personal Code is entered, the unit will restart from the initial startup screen.

#### Notes:

• When you enter a wrong Personal Code, the message "LOCK - - -" is displayed and the Personal Code entry is prohibited for a while. This prohibited time is changed according to the number of times of wrong code entry as follows:

- 1 to 6 times: 15 seconds
- 7 times or more: 15 minutes

### ● Turning the screen saver function on or off

This unit is provided with the screen saver function which allows you to show various kinds of patterns and characters in the operation status indication area of the display in a random order. You can turn on or off this function. If the button operation is performed with the screen saver function on, the operation display corresponding to the button operation is shown for about 30 seconds and the display returns to the screen saver display.

\* The factory default setting is "ON".

- 2-1. Select "SCRN SVR".
- 3-1. Turn the [ROTARY] knob to select the setting.  
Each time you turn the [ROTARY] knob, the setting changes in the following order:  
"OFF" ↔ "ON"

### ● Setting the method for title scroll

Set how to scroll in CD-TEXT, MP3/WMA title.

\* The factory default setting is "ON".

- 2-1. Select "SCROLL".
- 3-1. Turn the [ROTARY] knob to select "ON" or "OFF".
  - ON:  
To scroll automatically.
  - OFF:  
To scroll just 1 time.

### ● Setting the dimmer control

You can set the dimmer control "ON" or "OFF".

\* The factory default setting is "ON".

- 2-1. Select "DIMMER".
- 3-1. Turn the [ROTARY] knob to select "ON" or "OFF".

### ● Anti-theft indicator

The red Anti-theft indicator is a function for preventing theft. When the ACC is off, this indicator blinks.

\* The factory default setting is "OFF".

- 2-1. Select "BLINKLED".
- 3-1. Turn the [ROTARY] knob to select "ON" or "OFF".

### ● Selecting Rear or Subwoofer

\* The factory default setting is "REAR".

- 2-1. Select "REAR/S-W".
- 3-1. Turn the [ROTARY] knob to select "REAR" or "S-WOOFER".

### ● Cellular phone interrupt setting

Connect this unit and your cellular phone with phone mute lead.

\* The factory default setting is "OFF".

- 2-1. Select "INT-SW".
- 3-1. Turn the [ROTARY] knob to select the setting. Each time you turn the [ROTARY] knob, the setting changes in the following order:  
"OFF" ↔ "MUTE"
  - OFF:  
This unit continues normal operation even when the cellular phone is used.
  - MUTE:  
The sound from this unit is muted during telephone calls.

## Operations Common to Each Mode

### ● Performing memory reset

This function allows you to reset adjusted settings in the memory. The stored settings like last operation mode, volume setting, preset channels, MAGNA BASS EXTEND setting, adjust mode settings and sound mode settings can be formatted by this function.

#### **Note:**

- The settings will remain in the memory even if you turn the power off or press the reset button.

2-1. Select “**RESET**”.

3-1. Press and hold the [**ROTARY**] knob (1 sec.).

“**RESET**” appears in the display, then the unit will be restarted automatically and the memory will be cleared.

### **AUX function**

This system has an external input jack on the front panel so you can listen to sounds and music from external devices connected to this unit.

### ● Selecting AUX IN sensitivity

Make the following settings to select the sensitivity when sounds from external devices connected to this unit are difficult to hear even after adjusting the volume.

\* The factory default setting is “**MID**”.

1. Press and hold the [**DISP**] button (1 sec.).
2. Select “**AUX SENS**”.
3. Turn the [**ROTARY**] knob to select “**HIGH**”, “**MID**” or “**LOW**”.

#### **Note:**

- When **AUX** mode is selected, **AUX IN** sensitivity can be set.

# 6. ACCESSORIES

## USB Operations

### USB memory device operation

#### Note:

- The following operations are the same as for CD mode:
    - \*Pause
    - \*Track selection
    - \*Fast-forward/fast-backward (Except DRM file)
    - \*Scan play
    - \*Repeat play
    - \*Random play
    - \*Folder selection
- See “CD/MP3/WMA Operations” (pages 12-14) for details.

### About USB memory

- USB is an acronym for Universal Serial Bus, and refers to an external bus standard supporting data transfer rates of 12 Mbps.
- This unit is compatible with USB 1.1/2.0 with maximum data transfer rates of 12 Mbps.
- USB memory devices that can be played by connecting to the unit’s USB cable are limited to those recognized as “USB mass storage class devices”; operation is not guaranteed with all USB memory devices.
  - \* Devices compatible with “USB Mass Storage Class” can be used merely by connecting to the host device, without need for special drivers or application software.
- Consult the manufacturer of your USB memory device for information regarding whether it is supported by “USB Mass Storage Class” standards.
- Audio files playable on this unit are limited to MP3/WMA files. For details, see the section “MP3/WMA” (page 12).  
Copy-protected WMA files cannot be played on this unit.
- The Podcast files of iTunes Store that stored in the USB memory device can not be played. Besides, the data that edit through some softs such as the Tag edit soft may not be played.
- To prevent the accidental loss of data, always back up important data on your computer.
- This unit does not support connections to a computer. In addition, connections made through a USB hub device are also not supported.

- When a USB memory device is composed of two or more drives, only one of the drives will be detected.
- USB memory devices with security functions cannot be played.
- The order in which tracks are recorded may differ depending on the USB memory device connected (the actual playback order may not be the same as that indicated on your computer’s display).

### CAUTION

- **Insert and remove a USB memory device only when the device is not being accessed. Connecting or disconnecting the device at the following times may result in the loss of data:**
  - If the USB memory device is removed or power is disconnected during writing to the device.
  - When the device is subjected to static electricity or electric noise.
- **Do not leave a USB memory device unattended in an automobile. Exposure to direct sunlight or high temperatures may cause deformation or other malfunction of the USB memory device.**

### Connecting a USB memory device

1. Connect the USB memory device to the USB connector.

Playback will begin from the first file recorded on the device.

- \* When a USB device is connected, it will switch to USB mode automatically. If the device is not recognized, press the [SOURCE] button to switch the source to the device.
- \* Always insert the device fully into the connector. Incomplete connections may cause the device not to be recognized.
- \* Depending on the number of tracks recorded, some amount of time may be required until all tracks are read into the unit.
- \* The order in which tracks are recorded may differ depending on the device connected (the actual playback order may not be the same as that indicated on your computer's display).

### To listen to tracks on a connected USB memory device

1. Press the [SOURCE] button to switch the source. When USB memory device is selected, playback (except DRM files) will begin from the location at which playback was previously stopped.
  - \* When a USB memory device is connected, the USB mode will be displayed.
  - \* When a USB memory device is disconnected and then reconnected, playback will begin from the beginning of the USB memory device.

### To stop play

1. Press the [SOURCE] button and switch the function to a source other than the USB memory.

### CAUTION

**Do not remove the USB memory device when the USB mode is selected, since it may result in loss or damage to data on the USB memory device.**

**Always backup and save important data on your computer.**

2. Remove the USB memory device from the USB connector.

# iPod®/iPhone® Operations

This section describes operations when connected to an Apple iPod via the USB cable. iPod can be connected by using the connector cable supplied with the iPod, but in this case, you can enjoy its audio sound only. To enjoy video movies stored in the iPod with video displaying them on this unit, it is required to use the special monitor and connector cable (CCA-723/CCA-748) separately sold.

## Notes:

- See the iPod Owner's Manual for details regarding operation conditions.
- The unit will not operate, or may operate improperly with unsupported versions.
- For a list of compatible Apple iPod unit with this model, please contact your Clarion dealer or [www.clarion.com](http://www.clarion.com).

## Connecting an iPod

When an iPod is connected to the USB slot, "Shuffle" set on the iPod will become as follows:

- "Shuffle (Albums)" play → Random play
- "Shuffle (Songs)" play → All random play

The iPod has two modes, the "Play mode" and the "iPod menu mode" for selecting tracks.

Switch between these modes by pressing the [BAND] button (1 sec.).

## Note:

- To connect iPod, please use the USB cable attached in iPod.

## Select iPod mode

1. Press the [SOURCE] button.  
Playback will begin from the last file that was played on the iPod.

## Notes:

- The following operations in Play mode operate the same as in CD mode:
  - \*Track selection: [◀◀], [▶▶]
  - \*Fast-forward/fast-reverse: [◀◀◀], [▶▶▶]
  - \*Pause: [▶||]
- See "CD/MP3/WMA Operations" (pages 12-14) for details.
- After a Podcast file has completed playback, the pause display, or the track-end position Play-Time display will appear. At that time, select a music file once again.

## Setting iPod simple mode

Use this function if you wish to operate through your iPod connected to this unit via the USB cable.

\* The factory default setting is "OFF".

1. Press and hold the [DISP] button (1 sec.).
2. Press [◀◀] or [▶▶] to select "S-CTRL".
3. Press the [ROTARY] knob.
4. Turn the [ROTARY] knob to select "ON" or "OFF".
  - **ON:** Operations can be made through your iPod.
  - **OFF:** Operations cannot be made through your iPod.
5. Press and hold the [ROTARY] knob (1 sec.) to store the setting and return to the previous mode.

## Notes:

- When performing iPod operations using simple control mode, make the operations slowly. If repetitive operations are performed too quickly, unforeseen errors may occur.
- When performing iPod operations using simple control mode, please do not operate the iPod and the unit at the same time, otherwise there may be unexpected event happened.
- Some iPod models do not support this function. Consult your nearest Clarion dealer or website to confirm which models do not support this function.

## Other various play functions (in Play mode)

## Notes:

- These functions are not supported when in the iPod menu mode.
- The Random function set on the iPod remains the same after attachment/detachment of the iPod.
- The Repeat function on the iPod will be changed when you connect/disconnect the iPod to the unit.



### ● Repeat play

Play back one track repeatedly.

1. Press the [RPT] button.

### ● Random play

Play all albums within a selected category, in random order. (Corresponds to “Shuffle (Albums)” command on iPod.)

1. Press the [RDM] button.

### ● All random play

Play all tracks within a selected category, in random order. (Corresponds to “Shuffle (Songs)” command on iPod.)

1. Press and hold the [RDM] button (1 sec.).

### ● To cancel play

1. Press the same play button once again.

#### Notes:

- When the repeat play mode is canceled, after playing all tracks within a selected category, playback will begin from the first track in the selected category.
- When playing the last track within a selected category in Random mode, if ACC is switched off then on again, playback will begin from a different track.
- Though the default setting of an iPod is “All Repeat”, the indication on the mode status is not displayed.
- When performing operations using simple control mode, do not set the repeat off on the iPod.

## Selecting category from the iPod menu

1. Press the [BAND] button (1 sec.) to select the iPod menu mode.

The iPod menu categories will be displayed.

#### Notes:

- Repeat and Random mode operations are not supported when in the iPod menu mode.
  - In iPod menu mode, if you press the [◀◀]/[▶▶] button or turn the [ROTARY] knob fast, playback may not be performed.
2. Turn the [ROTARY] knob to select “Music” or “Video”.
  3. Press the [ROTARY] knob.
  4. Turn the [ROTARY] knob to switch between categories.

The iPod menu categories alternate in the following order:

- In the Music mode:  
“PLAYLISTS” ↔ “ARTISTS” ↔  
“ALBUMS” ↔ “SONGS” ↔ “GENRES” ↔  
“COMPOSERS”...
- In the Video mode:  
“MOVIES” ↔ “MUSIC VIDEOS” ↔  
“TV SHOWS” ↔ “VIDEO PODCASTS” ↔  
“RENTALS”

#### Notes:

The iPod menu mode can be canceled by performing one of the following operations:

- Press the [BAND] button.
  - When the category select screen is displayed, press the [ROTARY] knob.
5. Press the [ROTARY] knob to select the category.
  6. When the track name display is showing, press the [ROTARY] knob.  
Playback will begin from the first track in the selected category, and the iPod menu mode will be canceled.  
\* Subfolders may be displayed, depending on the category.  
In this case, turn the [ROTARY] knob to switch between subfolders, then press the [ROTARY] knob to select the desired subfolder.  
\* When the track name display is showing, pressing the [◀◀] button will return to the currently playing folder name display.
  7. Turn the [ROTARY] knob to select a track within a category.

## iPod®/iPhone® Operations

### iPod menu alphabet search

This function searches the subfolders for desired alphabetical letters.

1. Press the **[BAND]** button to select the iPod menu mode.
2. Turn the **[ROTARY]** knob to switch between categories.
3. Press the **[ROTARY]** knob.
  - \* Subfolders may be displayed, depending on the category.  
In this case, you can turn the **[ROTARY]** knob to switch between subfolders and press the **[ROTARY]** knob to enter the next subfolder layer.
4. Press and hold the **[ROTARY]** knob (1 sec.).
5. Turn the **[ROTARY]** knob to select the desired letter to search.
6. Press the **[ROTARY]** knob to perform search.
  - \* During search, press the **[ROTARY]** knob to cancel search.
7. Press the **[ROTARY]** knob on the song list to select song.
8. Press the **[▶▶]** button to search next song of the desired letter.

### Selecting category using preset memory

1. Press and hold the **[BAND]** button (1 sec.) to select the iPod menu mode.

The category can be set as follows in the **[DIRECT]** (1-6) buttons.

**[1] : PLAYLISTS**

**[2] : ARTISTS**

**[3] : ALBUMS**

**[4] : SONGS**

**[5] : GENRES**

**[6] : COMPOSERS**

2. Press the desired **[DIRECT]** (1-6) button to select the category.
  - \* Subfolders may be displayed, depending on the category.  
In this case, turn the **[ROTARY]** knob to switch between subfolders, then press the **[ROTARY]** knob to select the desired subfolder.
3. When the track name display is showing, press the **[ROTARY]** knob.  
Playback will begin from the first track in the selected category, and the iPod menu mode will be canceled.

\* Turn the **[ROTARY]** knob to select a track within a category.

### iPod menu list back

After exiting the iPod menu operation mode:

If press the **[BAND]** button, it will return to the previous subfolder list mode.

If press and hold the **[BAND]** button (1 sec.), it will return to the category list mode.

### About title display

This unit supports the display of title information transmitted from a connected iPod.

- Character code information is UTF-8; displayable characters include English alphanumerics, some symbols, and some umlaut characters.
- Unsupported characters will be replaced by asterisks (\*).

# 7. TROUBLESHOOTING

	Problem	Cause	Measure
General	Power does not turn on. (No sound is produced.)	Fuse is blown.	Replace with a fuse of the same amperage. If the fuse blows again, consult your store of purchase.
		Incorrect wiring.	Consult your store of purchase.
	No sound output when operating the unit with amplifiers or power antenna attached.	Power antenna lead is shorted to ground or excessive current is required for remote-on the amplifiers or power antenna.	<ol style="list-style-type: none"> <li>1. Turn the unit off.</li> <li>2. Remove all wires attached to the power antenna lead. Check each wire for a possible short to ground using an ohm meter.</li> <li>3. Turn the unit back on.</li> <li>4. Reconnect each amplifier remote wire to the power antenna lead one by one. If the amplifiers turn off before all wires are attached, use an external relay to provide remote-on voltage (excessive current required).</li> </ol>
	Nothing happens when buttons are pressed.	The microprocessor has malfunctioned due to noise, etc.	Press the reset button for about 2 seconds with a thin rod. If the RESET button is pressed when a disc is loaded, please eject the disc and load it once again before attempting to play it.
	Display is not accurate.		
		Main unit connectors are dirty.	Wipe the dirt off with a soft cloth moistened with cleaning alcohol.
	No sound heard	The speaker protection circuit is operating.	<ol style="list-style-type: none"> <li>1. Turn down sound volume. Function can also be restored by turning the power off and on again. (Speaker volume is reduced automatically when the speaker protection circuit operates).</li> <li>2. If the sound is muted again, consult our service department.</li> </ol>

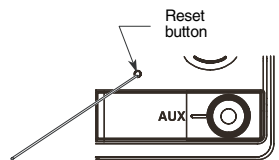

	Problem	Cause	Measure
CD/MP3/WMA	No sound heard	MP3/WMA files are absent in a disc.	Write MP3/WMA files onto the disc properly.
		Files are not recognized as an MP3/WMA file.	Use MP3/WMA files encoded properly.
		File system is not correct.	Use ISO9660 level 1, 2 or JOLIET or Romeo or APPLE ISO file system.
	Sound skips or is noisy.	Compact disc is dirty.	Clean the compact disc with a soft cloth.
		Compact disc is heavily scratched or warped.	Replace with a compact disc with no scratches.
	Sound is cut or skipped. Noise is generated or noise is mixed with sound.	MP3/WMA files are not encoded properly.	Use MP3/WMA files encoded properly.
	Sound is bad directly after power is turned on.	Water droplets may form on the internal lens when the car is parked in a humid place.	Let dry for about 1 hour with the power on.
Wrong filename	File system is not correct.	Use ISO9660 level 1, 2 or JOLIET or Romeo or APPLE ISO file system.	
USB/iPod	No sound heard	The device contains no MP3/WMA files.	Record MP3/WMA files properly to the device.
		The files are not proper MP3/WMA format.	Use only properly encoded MP3/WMA files.
		Connectors are loose.	Disconnect the device and reconnect securely.
		Some USB portable music players may consume current that exceeds the USB rating. In this case, this unit's overcurrent protection circuit operates to stop the music playback.	Check operation of portable music player.
	Sound is interrupted or has noise.	The MP3/WMA files are improperly encoded.	Use only properly encoded MP3/WMA files.
	The device isn't recognized.	The device is damaged.	Disconnect the device and reconnect. If the device is still not recognized, try replacing with a different device.
		Connectors are loose.	
	According to the state of operation on the device, the communication fault is caused.	Disconnect the device and reconnect.	
Can't insert the device.	The device has been inserted improperly.	Try reversing the connection direction of the device (usually the brand name surface should be facing left).	
	The connector is broken.	Replace with a new device.	

## 8. ERROR DISPLAYS

If an error occurs, one of the following displays is displayed.

Take the measures described below to eliminate the problem.

	Error Display	Cause	Measure
CD/MP3/WMA	<b>ERROR 2</b>	A CD is caught inside the CD deck and is not ejected.	This is a failure of CD deck's mechanism and consult your store of purchase.
	<b>ERROR 3</b>	A CD cannot be played due to scratches, etc.	Replace with a non-scratched, non-warped-disc.
	<b>ERROR 6</b>	A CD is loaded upside-down inside the CD deck and does not play.	Eject the disc then reload it properly.
USB/iPod	<b>ERROR 7 (iPod mode)</b>	The connected iPod is not recognized.	Disconnect and reconnect the iPod.
	<b>ERROR 7</b>	Overcurrent detection.	Disconnect the devices and reconnect. If the devices are still not recognized, try replacing with a different devices.
	<b>ERROR 7</b>	Do not support the HUB devices.	Do not use the HUB devices.

If an error display other than the ones described above appears, press the reset button. If the problem persists, turn off the power and consult your store of purchase.

# 9. SPECIFICATIONS

## **FM Tuner**

Frequency Range: 87.5 MHz to 108.0 MHz  
 Usable Sensitivity: 11 dB $\mu$ V  
 50dB Quieting Sensitivity: 17 dB $\mu$ V  
 Alternate Channel Selectivity: 60 dB  
 Stereo Separation (1 kHz): 30 dB  
 Frequency Response ( $\pm 3$  dB): 30 Hz to 15 kHz

## **AM Tuner**

Frequency Range: 531 kHz to 1629 kHz  
 Usable Sensitivity: 28 dB $\mu$ V

## **CD Player**

System: Compact disc digital audio system  
 Usable Discs: Compact disc  
 Frequency Response ( $\pm 1$  dB): 20 Hz to 20 kHz  
 Signal to Noise Ratio (1 kHz): 100 dB  
 Dynamic Range (1 kHz): 80 dB  
 Harmonic Distortion: 0.03%

## **Bluetooth**

Specification: Bluetooth Ver. 2.0+EDR

Profile:

HSP (Headset Profile)  
 PBAP (Phone Book Access Profile)  
 HFP (Hands-Free Profile)  
 OPP (Object Push Profile) Phone Book  
 A2DP (Advanced Audio Distribution Profile)  
 AVRCP (Audio/Video Remote Control Profile)  
 Send/Receive Sensitivity: Class 2

### **Note:**

- Specifications and design are subject to change without notice for further improvement.

## **Audio**

Maximum Power Output: 200 W (50 W  $\times$  4 ch)  
 Continuous Average power Output:  
 22 W  $\times$  4, into 4 ohm, 20 Hz to 20 kHz,  
 1% THD  
 Bass Control Action (100 Hz): +14 dB, -14 dB  
 Treble Control Action (10 kHz): +14 dB, -14 dB  
 Line Output Level (CD 1 kHz): 2 V

## **General**

Power Supply Voltage:  
 14.4 V DC (10.8 to 15.6 V allowable), negative ground  
 Current Consumption: Less than 15 A  
 Speaker Impedance: 4  $\Omega$  (4  $\Omega$  to 8  $\Omega$  allowable)  
 Auto Antenna Rated Current: 500 mA or less  
 Weight / Source unit: 1.51 kg  
 Dimensions / Source unit:  
 178 (W)  $\times$  100 (H)  $\times$  155 (D) mm

# Clarion Co., Ltd.

---

All Rights Reserved. Copyright © 2011: Clarion Co., Ltd.  
Printed in China / 中国印刷 / 중국에서 인쇄

2011/01

**PE-3402K**  
**280-8992-00**