

clarion®

Owner's manual

OHM107VD

10.2" TFT LCD Roof Mount Monitor with DVD Player

1 . CONTENTS

1.	Key Product Features	2
	Safety Information	3
2.	DVD Video Features	4
	Controls and Functions	5
	Controls and Functions : Remote Unit.....	6
3.	Operations	8
	System Setup	11
	Using the OSD Menu	11
	Customising DVD Settings	12
	Maintenance.....	13
4.	Troubleshooting	14
5.	Specifications	15
6.	Installation	16
	Wiring and connections.....	16
	Installing the player.....	17
	Installing the remote control battery	18
	Notes	19

Welcome

Thank you for buying the Clarion OHM107VD Roof Mount LCD Monitor with DVD player. Please read this manual carefully before using this product in order to get the most out the features and functions. We suggest you keep this manual in a safe place, as it can be a valuable tool in helping you to understand all of the features and functions of your multimedia system.

Key Product Features

The OHM107VD is a Roof Mounted 10.2" TFT-LCD Monitor and DVD player that can be used stand-alone or integrated into a mobile multimedia system.

The OHM107VD has the following features:

- 10.2" TFT-LCD color monitor (16:9)
- Roof Mounting Application
- Pixel(dots):800RGB(W)x480(H)
- Wide Viewing angle(up/down/left/right):45/55/65/65
- NTSC and PAL Compatible
- Adjustable Color/Contrast/Brightness/Tint
- Manual Viewing Angle Adjustment
- Vertical Adjustable: Up/Down >150
- White LED Dome Light
- Automotive Startup Protection
- Built-in IR Transmitter for IR Wireless Headphone
- IR Remote Control
- On Screen Display
- 2 x AV Input
- 1 x AV Output
- Slot-in DVD mechanism
- Capability to read:
 - DVD Format: DVD±R/DVD±RW and
 - CD Format: CD-DA/CD-RW/MP3/VCD/SVCD

Note: Multi-session CDs and 320kbps WMA files cannot be played on this player.

CAUTION

- Do not operate this product in any way other than described within this Owners Manual. Failure to follow the instructions within it will invalidate your warranty.
- **SAFETY FIRST!** Do not install the display where it may (i) obstruct the driver's vision, (ii) impair the performance of any of the vehicle's operating systems or safety features, including airbags, or (iii) impair the driver's ability to safely operate the vehicle.
- When using the system, make sure you are firmly secured by your seat belt to ensure you do not accidentally hit your head on the screen during sudden braking or other incidents. If you are ever in an accident, injuries can be more severe if the seat belt is not properly buckled.
- Installation or servicing of this product by persons without training and experience in electronic equipment and automotive accessories may be dangerous. Visit www.clarion.com.au for your nearest Authorised Clarion Dealer for professional installation.
- To avoid draining the battery it is suggested that you not use this product for extended periods without the vehicle engine running.
- Do not disassemble or alter this product in any way. Failure to observe this warning can cause damage to the unit and void the warranty.
- Never clean the surface of the screen with a chemical solvent or a corrosive detergent. Doing so may cause permanent damage to the TFT LCD screen.
- Avoid installing this product under direct sunlight or near a hot air vent. Please note that its normal working temperature is from -5°C to +50°C. If the internal temperature of the vehicle is extremely high, a short cooling down period is necessary before operating the product.
- If the temperature inside the car is very low and the monitor is used soon after switching on the heater, moisture may form on the TFT LCD panel. Turn off the unit immediately! Failure to do so may cause the internal components to short. Allow the unit to rest to allow the condensation to disappear before you continue operation.
- In extremely cold temperatures, the movement of the picture may be slow and the image may appear dark. This is not a malfunction and normal function will resume once the TFT LCD reaches its operating temperature range.
- Do not drop or hit the TFT LCD panel with a hard object, as it may cause permanent damage. Should the TFT LCD panel break, avoid touching the glass and/or fluid. If you injure yourself as a result of such contact clean the wound with plenty of water and seek immediate medical attention.
- Due to different vehicle specifications, please kindly ensure that the display monitor is properly located and not obstructing the air-conditioning vent.
- Avoid inserting any foreign objects into the slot of the disc player. Failure to observe this may void your warranty and cause damage to the mechanism of this unit.
- Protect your disc!. When you leave the car, be sure to eject any disc from this unit and store it away from direct sun light.
- Heat and humidity may warp, damage or erase your discs and you may not be able to play them again.
- Use the supplied screws to fix the OHM107VD Metal Mounting Plate.

2 . DVD VIDEO FEATURES

This unit provides the following functions in addition to high image quality and sound quality of DVD video:

Multi-sound Function

DVD audio can store up to 8 languages for one film. This allows for the selection of language of ones preference.

Multi-angle Function

A DVD video that is filmed from multiple angles and offers you the choice to select whichever one you wish, to view a scene from different perspectives.

Subtitle Function

A DVD video can offer you a choice of up to 32 subtitles languages.

Disc Playback

This DVD player can play the following formats.



DVD's 12cm



VCD's 12cm



Audio CD'S 12cm



MP3 CD'S 12cm

About CD Extra discs

A CD Extra disc is a disc in which a total of two sessions have been recorded. The first session is Audio session and the second session is the Data session. Your personally-created CDs with more than 2 data sessions recorded cannot be played on this DVD Video Player.

MP3 Playback

This unit can play back CD-R/CD-RW discs on which MP3 music data have been recorded.

Region Numbers

The DVD Video System assigns a region number to DVD video player and DVD disk by Sales area. The DVD video region number is marked on the disk Jacket as shown below.

Example :  

Controls and Functions

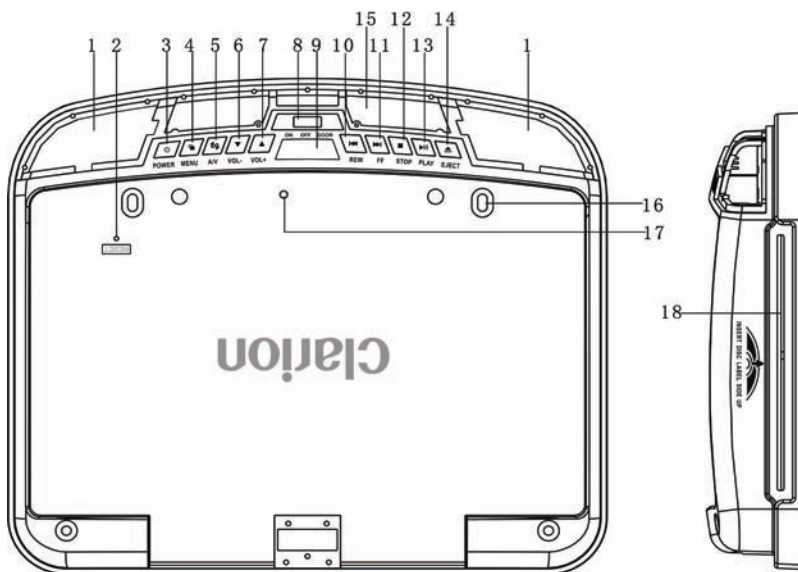

Item	Name	Function or Control
1	Dome Light	Provides an interior light for the vehicle.
2	Reset Button	Press with a pencil or other narrow-tipped tool to reset the player.
3	Power Button	Press to turn on or turn off the player
4	Menu Button	Press to open the Display menu. Press again to sequentially select each menu item.
5	AV Input Source Button	Press to select the desired Video Input Mode. (DVD-IN, AV IN1 and AV IN2).
6	(VOL-) Button	Press to reduce a value in the menu (such as decreasing the volume).
7	(VOL+) Button	Press to increase a value in the menu (such as increasing the volume).
8	Dome Light switch	Slide the switch to select the light ON, OFF or DOOR activated. See note below. ▲
9	Panel Open Button	Press to open the LCD panel.
10	⏮ Button	Press to skip the previous chapter on DVD or track on CD; Press and hold it to fast reverse playback at 2x, 4x, 8x, 16x and 32x speeds.
11	⏭ Button	Press to skip the next chapter on DVD or track on CD; Press and hold it to fast forward playback at 2x, 4x, 8x, 16x and 32x speeds
12	Stop button	Press to stop playback, press [PLAY] or [ENTER] button to start playing at the last position; Press [STOP] button twice to fully stop playback, Press [PLAY] or [ENTER] button to start playing at the beginning of DVD.
13	Play or Pause ▶	Press to Play or Pause a disc.
14	Eject button	Press to Eject the disc.
15	IR window	Receives IR signals from the remote control and sends IR signals to IR wireless headphone.
16	Fixing holes	Connect the player to the mounting plate with screws inserted into these holes.
17	LCD Shut Off switch	Press to turn off the LCD screen
18	Disc slot	Insert the disc into this slot.

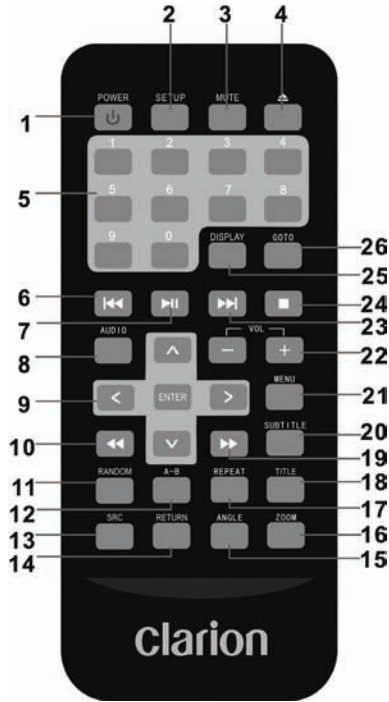

▲ This function can be operational only when the green wire of the dome light is connected to the door sensor and the polarity switch is set to the correct position (Refer Page 16). Please refer to the vehicle's wiring manual for the correct connection details.

Controls and Functions : Remote Unit



Item	Name	Function or control
1	Power	Press to turn the OHM107VD On or Off.
2	Setup	Press to access the setup menu to modify the DVD player settings.
3	Mute	Press to turn the Sound On or Off.
4	Eject	Press to Eject the disc.
5	0-9	Press to enter Track Numbers directly or for changing some settings.
6	Previous	Press to go to the Previous Chapter on DVD or Track on CD.
7	Play or Pause	Press to Play or Pause the CD or DVD.
8	Audio	DVD: Press to change the Audio Language during DVD playback. VCD/CD: Press to change the Audio Channel (Left, Right, Stereo) during VCD / CD playback.
9	Arrows and ENTER buttons	Press to navigate in a DVD Menu and change setting values in the Display Menu.
10	Skip back	Press to Fast Reverse playback at 2x, 4x, 8x, 16x and 32x speeds.
11	Random	Press to play chapters or tracks in random order.
12	A-B	Press to repeat playback from point A to point B.
13	SRC	Press to select the desired Video Input Mode (DVD-IN, AV IN1 and AV IN2).
14	Return	Press to return the main menu, press again to return the last position of playback.

Controls and Functions : Remote Unit

Item	Name	Function or control
15	Angle	Press to select a different filming Angle. Please note that this feature only works if the DVD is recorded with multiple angles.
16	Zoom	Press to set the Zoom for movie viewing.
17	Repeat	DVD Repeat: Press 1x Chapter, 2x Title, 3x All. CD Repeat: Press 1x Track, 2x All.
18	Title	Press to view the DVD disc's Title Menu.
19	 Skip forward	Press to Fast Forward playback at 2x, 4x, 8x, 16x and 32x speeds.
20	Subtitle	Press to select and turn on DVD Subtitles during playback.
21	Menu	Press to view the DVD Main Menu. Press and hold it to display the Display Menu.
22	VOL - / VOL+	Press to Decrease / Increase the volume.
23	 Next	Press to go to the next Chapter on DVD or Track on CD.
24	 Stop	Press to stop playback, press [PLAY] or [ENTER] button to start playing at the last position; Press [STOP] button twice to fully stop playback, Press [PLAY] or [ENTER] button to start playing at the beginning of DVD.
25	Display	Press to Display the Playback Information- (Title, Chapter, Track and Time).
26	Go To	Press to Start Playback at a selected Chapter, Track or Time.

3 . OPERATIONS

Basic DVD Operation

To open the DVD player

1. Press Open Button to unlock the LCD panel.

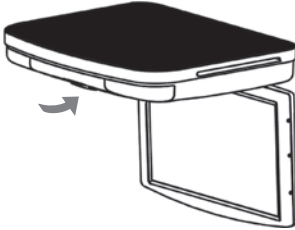

2. Swing the monitor downward to the desired angle. Note : The LCD display opens to a maximum angle of 150° degrees. Do not attempt to open it further.

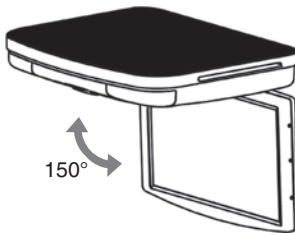

To close the DVD player, swing the LCD panel upward until you hear the lock click.

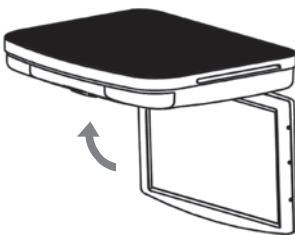

⚠ Make sure that cords and other items do not get caught in the panel when you close it. For your safety, be sure to close the LCD panel when not use it.

Turning on the player

Press the [] button on the remote control or on the front panel. The player turns on and the

input source and format are displayed in the top left hand corner of the screen:



Notes: 1. The default source is DVD-IN.
2. If the message "NO DISC" is displayed on the screen, insert disc media or press SRC button to change input source.

Selecting the Input Source

1. When power is ON, press SRC button to switch from one mode to another.
2. The operating modes changes in the following order : DVD-IN > AV1 > AV2 > DVD-IN
Note: DVD disc cannot be inserted if product switched to AV mode.

Turning Off The Player



Press the [] button again to turn the player off. If there is a disc media in the player, it will continue playback from last position the next time you turn the player on. Note: Disc cannot be ejected if player is switched off.

Playing a Disc

1. If the input source isn't already set to DVD-IN, press SRC button to change the input source to DVD-IN

2. Insert a disc to DVD into the disc slot on the right of the player. After several seconds, the screen displays a "loading" message.

3. Press Play/Pause button or ENTER button.

- To stop playback, press STOP button.
- To play the previous track or chapter, press "Previous Chapter" button 
- To play the next track or chapter, press "Next Chapter" button 
- To pause or resume playback, press the Play/Pause button 

4. Press Eject button to eject the disc from the player 

5. Press Power button to turn off the player []

Basic DVD Operation

Playing a Disc (Notes)

- When DVD Playback is interrupted by switching the product OFF; when it is switched ON again the DVD commences playback from the start of the disc.
- If during DVD playback, the STOP button is pressed and then the PLAY button is pressed, the DVD will recommence playback from the beginning of the last chapter played.

Muting the sound

1. Press MUTE button to mute the sound during disc playback.
2. Press MUTE button again to enable sound.

Playing DVD's

Accessing the DVD root menu

- Press MENU button during playback to display the menu. A DVD is divided into sections called titles and chapters. When you play a DVD, a root menu of the disc appears on the screen of your Monitor. The contents of the menu vary from disc to disc. Press MENU during playback to display the menu again. Some DVDs only allow you to select disc playback options using the DVD root menu.

Displaying Playback Information

During the playback, press DISPLAY button continuously to show the following:

TITLE ELAPSED			CHAPTER ELAPSED		
TT 01/04	CH/25	0:02:10	TT 01/04	CH/25	0:03:40
TITLE REMAIN			CHAPTER REMAIN		
TT 01/04	CH/25	0:03:10	TT 01/04	CH/25	0:03:40

Changing the audio language during Playback (Multi Audio)

1. Press AUDIO button to change audio track during DVD playback. The current audio language number, the total number of available audio channels (languages) and current language are displayed.
2. If there are multiple languages are available, press the AUDIO button again to cycle through the available languages. The audio display disappears automatically if AUDIO button is not pressed again within 3 seconds.

Note: Some DVDs only allow access to this function through the DVD menu.

Turning the subtitles and changing the subtitle language on :

1. Press SUBTITLE button to change the subtitle language you want during DVD Playback. The current language number, the total number of the subtitle languages and current language are displayed.
2. If multiple languages are available, press SUBTITLE button again to cycle through the available languages.
3. To turn subtitles off, Press SUBTITLE button until "subtitle off" appears on the screen. The subtitle display disappears automatically if SUBTITLE button is not pressed again within 3 seconds.

Note: Some DVDs only allow access to this function through the DVD menu.

Using Repeat Playback

To repeat a chapter, a title, or both: During playback, press REPEAT repeatedly to cycle through the available settings:

- Chapter---Repeats the current chapter.
- Title---Repeats the current title.
- All---Repeats all chapters and titles.
- Off---Resumes normal playback

To repeat a custom segment:

1. During playback, press A-B to set the starting point "A".
2. Press A-B again to set the ending point "B". The player plays the segment between point A and point B repeatedly.
3. To cancel the repeat playback and resume normal playback, press A-B again.

Changing viewing angle during playback (Multi-Angle)

To change viewing angle:

1. Press ANGLE button to cycle through available viewing angles during DVD playback. The current angle number and the total number of angles available appear on the screen.
2. Press ANGLE button again to select a different angle, then press it again to exit and return to normal viewing angle.

Basic DVD Operation

Changing viewing angle during playback (Multi-Angle)

3. The angle display disappears automatically if the ANGLE button is not pressed again within 3 seconds.

Note: Viewing angles are available for a DVD if the back of the DVD jacket contains a multiple angles icon. 

Using Zoom

To ZOOM the image:
During disc playback, press ZOOM to switch through the available zoom settings. (2x, 3x, 4x, 1/2x, 1/3x, 1/4x and normal)

Note: If it is JPEG disc, press ZOOM, then press FF or FR to select settings.

Playing Audio CD's

To display playing time and the current track:
During CD playback, press DISPLAY button to display, the disc type, current time, current track number and total number of the tracks are displayed on the screen.

To repeat a track or the entire CD:
During playback, press REPEAT repeatedly to cycle through the available settings:

- Track---Repeats the current track.
- All---Repeats the entire CD.
- Off--- Resume normal playback.

To repeat a custom segment:

1. During playback, press A-B to set the starting point "A".
2. Press A-B again to set the ending point "B". The player plays the segment between point A and point B repeatedly.
3. To cancel and resume normal playback, press A-B again.

Playing MP3 CD's

MP3 is a format for storing digital audio. An audio track is compressed into the MP3 format with little loss of audio quality, while taking up much less disc space. This player can play CD-R/RW disc that contain music MP3 files.
When a MP3 disc is inserted into the player, the menu screen appears automatically. You can use the menu screen to select the folders and tracks you want, or the player plays the tracks in the order they were burned onto the disc.





To select the folders and tracks you want:

1. Press DISPLAY to list all the folders, then press up or down button on the remote control to choose a folder from the folder list.



2. Press ENTER button on the remote control, the screen will display the files list of the folder you selected.



3. Press up or down button on the remote control to choose a file from the files list.
4. Press ENTER button on the remote control to play this file.
5. Press the  to move to the next file. Or press the  to move to the previous audio file.

To repeat a file or folder of an MP3 disc:
During MP3 playback, press the REPEAT button to cycle through the settings:

- Repeat single---repeats the current file.
- Repeat all---repeats the contents of current folder.
- Repeat off---turns off repeat and resumes normal playback.

MP3 Icons



This icon in front of an item indicates it's a folder.



This icon in front of an item indicates it's an MP3 file.

System setup

Adjusting the picture response

Accessing the menu :

To adjust the picture, use the menu button to select the features you would like to adjust.

Adjustment selections are as follows.

1. Press and hold MENU button for 3 seconds on the remote control or [] the keypad of the player.



2. Press MENU button repeatedly to select the item you want to change.
3. Press < or > buttons to change the value of the item selected.

The features are:

Contrast: Adjust the contrast of the picture

Brightness: Adjust the brightness of the picture

Color: Adjust the color of the picture

Tint: Adjust the tint of the picture (it is only available in NTSC system)

Wide Screen: Selects display Mode: Wide (16:9)/ Normal (4:3)

LAC Enable: Low angle compensation to correct picture degradation.

Using the OSD Menu

Press SETUP on the remote control and the OSD menu opens.

	Menu	Description
PACKAGE CONTENTS	General setup page	<p>TV DISPLAY: modifies the display if it doesn't match the width to height ratio the DVD uses. You can select from the following:</p> <ul style="list-style-type: none"> -NORMAL/PS -NORMAL/LB -WIDE <p>ANGLE MARK: Selects a different angle if the back of the DVD jacket contains a multiple angles icon. You can select ON or OFF.</p> <p>OSD LANG: Selects a language for DVD play menu. You can select from following:</p> <ul style="list-style-type: none"> -ENGLISH -FRENCH -SPANISH-GERMAN-ITALIAN <p>CAPTIONS: Selects the caption for DVD play. You can select ON or OFF.</p> <p>SCREEN SAVER: Protects the screen if it paused about 5 minutes. You can select ON or OFF.</p>
	Speaker setup page	<p>DOWNMIX: Applies to Dolby digital sound. You can select from following:</p> <ul style="list-style-type: none"> -LT/RT -STEREO
	Speaker setup page	<p>DUAL MONO: Selects the different channels of sound. You can select from following:</p> <ul style="list-style-type: none"> -STEREO -L-MONO -R-MONO -MIX-MONO <p>DYNAMIC: Selects the different rating level of dB. Select from:</p> <ul style="list-style-type: none"> -Off -2/8 -4/8 -6/8 -FULL
	Preference page	<p>TV TYPE: Selects the TV system. You can select from following:</p> <ul style="list-style-type: none"> -PAL (Europe and Asia) -NTSC (United States) <p>Note: Altering this setting will also change the RCA AV Output.</p> <p>AUDIO: Selects the audio track language. You can select from following:</p> <ul style="list-style-type: none"> -ENGLISH-FRENCH-SPANISH-CHINESE -RUSSIAN-THAI <p>SUBTITLE: Selects the language of the subtitles displayed on the screen. You can select from following:</p> <ul style="list-style-type: none"> -ENGLISH-FRENCH-SPANISH-CHINESE -RUSSIAN-THAI -OFF <p>DISC MENU: Selects the language of the current disc. You can select from following:</p> <ul style="list-style-type: none"> -ENGLISH-FRENCH-SPANISH-CHINESE -RUSSIAN-THAI <p>PARENTAL: Restricts the viewing of movies to children of appropriate age levels only. You can select 1 to 8.</p> <p>PASSWORD: Uses the number key "0" to "9" to input 4-digit password. The default password is 3308.</p> <p>DEFAULT: Resets all settings to the factory defaults.</p>

Customizing DVD settings

Using the general setup page:

1. Press **SETUP** button on the remote control.
The DVD setup menu opens.
2. Press **◀** or **▶** to select general setup page, then the list opens.
3. Press the **▼** or **▲** to select the desired setting item. The items include TV DISPLAY, ANGLE MARK, OSD LANG, CAPTIONS and SCREEN SAVER.
4. Press **ENTER** to open the list, then press **▼** or **▲** to choose the setting.
5. Press **ENTER** to confirm.
6. Press **SETUP** to exit the setup menu.

Using the speaker setup page:

1. Press **SETUP** button on the remote control.
The DVD setup menu opens.
2. Press **◀** or **▶** to select speaker setup page, then the list opens.
3. Press **▼** or **▲** to select the desired setting. The items include DOWNMIX, DUAL MONO and DYNAMIC.
4. Press **ENTER** to open the list, then press **▼** or **▲** to choose the values.
5. Press **ENTER** to confirm.
6. Press **SETUP** to exit the setup menu.

Using the preference page:

1. This setting is only available in stop mode or when no disc in the player.
2. Press **SETUP** button on the remote control.
The DVD setup menu opens.
3. Press **▼** or **▲** to select preference page, then the list opens.
4. Press **▼** or **▲** to select the desired setting item. The items include TV TYPE, AUDIO, SUBTITLE, DISC MENU, PARENTAL, PASS WORD and DEFAULT.
5. Press **ENTER** to open the list, then press **▼** or **▲** to choose the setting.
6. Press **ENTER** to confirm.
7. Press **SETUP** to exit the setup menu.

Note:



This icon indicates that it is locked. You can not change the rating (parental control level)



This icon indicates that it is unlocked. You can change the rating (parental control level)

Maintenance

Use only compact discs bearing the  mark.

Do not play heart-shaped, octagonal, or other specially shaped compact discs.

Some CDs recorded in CD-R/CD-RW mode may not be usable.

Handling

- Compared to ordinary music CDs, CD-R and CD-RW discs are both easily affected by high temperature and humidity and some of CD-R and CD-RW discs may not be played. Therefore, do not leave them for a long time in the car.
- New discs may have some roughness around the edges. If such discs are used, the player may not work or the sound may skip. Use a ball-point pen or the like to remove any roughness from the edge of the disc.

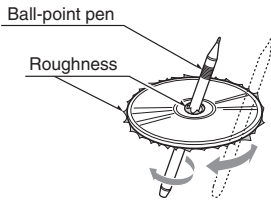

- Never stick labels on the surface of the compact disc or mark the surface with a pencil or pen.
- Never play a compact disc with any cellophane tape or other glue on it or with peeling off marks. If you try to play such a compact disc, you may not be able to get it back out of the CD player or it may damage the CD player.
- Do not use compact discs that have large scratches, are misshapen, cracked, etc. Use of such discs may cause misoperation or damage.
- To remove a compact disc from its storage case, press down on the center of the case and lift the disc out, holding it carefully by the edges.
- Do not use commercially available CD protection sheets or discs equipped with stabilizers, etc. These may damage the disc or cause breakdown of the internal mechanism.

Storage

- Do not expose compact discs to direct sunlight or any heat source.
- Do not expose compact discs to excess humidity or dust.
- Do not expose compact discs to direct heat from heaters.

Cleaning

- To remove fingermarks and dust, use a soft cloth and wipe in a straight line from the center of the compact disc to the circumference.
- Do not use any solvents, such as commercially available cleaners, anti-static spray, or thinner to clean compact discs.
- After using special compact disc cleaner, let the compact disc dry off well before playing it.

LCD Panel Maintenance

- Wipe off any dust gently with a soft, dry cloth.
- The surface is easily scratched; do not rub it with hard objects.

Do not use any chemical solvent, cleaning agent or corrosive detergent to clean away dirt on the surface of the screen.

4 . TROUBLESHOOTING

If operation freezes, the screen goes black or the unit should otherwise not function properly, try turning the unit OFF and back ON. If the unit does not respond, press the reset switch (see page 9) .

Problem	Cause	Solution
Player does not play disc	Disc inserted incorrectly	Reinsert the disc with the label side up (facing the ceiling).
	Disc format is not supported	Check the disc format.
	Disc is dirty or scratched	Clean or replace the disc.
The player suddenly stopped working or the screen went black	Player error	Try turning the player off and on. If the player still doesn't respond, press the reset button.
Player doesn't turn ON	The car ignition (or ACC/Accessory) is off	Insert the key into the ignition and turn it to ACC/Accessory.
	Condensation in the player	Wait for about one hour or until condensation evaporates.
Player operates erratically	Battery needs replacing	Replace the battery.
	Dirty IR window on the Player or remote control	Clean the player's and the remote control's IR windows.
	Loose connections	Check and tighten all connections.
Picture Skips Intermittently	Disc is dirty or scratched	Clean or replace the disc.
Blurred picture	Possible interference. (E.g. high voltage wire, transformer or aircraft etc...)	Move the vehicle away from the interference.
The picture on the screen is dark	The equipment locates at a low temperature area.	This is a characteristic of LCD displays in low temperature, it will restore to normal brightness after starting the display for few minutes.
	Picture is dull / not bright enough	Adjust the brightness setting.
No sound can be heard from the IR wireless headphones.	Headphones are switched off.	Turn on the headphones.
	The battery in the headphone is low.	Replace or recharge the batteries.
	There is object blocking the transmitting module or beyond the effective receiving area.	Remove the blocking object or move back to the receiving area.
Disc cannot be inserted or ejected	Player must not be in AV1 or AV2 mode. Discs are only accepted or ejected in DVD mode.	Press the SRC button to select DVD mode.
	The Car ACC or IGN is OFF.	Turn the IGN key to ACC

5 . SPECIFICATIONS

	Item	Specification
SPECIFICATIONS	Power Source	Vehicle battery (DC +10V ~ +16V)
	Operating Voltage	DC +14V
	Mechanism	Manual Open / Close
	Display Angle	Vertical Adjustable: Up/Down > 150°
	Pixels	800RGB(W)x480(H)
	Viewing angle (up/down/left/right)	45/55/65/65
	Operating Current / Voltage	<2000mA / Typical $V_{DD}=14V$
	Dome Light	2W
	Operation Temperature	-5°C to +50°C
	Storage Temperature	-20°C to +70°C

Note : Specifications and design are subject to change without notice for further improvement.

Package Contents

	Name of parts	Quantity
PACKAGE CONTENTS	Player	1
	IR remote control with battery	1
	IR wireless headphones	2
	AV cable	1
	AAA batteries for IR headphones	4
	ST4.2x16 screw	6
	CM 4x10 screw	4
	Metal mounting plate	1
	User's manual	1
	Rubber gasket	1

▲ Use only the contents of this package to install and use this player. Use of any accessories not provided may result in damage.

6 . INSTALLATION

Note: Do not attempt to install or service your player by yourself. Installation or servicing of the player by persons without training and experience in electronic equipment and automotive accessories may be dangerous and could expose you to the risk of electric shock or product failure.

Wiring and connections

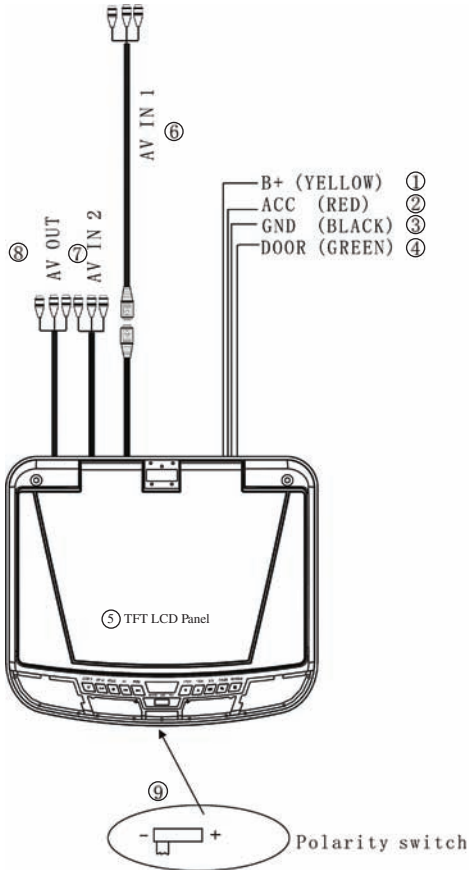

1. Battery + lead (Yellow)

To connect the positive terminal of the car battery.

2. ACC Power Lead (Red)

To ACC power lead powered when engine key position is ACC.

3. Ground Lead (Black)

Connect the lead to a good chassis ground on the car. Make sure the connection is made to

bare metal and is securely fastened using the sheet metal screw provided.

4. Door Lead (Green)

This wire connects the door sensor of car. Then the dome light can be switched by opening or closing door.

5. TFT LCD Panel

Leave protective film on TFT LCD screen until installation is complete.

6. AUX A/V, Input 1

7. AUX A/V, Input 2

8. AUX A/V, Output

An auxiliary A/V output is provided to drive an external monitor. This signal mirrors what's being shown on this player. The volume function does not affect the Auxiliary A/V Output.

9. Polarity switch: Dome Light

Please slide to "-" at the left position if your vehicle's power supply system is negative; Please slide to "+" at the right position if your vehicle's power supply system is positive.

Notes:

1. Please slide it fully to the correct polarity side
2. Do not slide this switch while your player is ON. This may result in damage.

Installing the player

1. Identify what the polarity the vehicle Dome Light circuit is. * Refer to section 6 : "9. Polarity Switch" on Page 16 and set this switch correctly.

2. To prevent short circuits, remove the key from the ignition and disconnect the terminal of battery.

3. Disconnect the original dome light.

4. Attach the metal mounting plate to the roof Using the ST4.2*16 screws.

Note: Do not to cover the original dome light opening.

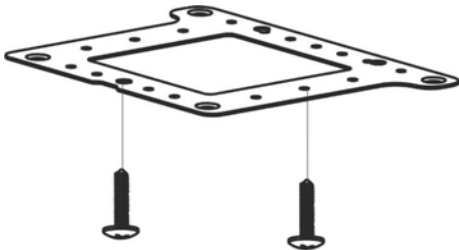

5. Pull out the original dome light Power wire and signal/power cable through the original dome light opening.

6. Place the rubber on the player surround

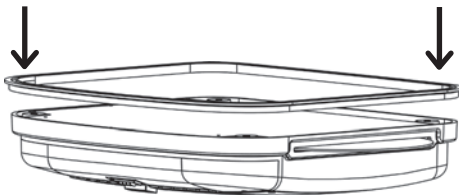

7. Connect input and output cables.

8. Connect the wire harness in the following order: Ground wire (Black), Battery wire (Yellow), +ACC wire (Red) and Door wire (Green).

9. Attach the DVD player to the metal mounting plate using the CM 4x10 screws.

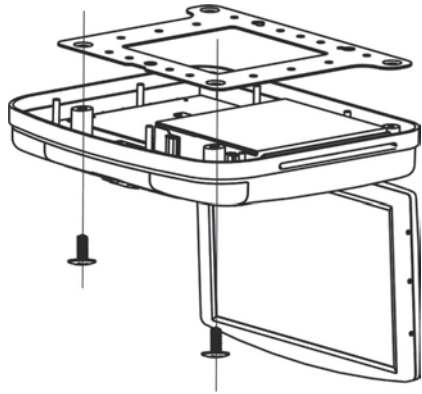

10. Reconnect the terminal of the battery.

Notes:

- Remember to connect the red wire to the ACC of the ignition switch. Or the battery charge might be drained prematurely.
 - If the fuse is opened, first make sure that the cables have not caused a short circuit, and then replace the old fuse with a new one of the same ratings.
 - Do not have unconnected cables or terminals touch the metal on the car or any other conducting material.
 - To prevent short circuits, do not remove the caps from unused terminals or from the ends of the unconnected cables.
 - After the display unit is installed, check and make sure the brake lights, blinkers, wiper, etc. on the vehicle are working properly.
 - Insulate unconnected wires with vinyl tape or other similar material.
 - Make sure that cords and other items do not get caught in the panel when you close it.
- For your safety, be sure to close the LCD panel when not use it.

Installing remote control battery

1. Pull out the battery holder.

Follow the arrow 1 slide it to the right toward the battery while at the same time pull the battery holder away from the remote control.

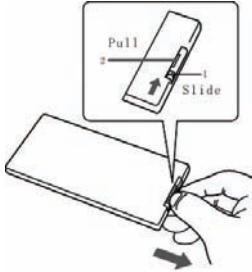

2. Place the battery.

Place the new lithium battery with the (+) side up. (The type of battery: CR2025)

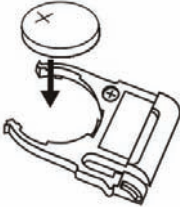

3. Push the holder back.

Using the finger to push in the holder back until the locking sound is heard.

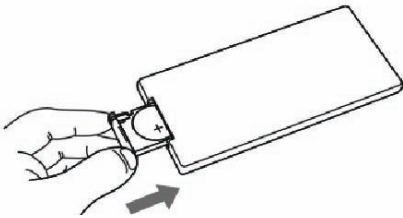

4. Aim the IR Remote Control directly at the DVD player, then press any button to operate.

Notes:

- Use the remote control only inside the vehicle. Tinted windows will effect the signal of the remote controls transmission.
- Useable range of the IR Remote Control is approx. 3 meters.
- Direct sunlight or very bright light reduces sensitivity of the remote control receiver. Be sure the player is not located in direct sunlight.
- Any obstruction between the remote sensor and remote control may disrupt reception.

Clarion Co., Ltd.

All Rights Reserved. Copyright 2007: Clarion Co., Ltd.
Printed in China / www.clarion.com