

clarion®

MULTIMEDIA OWNER'S MANUAL

VX506AU

SUZUKI EDITION WITH NX606AU NAVIGATION MAP



SUZUKI

1. FEATURES	3
Expanding Systems	3
2. PRECAUTIONS	4
3. CAUTIONS ON HANDLING	7
Operation Panel	7
USB Port	7
Cleaning	7
Handling Discs	8
4. OPERATION PANEL	10
Functions of Buttons.....	10
5. REMOTE CONTROL	11
Remote Control Functions	12
6. MAIN MENU	14
7. DVD VIDEO PLAYER OPERATIONS	15
Discs	15
Change DVD System Settings	16
Watching to a Disc.....	16
Showing DVD Player Mode Screen	17
Operate the DVD Player Menu.....	17
Showing Video Files Player Mode Screen	18
Operate the Video Files Player Menu	19
Playable Video Disc Formats.....	19
8. CD PLAYER OPERATIONS	21
Listening to a Disc/Ejecting a Disc	21
Showing CD Player Mode Screen	21
Operate the CD Player Menu.....	21
Listening to Compressed Audio	22
Tag Display Function	22
Playback MP3/WMA/AAC menu	23
9. USB AUDIO OPERATIONS	24
Notes on Using USB Memories.....	24
Select USB Audio Mode	24
Playing Audio Files in USB Memory	25
10. USB VIDEO OPERATIONS	26
Notes on Using USB Memories.....	26
Select USB Video Mode	26
Playing Video Files in USB Memory	26
Playable Video Format.....	26
11. iPod OPERATIONS	28
Notes on Using iPod/iPhone.....	28
iPod Audio Menu Operations.....	28
iPod Audio ID3 Mode Screen	28
iPod Audio Playlist Mode Screen	29
iPod Audio List Mode Screen	29
iPod Audio Simple Control Mode Screen.....	30
iPod Video Menu Operations.....	30
iPod Video ID3 Mode Screen.....	30
iPod Video List Mode Screen	31
iPod Video Simple Control Mode Screen	31
iPod Video Play Mode Screen	31
iPod Audio Bluetooth Mode.....	32

12. Pandora® OPERATIONS	33
Selecting the Pandora Mode	33
Pandora Bluetooth Mode.....	34
13. Bluetooth AUDIO PLAYER OPERATIONS.....	35
Selecting the Bluetooth Audio Mode.....	35
Bluetooth Audio Player Settings.....	35
Registering Your Bluetooth Audio Player (Pairing)	35
Selecting the Bluetooth Audio Player	36
Controlling the Bluetooth Audio Player.....	36
14. Bluetooth TELEPHONE OPERATIONS	37
Select the BT Phone Mode.....	37
Bluetooth Telephone Settings	37
Registering Your Cellular Phone (Pairing).....	38
Select the Cellular Phone.....	38
Get the Phone Book Data.....	38
Telephone Operations	38
Using Siri Eyes Free Function.....	40
15. TUNER OPERATIONS.....	41
16. HDMI MODE	42
Wire Connection of HDMI Mode.....	42
Select HDMI Source	43
17. AUX	44
18. CAMERA INPUT OPERATIONS	44
19. REAR SOURCE OPERATIONS.....	45
DVD Video in Rear	45
DVD Video Rear Source Control Info Mode.	45
DVD Video Rear Source Control Direct Mode.	45
iPod Video Rear Source Control Play Mode.....	46
iPod Video Rear Source ID3 Mode.....	46
20. SETTING OPERATIONS.....	47
General Setup Menu	47
Video Setup Menu	47
Audio Setup Menu	48
Navigation Setup Menu	48
Others Setup Menu.....	48
Set the Anti-Theft Code	49
21. TROUBLESHOOTING	50
General.....	50
DVD Player.....	50
USB Device.....	51
Bluetooth	51
TFT Screen.....	52
22. ERROR DISPLAY.....	53
DVD Player.....	53
23. SPECIFICATIONS.....	54
24. WIRE CONNECTION GUIDE.....	56

1. FEATURES

- **FLAC (Free Lossless Audio Codec) Compatible with ID3-TAG Display**
- **Built-in Bluetooth® Handsfree (HFP) and Audio Streaming (A2DP & AVRCP)**
- **Front-Panel Auxiliary Input and 6ch RCA Output with Subwoofer Control**

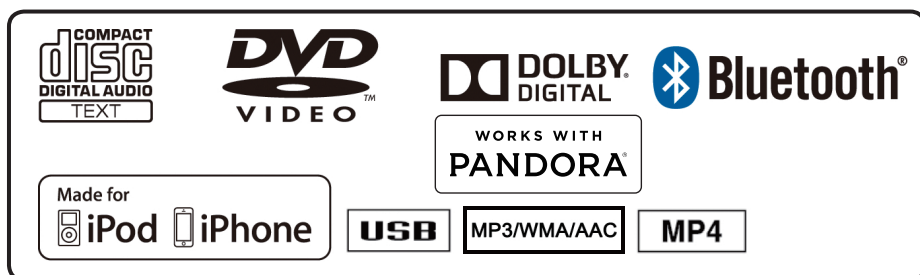

Expanding Systems

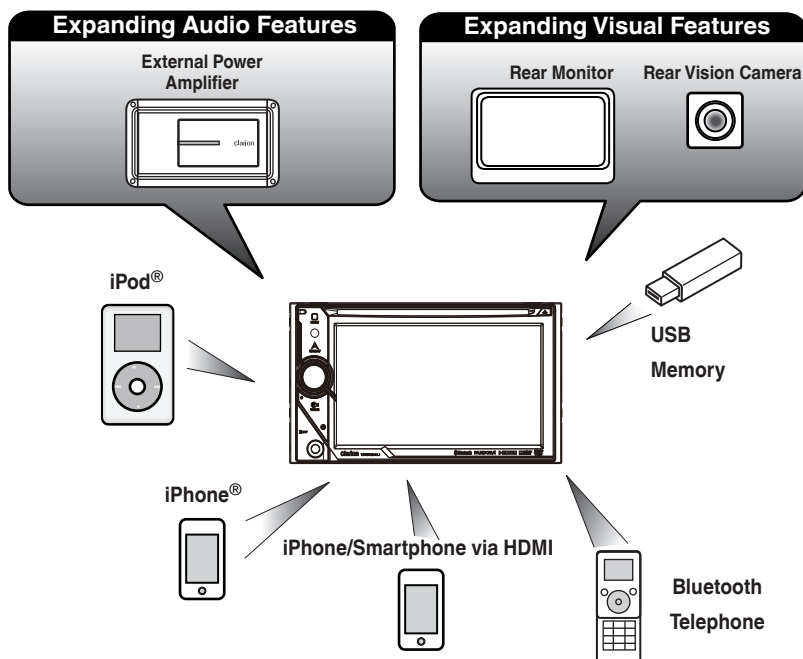

NOTE:

- *The items listed outside of the frames are the commercial products generally sold.*

2. PRECAUTIONS

WARNING

- For your safety, the driver should not watch any video sources and/or operate the controls while driving. Please note that watching and operating any video sources while driving are prohibited by law in some countries. Also, while driving, keep the volume to a level at which external sounds can be heard.
- Do not disassemble or modify this unit. It may cause an accident, fire, or electric shock.
- Do not use this unit when a trouble exists, such as no screen content appears or no sound is audible. It may cause an accident, fire, or electric shock. For that case, consult your authorized dealer or a nearest Clarion service center.
- In case of a problem, such as any material has been entered in the unit, the unit gets wet, or smoke or strange smells come out of the unit, etc., stop using this unit immediately, and consult your authorized dealer or a nearest Clarion service center. Using it in that condition may cause an accident, fire, or electric shock.
- Use a fuse with the same specification only when replacing the fuse. Using a fuse with a different specification may cause a fire.
- For the installation of this unit or a change in the installation, ask your authorized dealer or a nearest Clarion service center for safety. Professional skills and experiences are required to do so.
- This navigation system should not be used to replace your own judgment. No itinerary suggested by this navigation system should ever override any highway regulations, your own judgment, or a knowledge of safe driving practices. Do not follow the navigation system's suggested itinerary if it would cause you to perform a dangerous or illegal act, place you in a dangerous situation, or take you into an area you consider unsafe.
- The advice provided by the navigation system is to be regarded as a suggestion only. There may be times when the navigation system displays the vehicle's location incorrectly, fails to suggest the shortest route, or fails to direct you to your desired destination. In such instances, rely on your own driving judgment, taking into account the driving conditions at the time.
- Do not use the navigation system to locate emergency services. The database does not contain a complete listing of emergency services such as police stations, fire halls, hospitals and walk-in clinics. Please show discretion and ask for directions in such instances.
- As the driver, you alone are responsible for your driving safety.
- In order to avoid a traffic accident, do not operate the system while driving.
- In order to avoid a traffic accident, operate the system only when the vehicle is stopped at a safe place and the parking brake is on.
- In order to avoid a traffic accident or traffic offense, remember that actual road conditions and traffic regulations take precedence over the information contained on the navigation system.
- The software may contain inaccurate or incomplete information due to the passage of time, changing circumstances, and the sources of information used. Please respect current traffic conditions and regulations at all times while driving.
- Where actual road conditions and highway regulations differ from the information contained on the navigation system, abide by the highway regulations.
- Keep the amount of time spent viewing the screen while driving to a strict minimum.
- The navigation system does not provide, nor represent in any way information on: traffic and highway regulations; technical aspects of the vehicle including weight, height, width, load and

speed limits; road conditions including grade, percentage of incline and surface conditions; obstacles such as the height and width of bridges and tunnels; and other current driving or road conditions. Always rely on your own judgment when driving a car, taking into account current driving conditions.

- Changes or modifications not expressly approved by the party responsible for compliance could void the user's authority to operate the equipment.

This equipment has been tested and found to comply with the limits for a Class B digital device, pursuant to Part 15 of the FCC Rules. These limits are designed to provide reasonable protection against harmful interference in a residential installation. This equipment generates, uses and can radiate radio frequency energy and, if not installed and used in accordance with the instructions, may cause harmful interference to radio communications. However, there is no guarantee that interference will not occur in a particular installation.

If this equipment does cause harmful interference to radio or television reception, which can be determined by turning the equipment off and on, the user is encouraged to try to correct the interference by one or more of the following measures:

- Reorient or relocate the receiving antenna.
- Increase the separation between the equipment and receiver.
- Connect the equipment into an outlet on a circuit different from that to which the receiver is connected.
- Consult the dealer or an experienced radio/TV technician for help.

1. When the inside of the car is very cold and the player is used soon after switching on the heater, moisture may form on the disc (DVD/CD) or the optical parts of the player and proper playback may not be possible. If moisture forms on the disc (DVD/CD), wipe it off with a soft cloth. If moisture forms on the optical parts of the player, do not use the player for about one hour. The condensation will disappear naturally allowing normal operation.

2. Driving on extremely bumpy roads which cause severe vibration may cause the sound to skip.

3. This unit uses a precision mechanism. Even in the event that trouble arises, never open the case, disassemble the unit, or lubricate the rotating parts.

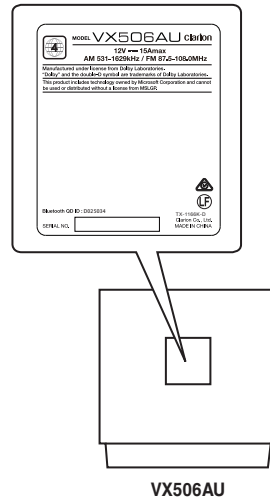

3. CAUTIONS ON HANDLING

Operation Panel

For a longer service life, be sure to read the following cautions.

- The operation panel will operate properly in a temperature range of 0° to 60° C.
- Do not allow any liquids on the set from drinks, umbrellas etc. Doing so may damage the internal circuitry.
- Do not disassemble or modify the set in any way. Doing so may result in damage.
- Subjecting the operation panel to shocks may result in breakage, deformation or other damage.
- Do not let cigarettes burn the display.
- If a problem should occur, have the set inspected at your store of purchase.
- The remote control unit may not work if the remote control sensor is exposed to direct sunlight.
- In extremely cold weather, the display movement may slow down and the display may darken, but this is not a malfunction. The display will work normally when the temperature increases.
- Small black and shiny spots inside the liquid crystal panel are normal for LCD products.

USB Port

- The USB memory sticks must be recognized as "USB mass storage class" to work properly. Some models may not operate correctly.
When the memorized data is lost or damaged by any chance, Clarion shall not be liable for any damage.
When using an USB memory stick, we recommend that you backup your data stored on it before by using a personal computer etc.
- Data files may be broken when using USB memory sticks in the following situation: When disconnecting the USB memory stick or turning the power off during writing or reading data. When affected by static electricity or electric noise. Connect/disconnect the USB memory stick when it is not accessed.
- Connecting with the computer is not supported.
- Connecting with the USB Hub is not supported.

Cleaning

• Cleaning the cabinet

Use a soft, dry cloth and gently wipe off the dirt. For tough dirt, apply some neutral detergent diluted in water to a soft cloth, wipe off the dirt gently, then wipe again with a dry cloth.

Do not use benzene, thinner, car cleaner, etc., as these substances may damage the cabinet or cause the paint to peel. Also, leaving rubber or plastic products in contact with the cabinet

for long periods of time may cause stains.

• Cleaning the liquid crystal panel

The liquid crystal panel tends to collect dust, so wipe it off occasionally with a soft cloth. The surface is easily scratched, so do not rub it with hard objects.

Handling Discs

Handling

- New discs may have some roughness around the edges. If such discs are used, the player may not work or the sound may skip. Use a ball-point pen or the like to remove any roughness from the edge of the disc.

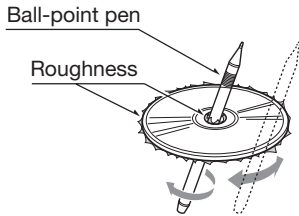

Never stick labels on the surface of the disc or mark the surface with a pencil or pen.

- Never play a disc with any cellophane tape or other glue on it or with peeling off marks. If you try to play such a disc, you may not be able to get it back out of the DVD player or it may damage the DVD player.
- Do not use discs that have large scratches, are misshapen, cracked, etc. Use of such discs may cause misoperation or damage.
- To remove a disc from its storage case, press down on the center of the case and lift the disc out, holding it carefully by the edges.
- Do not use commercially available disc protection sheets or discs equipped with stabilizers, etc. These may damage the disc or cause breakdown of the internal mechanism.

Storage

- Do not expose discs to direct sunlight or any heat source.
- Do not expose discs to excess humidity or dust.
- Do not expose discs to direct heat from heaters.

Cleaning

- To remove fingermarks and dust, use a soft cloth and wipe in a straight line from the center of the disc to the circumference.
- Do not use any solvents, such as commercially available cleaners, anti-static spray, or thinner to clean discs.
- After using special disc cleaner, let the disc dry off well before playing it.

On Discs

- Never turn off the power and remove the unit from the car with a disc loaded.

⚠ CAUTION

For your safety, the driver should not insert or eject a disc while driving.

About the registered marks, etc.

- This product incorporates copyright protection technology that is protected by U.S. patents and other intellectual property rights. Use of this copyright protection technology must be authorized by Rovi Corporation, and is intended for home and other limited viewing uses only unless otherwise authorized by Rovi Corporation. Reverse engineering or disassembly is prohibited.
- Manufactured under license from Dolby Laboratories. "Dolby" and the double-D symbol are trademarks of Dolby Laboratories.
- "Made for iPod" and "Made for iPhone" mean that an electronic accessory has been designed to connect specifically to iPod or iPhone, respectively, and has been certified by the developer to meet Apple performance standards. Apple is not responsible for the operation of this device or its compliance with safety and regulatory standards. Please note that the use of this accessory with iPod or iPhone may affect wireless performance. iPhone, iPod, and Siri are trademarks of Apple Inc., registered in the U.S. and other countries. Lightning is a trademark of Apple Inc.
- Android™ is the trademark of Google Inc.
- The Bluetooth® word mark and logos are registered trademarks owned by Bluetooth SIG, Inc. and any use of such marks by Clarion Co., Ltd. is under license. Other trademarks and trade names are those of their respective owners.
- Pandora, the Pandora logo, and the Pandora trade dress are trademarks or registered trademarks of Pandora Media, Inc. used with permission.

Pandora is only available in certain countries. Please visit <http://www.pandora.com/legal> for more information.

4. OPERATION PANEL

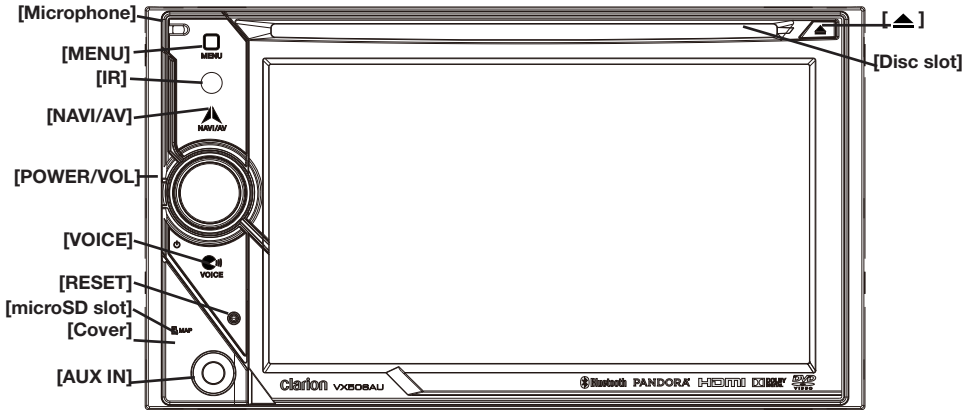

Only navigation map card is available and don't remove it when unit is power on

Functions of Buttons

[POWER/VOL] Knob

- Press this knob to turn on the power.
- When the power is already on, it moves to the Navigation mode. If Navigation mode is displayed, it moves to the Navigation menu.
- Keep pressing this knob more than 2 seconds to turn off the power.
- Turn this knob to left or right to decrease or increase the volume of the system.

[NAVI/AV] Button

- Press this button to display NAVI, press again to return current source.
- Press and hold this button for 2 seconds to display the Dimmer setting menu.

[▲] Button

- Press to eject disc from the unit.

[MENU] Button

- Press this button to display main menu; press again to return current source.
- Press and hold this button for 2 seconds to turn off the monitor. Press any place of the screen to turn on the monitor again.

[RESET] Button

- Press this button to hardware reset the unit.

Note: When the [RESET] button is pressed, frequencies of radio stations, titles, etc. stored in memory are cleared.

[microSD slot]

Note: The microSD card is only for navigation. Please don't insert microSD card for other purpose. After insertion of microSD card for MAP, don't remove it; otherwise, the navigation function will be disabled.

[AUX IN]

AUX 1 Connector.

[Microphone]

This is used for Bluetooth phone.

[IR] SENSOR

- Receiver for the remote control unit (operating range: 30 degree in all directions).

[VOICE] Button

Press and hold this button until you hear the warning tone, then you can use Siri® Eyes Free function.

5. REMOTE CONTROL

RCX005 Remote Control Included

Signal transmitter

Operating range : 30° in all directions

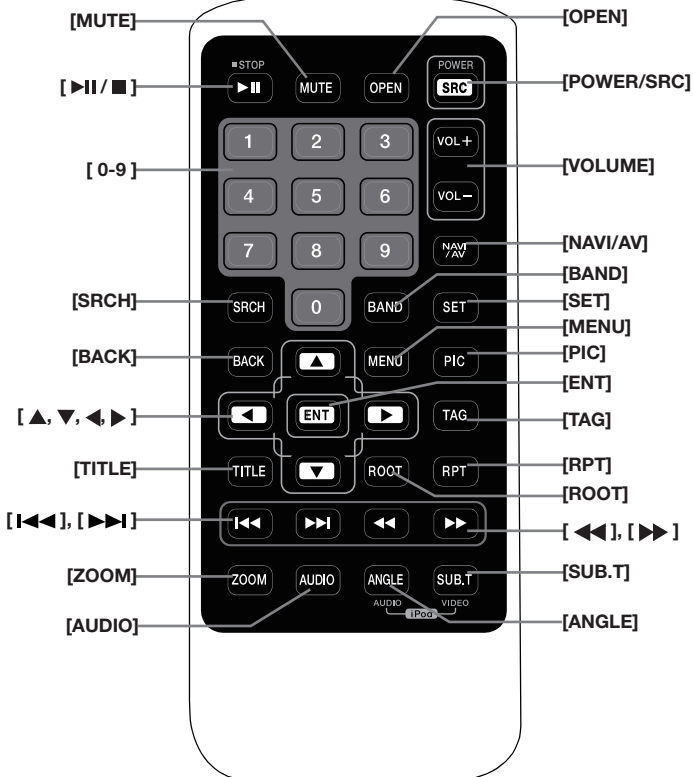

Replacing the batteries

1. Press the retention tab and pull out the battery tray and remove the old battery.
2. Insert the new CR2025 battery and slide the battery tray back in the remote control the same direction that you removed it. Please ensure the tray is inserted in the correct direction.

CAUTION

- Keep the battery out of the reach of children.
Should the battery be swallowed, consult a doctor immediately.
- Batteries (battery pack or batteries installed) must not be exposed to excessive heat such as sunshine, fire or the like.

CAUTION

- Use one CR2025 (3V) lithium battery.
- Remove the battery if the remote control is not used for a month or longer.
- There is a danger of explosion if battery is incorrectly replaced. Replace only with the same or equivalent type.
- Do not handle the battery with metallic tools.
- Do not store the battery with metallic objects.
- If the battery leaks, wipe the remote control completely clean and install a new battery.

- When disposing of used batteries, comply with governmental regulations or environmental public institutions' rules that apply in your country/area.

► Important

- Do not store the remote control in high temperatures or direct sunlight.
- The remote control may not function properly in direct sunlight.
- Do not let the remote control fall onto the floor, where it may become jammed under the brake or accelerator pedal.

Remote Control Functions

You can use the remote control to operate the VX506AU.

Note:

- *The wireless remote control operation may not be optimal in direct sunlight.*

[▶/⏸/■] Button

- Press this button to play or pause video and audio media.
- Press this button more than 1 second to stop video and audio media.

[MUTE] Button

- Mute or Unmute the speaker.
- The symbol  on upper right area of the screen indicates that speaker is muted.

[POWER/SRC] Button

- Press this button to move the focus to next available source item on main menu.
- Press this button to power on when the unit is power off.
- Press this button more than 1 second to power off when the unit is power on.

[0 - 9] Buttons

- Use in the Key Pad screen to select the radio.
- Use to select the track in the track list screen.
- Press to enter DVD video chapters/titles in the Key Pad screen.

[VOLUME] Buttons

- Increase and decrease volume.

[NAVI/AV] Button

- Press this button to switch between current source and current position on navigation map.

[SRCH] Button

- Press this button to open chapter or title search window while playing DVD.

[BAND] Button

- Switch to next band alternately.

[SET] Button

- Press this button to open the Audio setting menu in any mode.

[BACK] Button

- Press this button to quit main menu if current screen is main menu.

[▲], [▼], [◀], [▶] Buttons

- Press this button for cursor movement in main menu or Setting mode.
- From the main menu, you can select your desired source or change your settings.

[MENU] Button

- Press this button to enter the MAIN MENU or return current resource.

[PIC] Button

- Press and hold this button to change your monitor Dimmer.

[ENT] Button

- Press to fix the entered data in the Key Pad screen or enter the item the cursor is on.

[TAG] Button

- No function.

[TITLE] Button

- Press to go to the title menu on the DVD.

[ROOT] Button

- Press to go to the root menu on the DVD.

[RPT] Button

- Press to perform chapter repeat/title repeat/repeat off while playing DVD mode.
- Press to perform Repeat Track/Repeat All while playing CD.
- Press to perform Repeat Track/Repeat Folder/Repeat All while playing MP3/WMA, or video files on disc.
- Press to perform Repeat Track /Repeat Folder/ Repeat All while playing MP3/WMA, or video files in USB memory.

[◀◀], [▶▶] Buttons

- Press to seek the next available lower or higher station in Tuner mode.
- Press to select the next lower or higher chapter number in DVD video mode.
- Press to select the next lower or higher track in CD, USB Video, USB Audio mode.
- Press for movement of background source in Navigation mode.

[◀◀], [▶▶] Buttons

- Press to manually select the next lower or higher station in Tuner modes.
- Press to perform fast-backward or fast-forward searching. Press again to change the speed to 2x, 4x, 8x or 16x.
- Press for movement of background source in Navigation mode.

[ZOOM] Button

- Press to turn on and zoom in while playing DVD. You can zoom in up to 3x. (No all DVD disc supports this function).

[AUDIO] Button

- Press to switch the AUDIO channel of the disc while playing DVD.

[SUB-T] Button

- Press to switch next available subtitle while playing DVD.
- Press to display Video menu in iPod mode.

[ANGLE] Button

- Press to switch the different ANGLE while playing DVD. (No all DVD disc supports this function)
- Press to display Audio menu in iPod mode.

[OPEN] Button

- Press to eject disc from the unit.

6. MAIN MENU

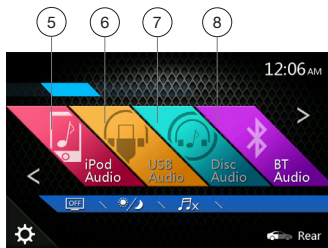

- 1 - Tuner---Touch the button to display the Tuner mode.
- 2 - HDMI---Touch the button to display the HDMI mode.
- 3 - Navi---Touch the button to display the Navigation mode.
- 4 - TEL--- Touch the button to display the Telephone mode.
- 5 - iPod Audio---Touch the button to display the iPod Audio mode.
- 6 - USB Audio---Touch the button to display the USB Audio mode.
- 7 - Disc Audio---Touch the button to display the Disc Audio mode.
- 8 - BT Audio--- Touch the button to display the Bluetooth Audio mode.
- 9 - iPod Video---Touch the button to display the iPod Video mode.
- 10 - USB Video---Touch the button to display the USB Video mode.
- 11 - Disc Video---Touch the button to display the Disc Video mode.
- 12 - Pandora®---Touch the button to display the Pandora mode.
- 13 - Camera---Touch the button to display the Camera mode.
- 14 - AUX1 ---Touch the button to display the AUX1 mode.
- 15 - AUX2 ---Touch the button to display the AUX2 mode.
- 16 - Setting button---Touch the button to display the Setting menu.
- 17 - Monitor off --- Touch the button to turn off the monitor.
- 18 - Day/Night --- Touch the button to change the dimmer.
- 19 - Audio off---Touch the button to make audio source voice off.
- 20 - Rear---Touch the button to display the Rear mode.

Scrolling the menu

Flicking to right or left it will switch to next or previous page of main menu.

Moving the menu position

1. Touch any quadrate icon on main menu more than 2 seconds, the icon will float on main menu.
2. Scrolling the floating icon to any position you want.

7. DVD VIDEO PLAYER OPERATIONS

Discs

Playable discs

This DVD video player can play the following discs.

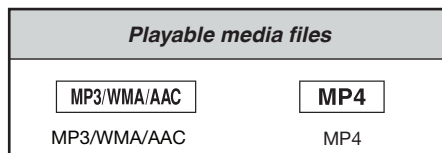
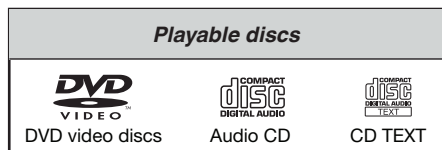

About CD Extra disc

A CD Extra disc is a disc in which a total of two sessions have been recorded. The first session is Audio session and the second session is Data session.

Your personally-created CDs with more than second data sessions recorded cannot be played on this DVD video player.

Note:

- When you play a CD Extra disc, only the first session will be recognized.

Discs that cannot be played back

This DVD video player cannot play back DVD-Audio, DVD-RAM, Photo CDs, etc.

Note:

- It may also not be possible to play back CDs recorded on a CD-R unit and CD-RW unit. (Cause: disc characteristics, cracks, dust/dirt, dust/dirt on player's lens, etc.)
- If a CD-R or CD-RW disc that has not been finalized is played, it will take a long time to start playing. Also, it may not be possible to play depending on its recording conditions.
- You cannot play SuperAudio CD.

The CD player is not supported even if it is a hybrid disc.

About MP3/WMA/AAC playback

This unit can play back CD-R/CD-RW, DVD-R/RW and DVD+R/RW discs on which MP3/WMA/AAC music data have been recorded.

For a detailed information, see the section entitled "Listening to compressed audio".

Note on region numbers

The DVD video system assigns a region number to DVD video players and DVD discs by sales area. DVD video players sold in Australia can play back all DVD discs with the region number "ALL", "4" or any combination of numbers that also incorporate a "4".

The DVD video region number is marked on the disc jacket as shown below.



Change DVD System Settings

Note:

If the setup operation is performed in the middle of DVD video play, the disc will restart from the beginning.

Selecting DVD Setup Menu

1. Touch the **[Settings]** button on the Main Menu to access the Video setup menu.
2. Touch **[Video]** button. The video menu is displayed.

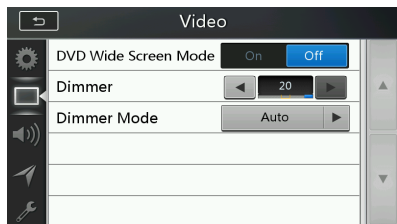

Setting up the Screen Size

Touch the **[DVD Wide Screen Mode]** button to turn on or turn off the DVD wide screen mode.

The factory default setting is "off"

Note: Not all DVD disc support this function.

Setting up the password for parental level control

The factory default pass code is "0000".

1. In Main Menu Touch **[Settings]** button. Touch **[Others]** button on the display. Touch the **[Set Password]** ---- and a numerical key pad will appear.

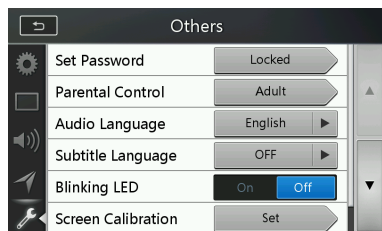

Input a new password and come again. The password is set.

Note:

When a disc with view restrictions is inserted, you will be prompted to input this password. The disc will not be viewable until the correct password is entered.

Set rating for parental level control

1. Select Others screen while in Setting mode. Touch **[Parental Control]** button. Touch the desired rating for level control. Use this table to set the parental level.

Kid Safe	Kid Safe
G	General Audiences
PG	Parental Guidance Suggested
PG-13	Parents Strongly Cautioned
PG-R	Parental Guidance Restricted
R	Restricted
NC-17	No One 17 And Under Admitted
Adult	Only Adult

- The contents that the parental level restricts vary with the country code.

Note: The rating can be selected only under the password unlocked status, and the limits can be set only under the password locked status.

Watching to a Disc

1. To load a disc:

Insert the disc into the center of the insertion slot the label side facing up.

CAUTION

For your safety, the driver should not insert or eject a disc while driving.

Note:

- Never insert foreign objects into the disc insertion slot.
 - If the disc is not inserted easily, there may be another disc in the mechanism or the unit may require service.
 - 8cm (single play) discs cannot be used.
2. Disc starts playing automatically.

WARNING

Some videos may be recorded at higher than desired volume levels. Increase the volume gradually from the minimal setting after the video has started.

Ejecting a disc

1. To eject a disc press eject **[▲]** button. The play mode then switches to the Tuner mode.

If the disc is left in the ejected position for 10 seconds, the disc is automatically reloaded. In this case, the play mode will remain in the Tuner mode.

Note:

If you force a disc into before auto reloading, it may damage a disc.

Showing DVD Player Mode Screen

After disc is loaded, the play mode is automatically engaged.

Touch any place of the screen to display DVD Video menu touch the screen again to return the playback screen. The display will return to the playback screen, if you do not touch the screen for 10 seconds.

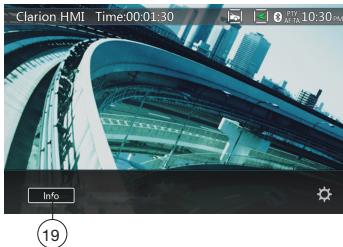
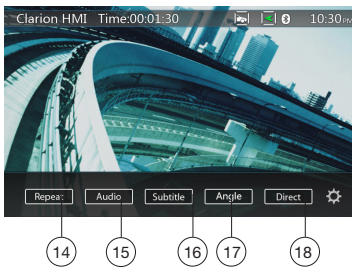

- 1 - Option button
- 2 - Show Cursor keys button
- 3 - Previous Chapter/Fast Backward button
- 4 - Play/Pause button
- 5 - Next Chapter/Fast Forward button
- 6 - Elapsed playing time
- 7 - Seek bar
- 8 - Total time
- 9 - Menu List button
- 10 - System time
- 11 - Bluetooth status indicator

- 12 - DVD playback information
- 13 - Shortcut button
- 14 - Repeat Switching button
- 15 - Audio Channel switching button
- 16 - Subtitle switching button
- 17 - Angle button
- 18 - Direct chapter or title searching button
- 19 - Information button

Operate the DVD Player Menu

You can select the button items displayed in the DVD menu by directly touching it.

Play/Pause Playback

1. Touch [] button to pause during playback.
2. Touch [] button again to resume playback.

Skip (Search) a Chapter

1. Touch [] or [] button during playback. Chapters are skipped down or up from current locations, as many times as the button is touched, and playback starts.

Seek use seek bar

Touch the triangle on seek bar and drag it to any position where you want to start playback.

Fast Forward/Fast Backward

1. Touch [] or [] button and hold 2 seconds to start fast backward or fast forward during playback. The playback speed starts at 2x, then will increase to 4x, 8x, and 16x. Release the button will continue playing with normal speed.

Note:

- No audio is reproduced during fast forward and fast backward operation.
- The fast forward and fast backward speed may differ depending on the disc.

Search function

You can locate the beginning of a scene using the chapter numbers or title numbers recorded on the DVD Video disc.

1. Showing the DVD Video menu, touch [] button. The Key Pad screen appears with the chapter/Title number input mode.

Touching [] button turns the Key Pad to the chapter number input mode.

Touching [] button turns the Key Pad to the title number input mode.

• Title

A large segment to divide the data area of the disc.

• Chapter

A small segment to divide the data area of the disc.

2. Input the number of the title/chapter that you want to play with the [0] to [9] key.
3. Touch the [] button.

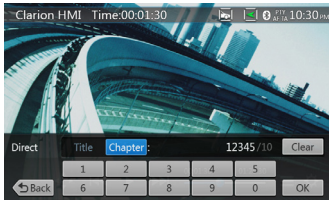

Playback starts from the scene of the input title number or chapter number.

NOTE:

*If the input title/chapter number does not exist or searching with a title/chapter number is not allowed, the screen image will not change.

4. Touch [Back] button to close the key pad.

Repeat Playback

This operation plays back chapters recorded on the DVD-Video repeatedly.

1. Showing the DVD Video menu, touch [Repeat] button.
2. Touch [Repeat] button once for Repeat Chapter, again for Repeat Title.
3. Touch [Repeat] button again to turn off the repeat playback.

Using the Title Menu

On DVD discs containing two or more titles, you can select from the title menu for playback.

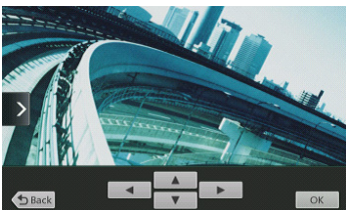

1. Showing the DVD Video menu, touch [Menu] button during playback.

* Depending on the disc, the title menu may not be called.

2. Touch the title menu screen. And touch the Show Cursor keys.
3. Select the items in the title menu screen by [Left] [Up] [Right] [Down] directional buttons.

* Depending on the disc, items may not be selected with the directional buttons.

4. Touch [OK] button to fix on the selected item.
5. Touch [Back] button.

Switching Audio

On discs in which two or more audios or audio languages have been recorded, you can switch among the audio languages during playback.

1. Showing the DVD Video menu, touch [Audio] button during playback.

- Each time you touch the button, you can switch among audio languages.

- It may take time to switch among audios.

Depending on the disc, up to 8 kinds of audios may be recorded. For details, see the mark of the disc: (8) Indicates that 8 audios have been recorded).

When the power is turned on and when the disc is changed to a new one, the language set as the factory default is selected. If that language has not been recorded on disc the language is specified on the disc.

Depending on the disc, switching may be completely impossible or impossible on some scenes.

Switching Subtitles

On DVD discs in with two or more subtitle languages have been recorded, you can switch among the subtitle languages during playback.

1. Showing the DVD Video menu, touch [Subtitle] button to select a subtitle during playback. Each time you touch the button, you can switch among subtitles.

- It may take time to switch among subtitles.

Depending on the disc, up to 32 kinds of subtitles may be recorded. For details, see the mark of the disc: (32) Indicates that 8 kinds of subtitles have been recorded).

Depending on the disc, switching may be completely impossible or impossible on some scenes.

2. To turn off subtitles, repeat touching [Subtitle] button until subtitles are turned off.

Displaying the playback status

Touch [Info] button on DVD Player mode screen, Playback status is displayed on screen.

Play video files

This system can play video files stored on disc.

Showing Video Files Player Mode Screen

1. After disc with video files is loaded, touch [Disc Video] button on MAIN MENU to show video files player mode screen.
2. Touch the screen of the playing video file to display Video files player menu touch the screen again to return the playback screen. The display will return to the playback screen, if you do not touch the screen for 10 seconds.

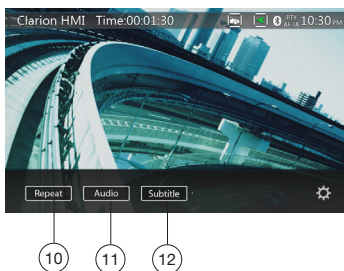

- 1 - Option button
- 2 - Previous Track/Fast Backward button
- 3 - Play/Pause button
- 4 - Next Track/Fast Forward button
- 5 - Elapsed playing time /Seek bar
- 6 - List Mode button
- 7 - System time
- 8 - Bluetooth status indicator
- 9 - Playback information
- 10 - Repeat button
- 11 - Audio button
- 12 - Subtitle button

Operate the Video Files Player Menu

You can select the button items displayed in the Video files player menu by directly touching it.

Play/Pause Playback

1. Touch [⏸] button to pause during playback.
2. Touch [▶] button again to resume playback.

Switch to Previous/Next File

1. Touch [⏮] or [⏭] button during playback to play previous/next file

Skip using seek bar

Touch the ball on seek bar and drag it to any position where you want to start playback.

Fast Forward/Fast Backward

1. Touch [⏮] or [⏭] button and hold 2 seconds to start fast backward or fast forward during playback. The playback speed starts at 2x, then will increase to 4x, 8x, and 16x. Release the button will continue playback with normal speed.

Note:

*No audio is reproduced during fast forward and fast backward operation.

*The fast forward and fast backward speed may differ depending on the disc.

Repeat Playback

This operation plays back video files recorded on the disc repeatedly.

The repeat set as the factory default is Repeat all.

1. Showing the video files player menu, touch [Repeat] button.
2. Touch [Repeat] button once for Repeat Track, again for Repeat Folder.
3. Touch [Repeat] button again for Repeat All.

Switching Audio

Some video files will have two or more audio channels; you can switch among the audio channels during playback.

1. Touch [Audio] button during playback.
 - Each time you touch the button, you can switch among audio languages.
 - It may take time to switch among audios. Depending on the disc, switching may be impossible.

Switching Subtitles

Some video files will have two or more subtitles have been recorded; you can switch among these subtitles during playback.

1. Touch the [Subtitle] button to select a subtitle during playback.
 - Each time you touch the button, you can switch among subtitles.
 - It may take time to switch among subtitles. Depending on the disc, switching may be impossible.

Video Files List

Showing the Video files player menu; touch the [≡] button to display video files list screen.

Video files list operations is almost same as Disc Audio player mode. Please refer to CD Player Operations.

Playable Video Disc Formats

This system can play video files stored on disc.

*.avi files

- format: MPEG4 Visual Simple @L1
- Picture size: 720 x 480
- Audio format: MP3
- Audio sampling frequency: 32/44.1/48 KHz

*.mp4 files:

- format: MPEG4 Visual Simple @L1
- Picture size: 720 x 405
- Audio format: AAC
- Audio sampling frequency: 32/44.1/48 KHz

*.mpg files

- format: MPEG2
- Picture size: 720 x 480
- Audio format: MP3
- Audio sampling frequency: 32/44.1/48 KHz

8. CD PLAYER OPERATIONS

Listening to a Disc/Ejecting a Disc

Please refer to Disc Video Player Operations -watching to a disc and Ejecting a disc.

Showing CD Player Mode Screen

1. After disc is loaded, the play mode is automatically engaged.
2. If disc have been loaded you can touch **[Disc Audio]** button on main menu to display CD player mode screen.

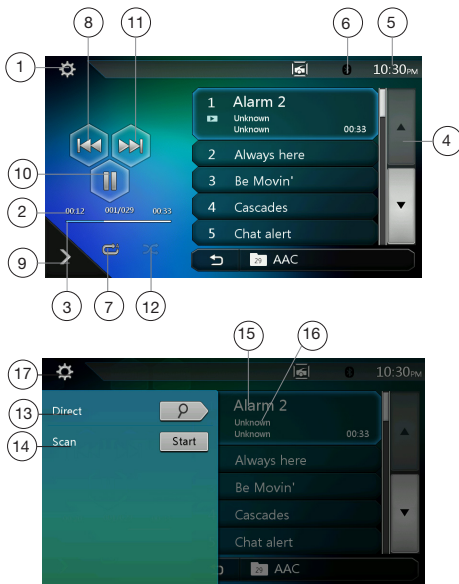

- 1 - Option button
- 2 - Elapsed playing time indicator
- 3 - Progress bar
- 4 - Page Turning button
- 5 - System time
- 6 - Bluetooth status indicator
- 7 - Repeat button
- 8 - Previous Track/Fast Backward button
- 9 - Shortcut button.
- 10 - Play/Pause button
- 11 - Next Track/Fast Forward button
- 12 - Shuffle button
- 13 - Direct Searching button
- 14 - Scan Start/Stop button

- 15 - Song Title
- 16 - Artist/album Information
- 17 - Close option menu Button

Operate the CD Player Menu

You can select the button items displayed in the CD player menu by directly touching it in list.

Play/Pause Playback

1. Touch button to pause during playback.
2. Touch button again to resume playback.

Switch to Previous/Next file or track

Touch or button during playback to play previous/next file.

- Touching button starts playback from the beginning of the next track.
- Touching button starts playback from the beginning of the current track. When this button is touched again within 5 seconds, playback starts from the beginning of previous track.

Fast Forward/Fast Backward

1. Touch or button and hold more than 2 seconds to start fast backward or fast forward during playback. The playback speed starts at 2x, then will increase to 4x, 8x, and 16x. Release the button will continue playback with normal speed.

Note:

* The fast forward and fast backward speed may differ depending on the disc.

Repeat Playback

- * The repeat set as the factory default is Repeat All. Touch button switch between Repeat Folder Repeat All and Repeat Track.

Shuffle Playback

1. Touch button to shuffle the tracks during playback.
2. Touch this button again to turn off the feature.

Selecting a track on the Track List Screen

This function allows you to select tracks from a displayed list.





1. Touch the track title on the display list. The selected track will start playing.
2. When the desired track is not displayed, touch and flick the track list up or down.
3. Touch the desired track title button. The corresponding track is started playback.

Scanning the Tracks



1. Touch  button to show **[Scan Start]** button.
 2. Touch **[Scan Start]** button during playback.
 - It will play from next track, and each track will display for 10 seconds.
 - The **[Scan Start]** button will switch to **[Scan Stop]** button.
 3. Touch **[Scan Stop]** button.
 - It will continue playback from current track.
 - **[Scan Stop]** button will switch to **[Scan Start]** button.
- * The function will scan all tracks orderly in current folder once. After Scan stopped playback will continue.

Searching with the Track Number

This operation allows searching using the track numbers recorded on the CDs.

1. Touch  button to show  button.
2. Touch  button .The numerical keypad will appear on the screen and touch  button.
3. Input the track number that you want to play back with **[0]** to **[9]** key and touch **[OK]** button.

Playback starts from the track of the input track number.

- If the input track number does not exist or searching with track number is not allowed, the screen image will not change.
- Touch the  button will close the numerical keypad.
- Touch  button will close the option window and display playback screen.

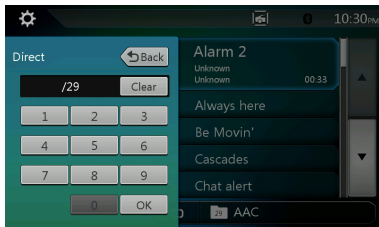

Listening to Compressed Audio

This system can play audio files stored on disc.
MP3/WMA/AAC

Tag Display Function

This unit is an ID3 Tag compatible model.
This unit supports the ID3 TAGs of the Version 2.4, 2.3, 1.1 and 1.0.

In displaying, this unit gives priority to the Version 2.3 and 2.4 TAGs.

Note:

- Some CDs recorded on CD-R/RW mode may not be usable.

Displaying MP3/WMA/AAC TAG titles

Tag information can be displayed for compressed audio file containing Tag information.

Tag data: title, artist, album

Precautions when creating MP3 disc

- **File extensions**
 1. Always add a file extension “.MP3” or “.mp3” to an MP3 file, and “.WMA” or “.wma” to a WMA and “.m4a” to a AAC file by using single byte letters. If you add a file extension other than specified or forget to add these file extension, the file cannot be played. In addition, if you use upper case and lower case letters (capital and small letters) mixed for file extensions, normal play may not be possible.
 2. Files other than MP3/WMA/AAC data cannot be played.

Playing files with a format not supported will be skipped, and the scan, random and repeat playback mode may be canceled.

- **File and Disc Not Supported**

Files and discs with following extensions are not supported: *.AAC, *.DLF, *.M3U, *.PLS, *.MP3 PRO files, files with DRM, open session discs.

- **Logical format (File system)**

1. When writing an MP3/WMA/AAC file on a disc, please select “ISO9660 level 1 or level 2 (without including expansion format)” as the writing software format. Normal playback may not be possible if the disc is recorded on another format.
2. The folder name and file name can be displayed as the title during MP3/WMA/AAC play .

- **Entering File and Folder Names**

Names using the code list characters are the only file names and folder names that can be entered and displayed. Using any other character will cause the file and folder names to be displayed incorrectly.

- **Folder structure**

1. A disc with a folder having more than 8 hierarchical levels will conflict with the ISO9660 and playback will be impossible.

- **Number of files or folders**

1. The maximum allowable number of folders is 200 (including root directory); the maximum allowable number of files is 1500 (max. 200 per folder). This represents the maximum number of tracks that can be played back.
 2. Tracks are played in the order that they were recorded onto a disc. (Tracks might not always be played in the order displayed on the PC).
- Some noise may occur depending on the type of encoder software used while recording.

- In case of a track recorded at VBR (variable bit rate), the display for the play time of the track may be slightly different from the actual play time. Also, the recommended value of VBR ranges from 32 kbps to 320 kbps.
- After disc selection, the play mode is automatically engaged.

Playback MP3/WMA/AAC menu

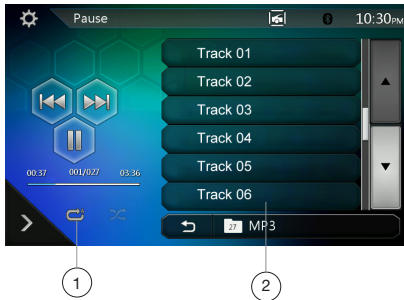

1. Repeat Playback



While playing MP3/WMA/AAC touch  button can switch between Repeat Folder, Repeat All and Repeat Track, Repeat Folder and Repeat All.

2. Current Folder

- Showing title of current folder.
- The number on the folder symbol is the number of files and folders number in current folder.
- Touch the title of current folder, playlist will show files and folders in upper folder.

**Other operations about playing MP3/WMA/AAC are almost same as CD Player mode.*

Stop Playback

1. Touch [] button to stop playback.
2. Touch [] button again to resume playback.

Playback resumes from start of the folder which playing track is in.

- *Other operations about playing MP3/WMA/AAC are almost same as CD Player mode.*

9. USB AUDIO OPERATIONS

This system can play audio files (MP3/WMA/AAC/FLAC) stored in a USB memory which is recognized as "USB Mass Storage Class device". You can use your USB memory as an audio device by simply copying desired audio files into it.

Note:

- This system will not operate or may operate improperly with some USB memory.
- Files protected with any DRM cannot be played.

Notes on Using USB Memories

General notes

- When no support files, the file list display nothing.

Notes on the Audio files

- This system can play the MP3/WMA/AAC/FLAC files stored in the USB memory.

MP3 files:

- format: MPEG1/2 Audio layer3
- bit rate: 8k ~ 320kbps
- sampling frequency: 8/12/16/24/32/44.1/48KHz
- file extension: mp3

WMA files:

- format: Windows media Audio standard L3 profile
- bit rate: 32 ~ 192kbps
- sampling frequency: 32/44.1/48 KHz
- file extension: wma

AAC files

- format: Advanced Audio Coding LC-AAC,HE-AAC
- bit rate: 32 ~ 320Kbps
- sampling frequency: 32/44.1/48 KHz
- file extension: m4a

FLAC files

- format: Free Lossless Audio Codec
- quantization bit rate: 16 or 24 bits
- sampling frequency: 44.1~192 KHz
- file extension: flac

Notes on the folder structure

- The folder hierarchy must be within 8 hierarchical levels. Otherwise, playback may be impossible.
- The maximum allowable number of folders is 65535 (including root directory and folders with no MP3/WMA/AAC/FLAC file).
- The maximum allowable number of files in a folder is 65535.
- You can store the MP3/WMA/AAC/FLAC files together in a folder.

- The system may become slow if the files or folders exceed the limitation above.

Notes on the Tag titles

MP3: title, artist, album

WMA: title, artist, album

AAC: can not display tag information.

FLAC: title, artist, album

Select USB Audio Mode

Connect your USB memory with MP3/WMA/AAC/FLAC files to the USB connector. The system will automatically detect the connected device, and the **[USB Audio]** button on main menu will be enabled.

- When an USB memory is already connected

Touch **[USB Audio]** button to select the USB Audio mode.

The system changes to the USB Audio mode and starts playback from the previous position or from the beginning.

Note:

This system has two USB connectors and can connect two USB.

You can select the desired USB by touching the list of USB root menu.

This system indicate the USB as "My USB1", "My USB2" on the list.

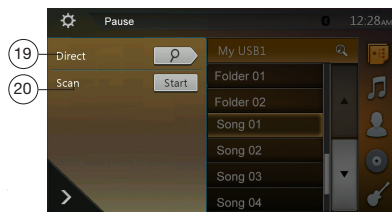



1 - Option button

- 2 - Play/Pause button
- 3 - Previous Track/Fast Backward button
- 4 - Next Track/Fast Forward button
- 5 - Repeat button
- 6 - Shuffle button
- 7 - Audio files in list
- 8 - Folders in list
- 9 - Page turning button
- 10 - System time
- 11 - Bluetooth status indicator
- 12 - Album Art
- 13 - Shortcut button
- 14 - Current ID3 info area
- 15 - Elapsed playing time indicator/Seek bar
- 16 - Playback status information
- 17 - Alphabet search button
- 18 - Category list
- 19 - Direct button
- 20 - Scan button



Playing Audio Files in USB Memory

Play/Pause Playback



1. Touch  button to pause during playback.
2. Touch  button again to resume playback.

Switch to Previous/Next file

Touch  or  button during playback to play previous/next file.

- Touch  button to start playback from the beginning of the next track.
- Touch  button to start playback from the beginning of the current track; when this button is touched again within about 5 seconds, playback starts from the beginning of previous track.

Fast Forward/Fast Backward

Touch  or  button and hold more than 2 seconds to start fast backward or fast forward during playback. The playback speed starts at 2x, then will increase to 4x, 8x, and 16x. Release the button will continue playback with normal speed.

Note:

*The fast forward and fast backward speed may differ depending on the audio files.

Repeat Playback

* The repeat set as the factory default is Repeat All.

Touch the  button once for Repeat Track, again for Repeat Folder, Repeat All.

Shuffle Playback

1. Touch  button to shuffle the tracks in playing folder during playback.
2. Touch this button again to turn off the feature.

Alphabet Search

Touch  button to search with alphabet in current list.

Album Art work

If MP3 audio file contains album art image in ID3, the picture will be displayed in this area.

ID3 Information Area

This area display ID3 information of playing file.

Skip Using Seek Bar

Touch  on seek bar and drag it to any position where you want to start playback.

Select a Folder on Display List









Touch the folder title on the display list, the display list will display files and folders in selected folder.

Selecting a Track on the Display List

This function allows you to select tracks from a displayed list.



1. Touch the track title on the display list. The selected track will start playing.
2. When the desired track is not displayed, touch and flick the track list up or down.
3. Touch the desired track title button. The corresponding track is started playback.

Scanning the Tracks



1. Touch  button to show  button.
 2. Touch  button during playback.
 - It will play from next track, and each track will display for 10 seconds.
 - The  button will switch to  button.
 3. Touch  button.
 - It will continue playback from current track.
 -  button will switch to  button.
- * The function will scan all tracks orderly in current folder once. After Scan stopped, playback will continue.

Searching with the Track Number

This operation allows searching to use the track numbers in playing folder.

1. Touch  button to show  button.
2. Touch  button. The numerical keypad will appear on the screen.
3. Input the track number that you want to play back with [0] to [9] key and touch [OK] button.

Playback starts from the track of the input track number.

- If the input track number does not exist or searching with a track number is not allowed, the screen image will not change.
- Touch  button will close the numerical keypad.
- Touch  button will close the option window and display playback screen.

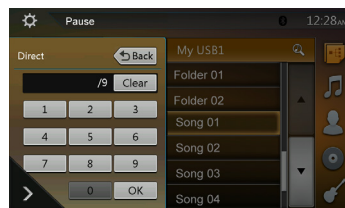

10. USB VIDEO OPERATIONS

This system can play USB video files (MP4, 3GP etc.) stored in a USB memory which is recognized as "USB Mass Storage Class device". You can use your USB memory as an video device by simply copying desired video files into it.

Note:

- This system will not operate or may operate improperly with some USB memory.
- Files protected with any DRM cannot be played.

Notes on Using USB Memories

General notes

When no support files, the file list display nothing.

Notes on the folder structure

The limitations on the folder structure are same as those in USB Audio Player mode.

Notes on the Tag titles

The limitations on the Tag titles are same as those in USB Audio Player mode.

Select USB Video Mode

Connect your USB memory with video files to the USB connector. The system will automatically detect the connected device, and the **[USB Video]** button on main menu will be enabled.

- **When an USB memory is already connected**

Touch **[USB Video]** button on main menu to select the USB Video mode.

The system changes to the USB Video mode and starts playback from the previous position or from the beginning.

Note: This system has two USB connectors and can connect two USB.

You can select the desired USB by touching the list of USB root menu.

This system indicate the USB as "My USB1", "My USB2" on the list.

Playing Video Files in USB Memory

If the video is playing, touch the screen of the playing video to display Operation buttons.

- * The display will return to the playback screen, if you do not touch the screen for 10 seconds.

Playable Video Format

*.mp4 files

- format: MPEG4 Visual
MPEG4 AVC (H.264)
- Picture size: 720 x 480 (MPEG4 Visual)
1920 x 1080 (MPEG4 AVC)
- Audio format: AAC
- Audio sampling frequency: 32/44.1/48 KHz

*.m4v files

- format: MPEG4 Visual
MPEG4 AVC (H.264)
- Picture size: 720 x 480
- Audio format: AAC
- Audio sampling frequency: 32/44.1/48 KHz

*.mpg files

- format: MPEG2
- Picture size: 720 x 480
- Audio format: MP3
- Audio sampling frequency: 32/44.1/48 KHz

*.3gp files

- format: MPEG4 Visual
H.263
- Audio format: AAC, AMR
- Audio sampling frequency: 8/16/32/44.1/48 KHz

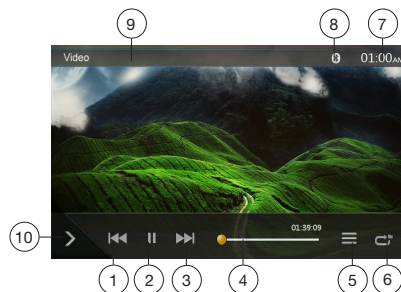

Note:

The above-mentioned File form is not guaranteeing all of what can reproduce.





- 1 - Previous Track/Fast Backward button
- 2 - Play/Pause button
- 3 - Next Track/Fast Forward button
- 4 - Elapsed playing time indicator/Seek bar
- 5 - Menu List
- 6 - Repeat button
- 7 - System time
- 8 - Bluetooth status indicator
- 9 - Playback information
- 10 - Shortcut button

Play/Pause Playback

1. Touch [] button to Pause playback.
2. Touch [] button to resume playback.

Switch to Previous/Next file

Touch [] or [] button during playback to play previous/next file.

- Touch [] button to starts playback from the beginning of the next track.
- Touch [] button to starts playback from the beginning of the current track; when this button is touched again within about 5 seconds, playback starts from the beginning of previous track.

Repeat Playback

* The repeat set as the factory default is Repeat All.
Touch the [] button once for Repeat Track, again for Repeat Folder, again for Repeat All.

Skip Using Seek Bar

Touch the  on seek bar and drag it to any position where you want to start playback.

Switching USB Video Menu

Touch [] button playback will be paused, and the screen will switch to USB Video List.

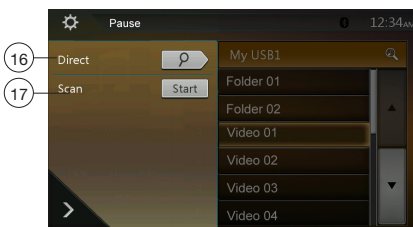

- 1 - Option button
- 2 - Play/Pause button
- 3 - Previous Track/Fast Backward button
- 4 - Next Track/Fast Forward button
- 5 - Repeat button
- 6 - Shuffle button
- 7 - Video files in list
- 8 - System time

- 9 - Bluetooth status indicator
- 10 - Playback status information
- 11 - Album Art
- 12 - Shortcut button
- 13 - Current file information area
- 14 - Elapsed playing time indicator/Seek bar
- 15 - Alphabet search button
- 16 - Direct button
- 17 - Scan button



Play/Pause Playback

*On USB Video menu screen, playback status is pause.

Touch [] button to resume playback. The screen will go to video screen automatically.

Switch to Previous/Next file

Touch [] or [] button during playback to play previous/next file.

- Touch [] button to starts playback from the beginning of the next track.
- Touch [] button to starts playback from the beginning of the current track; when this button is touched again within about 5 seconds, playback starts from the beginning of previous track.

Repeat Playback

* The repeat set as the factory default is Repeat All.
Touch the [] button once for Repeat Track, again for Repeat Folder, again for Repeat All.

Shuffle Playback

1. Touch [] button to shuffle the tracks in playing folder during playback.
2. Touch this button again to turn off the feature.

Alphabet Search

Touch [] button to search with alphabet in current list.

Current File Information Area

This area displays information of current video file: file name, number of current file/total number in current folder, Elapsed playing time/total time of current file.

Skip Using Seek Bar

Touch  on seek bar and drag it to any position where you want to start playback.

Select a Folder on Display List

This operation is same as this in USB Audio mode.

Selecting a Track on the Display List

This operation is same as this in USB Audio mode.

Scanning the Tracks

This operation is same as this in USB Audio mode.

Searching with the Track Number

This operation is same as this in USB Audio mode.

11. iPod OPERATIONS

iPod/iPhone can be connected by using the connector cable supplied with the iPod/iPhone, but in this case, you can enjoy its audio sound only. To enjoy video movies stored in the iPod/iPhone with video displaying them on this unit, it is required to use the special connector cable (CCA-748) separately sold. However the new products such as the device with Lightning connector only can connect 8-pin cable (no video signal output), so these new products cannot display video in video mode.

Note:

- This system will not operate or may operate improperly with unsupported versions.
- For detailed information on the playable iPod/iPhone models, see our home page: www.clarion.com

Notes on Using iPod/iPhone

- Do not connect an iPod/iPhone to this unit with a headphone connected to the iPod/iPhone.
- After the iPod/iPhone has been connected to this unit, the buttons of iPod are disabled for operation in the Music mode. In the Video mode, do not operate the buttons of iPod.
- When in the iPod mode, the screen image input from the AUX terminal, is output to the rear monitor.
- When no data is present, the title display will remain blank.
- Set the language setting of iPod/iPhone to English before connecting your iPod/iPhone. Some characters of the other languages may not be displayed correctly in this system.

• Precautions on battery consumption:

If the iPod/iPhone is connected to this unit when the internal battery of iPod/iPhone has run down, this function may not operate correctly. You must connect the iPod/iPhone after charging the battery if it has run down.

iPod Audio Menu Operations

Connect your iPod/iPhone to the USB connector. The system will automatically detect the connected device and the iPod Audio button will be enabled for operation on the Main Menu screen.

Note:

1. This system has two USB connectors, please connect to the USB with the label of "iPod/iPhone". By connecting another USB cable, iPod/iPhone can't play back the music.
2. When iOS device is connected via both USB and Bluetooth at the same time and select iPod mode, iOS device is controlled by USB connection.
3. When the iPod mode and operate the audio player or internet radio other than iPod, there is a case that

iPod doesn't playback correctly. Please don't operate the audio player or internet radio other than Pandora® when in the Pandora mode.

4. When an iOS device is connected by Bluetooth, and select the iPod mode, the volume level is controlled by both iOS device and the unit.

5. During iOS device is connected by Bluetooth, Album art image is not displayed.

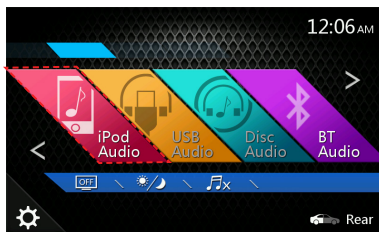



The playback starts after a while, from where the iPod/iPhone has been paused.

- When iPod/iPhone is already connected

Touch the [] button on the Main Menu screen. The system changes to the iPod mode, and starts playback from the previous position.

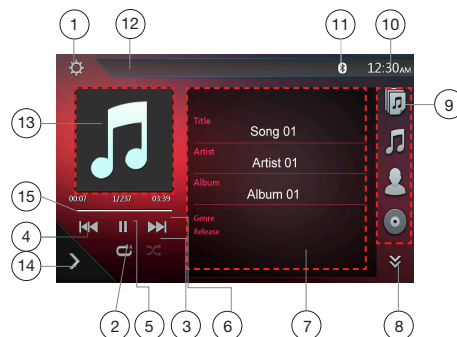

iPod Audio ID3 Mode Screen







- 1 - Option button
- 2 - Repeat button
- 3 - Shuffle button
- 4 - Previous Track/Fast Backward button
- 5 - Play/Pause button
- 6 - Next Track/Fast Forward button
- 7 - ID3 Information
- 8 - Next Page [] / Previous Page [] button

- 9 - Category list
- 10 - System time
- 11 - Bluetooth status indicator
- 12 - Playback status indicator
- 13 - Art work
- 14 - Shortcut button
- 15 - Progress bar



Play/Pause Playback

1. Touch [] button to pause during playback.
2. Touch [] button again to resume playback.

Switch to Previous/Next file

- Touch [] or [] button during playback to play previous/next file.
- Touch [] button to starts playback from the Touch of the next track.
- Touch [] button to starts playback from the beginning of the current track; when this button is touched again within about 5 seconds, playback starts from the beginning of previous track.

Fast Forward/Fast Backward

Touch [] or [] button and hold more than 2 seconds to start fast backward or fast forward during playback.

Note:

**The fast forward and fast backward speed may differ depending on the audio files.*

Repeat Playback

* depend on iPod.

1. Touch the [] button once for Repeat Track, again for Repeat All, again for Repeat Off.

Shuffle Playback

1. Touch [] button to shuffle the tracks in playing folder during playback.
2. Touch this button again to turn off the feature.

Album Art work

If current audio file contains album art image in ID3, the picture will be displayed in this area.

ID3 Information Area

This area display ID3 information of playing file: song title, artist information, album information (Genre, playlist and release time).

Category List

Select different category songs to play. The category is same as the iPod/iPhone.

iPod Audio Playlist Mode Screen

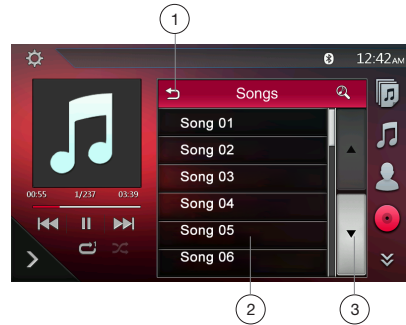



- 1 - Back to parent folder
- 2 - Playing list
- 3 - Page turning button

- In the ID3 information mode screen, touch the ID3 info area to switch the playing list, and in the playing list mode screen, touch the button [] to back to the parent folder. If the list is in root, touch it to close the list.

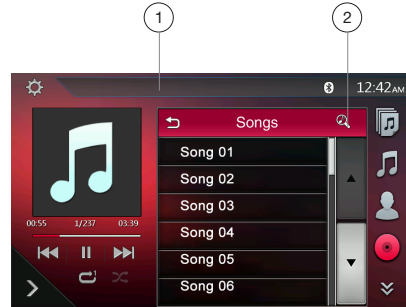
iPod Audio List Mode Screen



- 1 - Back to parent folder
- 2 - Alphabet search button

- Touch the button [] to go back to the parent folder. If the list is in root, touch it to close the list.
- Touch the button [] to search with alphabet in current list

iPod Audio Simple Control Mode Screen

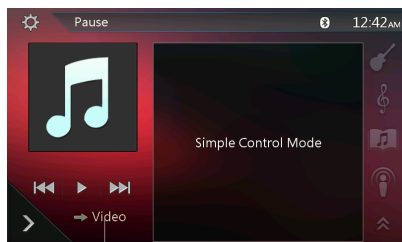
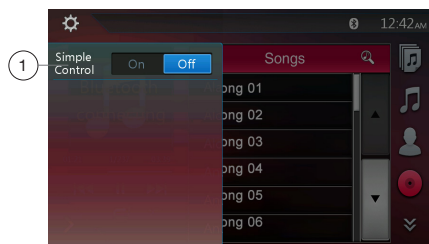

- 1 - Simple Control button.
2 - Video Mode button.

- If the Simple Control is set to **[Off]** in option menu, the screen will become Simple Control Mode. It can also display the video of iPod/iPhone regardless it is iPod Audio or iPod Video mode. But only "Previous Track", "Play/Pause" and "Next Track" can be operated.
- Touch **[Video]** the video will play from iPod.

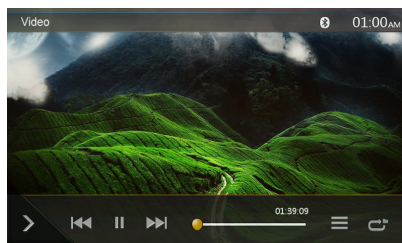

Skipping a Track (Simple Control Mode)

Touch the **[Previous Track]** or **[Next Track]** button during playback. Tracks are skipped, as many times as the button is touched, and playback starts.

- Touch the **[Next Track]** button to starts playback from the beginning of the next track.
- Touch the **[Previous Track]** button to starts playback from the beginning of the current track.

When this button is touched again within about 5 seconds, playback starts from the beginning of the

previous track.

Note: In Simple Control Mode, the best way is to control the iPod just on iPod.

Selecting a list item from a list screen

- Touch the list screen and flick up or down to scroll the list.
- Touch a desired list item on the screen to display the corresponding list of tracks.
- Touch the desired track name on the list to play it.

iPod Video Menu Operations

Connect your iPod/iPhone to the USB connector. The system will automatically detect the connected device and the iPod Video button will be enabled for operation on the Main Menu screen.



- When an iPod/iPhone is already connected

Touch the **[iPod Video]** button on the Main Menu screen. The system changes to the iPod Video mode, and starts playback from the previous position.

Touch MENU button on Operational Panel to return to the Main Menu.

- Viewing video data in the iPod/iPhone (only for the iPod/iPhone with video features)

When you connect an iPod/iPhone with video features by using the optional connector cable for iPod/iPhone with video, you can enjoy the video data and slide show data stored in the iPod/iPhone and show them on the display of this unit (and the rear monitor if connected).

iPod Video ID3 Mode Screen

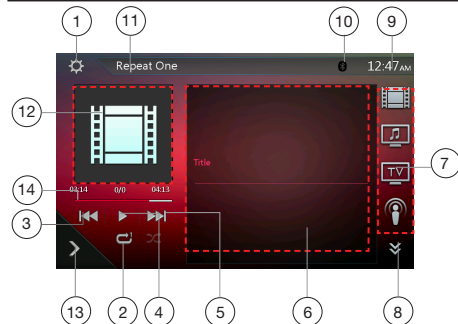

- 1 - Option button
- 2 - Repeat button
- 3 - Previous Track button
- 4 - Play/Pause button
- 5 - Next Track button
- 6 - Playing File title
- 7 - Category list
- 8 - Next Page [▼] / Previous Page [▲] button
- 9 - System time
- 10 - Bluetooth Status indicator
- 11 - Playback Status indicator
- 12 - Art work
- 13 - Shortcut button
- 14 - Progress bar

Play/Pause Playback

1. Touch [⏸] button to pause during playback.
2. Touch [▶] button again to resume playback.

Switch to Previous/Next file

- Touch [⏮] or [⏭] button during playback to play previous/next file.
- Touch [⏭] button to starts playback from the beginning of the next track.
- Touch [⏮] button to starts playback from the beginning of the current track.

Repeat Playback

* The repeat set as the factory default is depend on iPod/iPhone.

1. Touch the [🔁] button once for Repeat One, again for Repeat All, again for Repeat Off.

Album Art work

If current video file contains album art image in ID3, the picture will be displayed in this area.

ID3 Information Area

The area is display the title of the playing file.

Category List

Select different category movies to play. The category is same as the iPod/iPhone.

iPod Video List Mode Screen

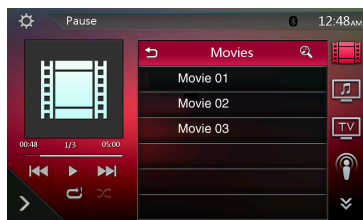

This operation is same as this in iPod Audio mode.

iPod Video Simple Control Mode Screen

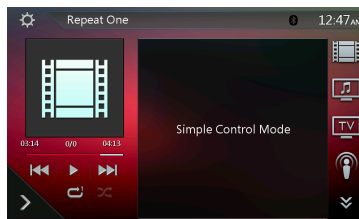
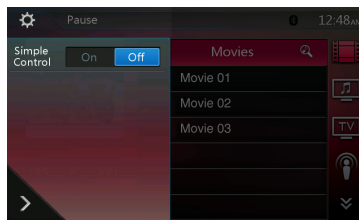

This operation is same as this in iPod Audio mode.

iPod Video Play Mode Screen



- 1 - Previous Track/Fast Backward button
- 2 - Play/Pause button
- 3 - Next Track/Fast Forward button
- 4 - Progress bar
- 5 - Menu List button
- 6 - Repeat button
- 7 - System time
- 8 - Bluetooth status indicator
- 9 - Playback information

Play/Pause Playback

1. Touch [⏸] button to pause during playback.
2. Touch [▶] button again to resume playback.

Switch to Previous/Next Track

- Touch [⏮] or [⏭] button during playback to play previous/next track.

- Touch **[▶▶]** button to starts playback from the beginning of the next track.
- Touch **[◀◀]** button to starts playback from the beginning of the current track; when this button is touched again within about 5 seconds, playback starts from the beginning of previous track. beginning of the current track.

Fast Forward/Fast Backward

Touch **[◀◀]** or **[▶▶]** button and hold more than 2 seconds to start fast backward or fast forward during playback. Release the button will continue playback with normal speed.

Note:

*The fast forward and fast backward speed may differ depending on the video files.

Repeat Playback

* The repeat set as the factory default is Repeat Off. Touch the **[🔁]** button once for Repeat One, again for Repeat All, again for Repeat Off.

Note:

The operation in iPod video mode is as same as iPod Audio mode. Please refer to the iPod Audio Mode operation.

Note:

Video playback is not available on all iPod/iPhone devices. Please contact your Clarion dealer for details. An optional connection cable or accessory may be required for this feature.

Note:

- Video is not displayed when the automobile is moving.
- Image data may not be played back according to the status of the iPod/iPhone.
- The volume setting of video data is relatively lower than audio data. Be sure to lower the volume setting before switching to the other mode.
- Do not select the categories with no track registered from the iPod menu screen. The iPod/iPhone may be frozen. If the iPod/iPhone is frozen, reset the iPod/iPhone by following the procedure described in the instruction manual of the iPod/iPhone.
- Audio may be played back slightly out of synchronization with video images.

iPod Audio Bluetooth Mode

When your iPod/iPhone is connected via Bluetooth to this unit, you can also enter iPod Audio mode. The operation is same as the normal iPod Audio mode.

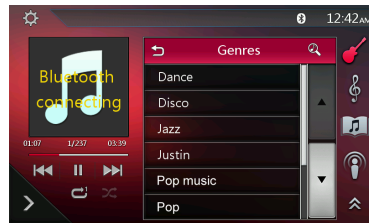

12. Pandora® OPERATIONS

If you have any issues with the Pandora application on your mobile phone, please direct them to pandora-support@pandora.com.

Selecting the Pandora Mode

1. Turn on Pandora function of your iPod.
2. Connect your iPod/iPhone/Android via bluetooth to the unit.
3. When iPod/iPhone/Android is already connected, touch the **[Pandora]** icon on the Main Menu screen.
 - Pandora mode now playing on screen/Pandora mode information screen

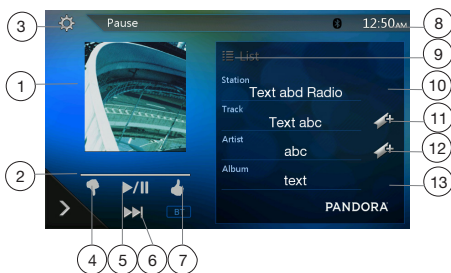

- 1 - Art work
- 2 - Progress bar
- 3 - Settings button
- 4 - Thumbs down

Touch this button Thumbs-down current track and play next track.

- 5 - Play/Pause button

Use to control playback and pause.

(1). Touch the button during playback. Playback pauses.

(2). To resume playback touch the button again.

- 6 - Next track button
- 7 - Thumbs up

- 8 - System time
- 9 - List button

Touch this button to show List Screen.

- 10 - Current station name
- 11 - Current title

Touch icon to store current title to track favorites list.

- 12 - Current artist

Touch icon to store current artist to artist favorites list.

- 13 - Current album name

- Skipping a track (Pandora mode)

Touch **[⏮]** button during playback, tracks are skipped and starts playback from the beginning of the next track.

Note:

- Some track are not able to be skipped.

- If skip limit has been reached(Skip 6 tracks in 1H), this function will not available.
- Track rating
Touch **[👍]** or **[👎]** button to Thumbs down or Thumbs up current track, and the button will light.
Note:
•Touch **[👍]** button will skip to next track (skip limit has not been reached).
- Some track is not able to be rated (i.e. audio ads and shared station content). The thumbs buttons will disable.

- Bookmarking

Touch **[🔖]** button to store current title or artist to track favorites list.

Note:

- Some track are not able to be bookmarked (i.e. audio ads). In this case the bookmark buttons will disable.
- Pandora Mode Station List



- 1 - **[Info]** button

Touch this button to display Information Screen.

- 2 - **[A-Z]** button

Touch this button to sort the list by first letter, touch again to sort the list by date.

- 3 - Station list, touch to select station play.

When the desired station is not displayed, touch and flick the station list up or down.

- Pandora Mode Setting screen

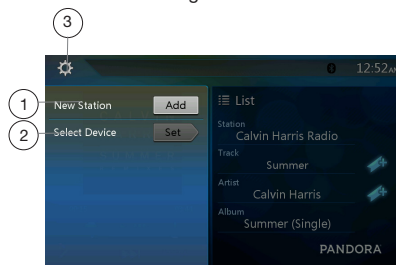

- 1 - Add a new Station
- 2 - Select a device
 - This “Select Device” key is used when connecting iPhone by the USB and connecting the Android by Bluetooth. The default setting, the USB connection has priority
- 3 - Close the setting screen

Pandora Bluetooth Mode

When your mobile phone is connected to the unit via Bluetooth. You can also enter the Pandora mode. The operation is same as the normal Pandora mode.

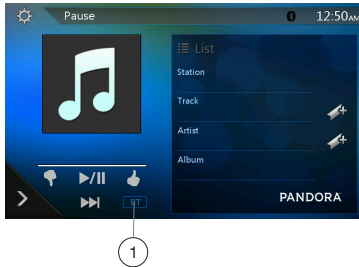

- 1 - BT mode

When connected via Bluetooth. This icon will change from USB to BT

Note:

1. Pandora internet radio may not be available in all areas due to government restrictions.
2. When the Pandora mode starts, this system chooses the previously connected device (Android or iOS). When it is connected Android(BT), iPhone(BT or USB) together, and “Do not show again” is not checked, display the popup of chosen device.
3. When connecting the mobile phone by Bluetooth or USB when in the Pandora mode, there is a case the change device button works correctly. We recommend that after finished the Pandora mode, then connect other mobile phone.
4. When using the Pandora and operating an audio player or internet radio other than Pandora, there is a case that Pandora doesn't playback correctly. Please don't operate the audio player or internet radio other than Pandora when the Pandora mode.
5. During Pandora playback in the Pandora mode with the Bluetooth connection, the volume level is controlled also the mobile phone side. (Both iOS device and Android)

13. Bluetooth AUDIO PLAYER OPERATIONS

Some Bluetooth cellular phones have audio features, and some portable audio players support the Bluetooth feature. These devices will be called as "Bluetooth audio players" in this manual. This system can play audio data stored in a Bluetooth audio player.

Note:

- This system will not operate or may operate improperly with some Bluetooth audio players.
- For detailed information on the playable Bluetooth audio players, see our home page: www.clarion.com

Selecting the Bluetooth Audio Mode

1. Touch the [BT Audio] button to select the Bluetooth Audio mode.

The system changes to the Bluetooth mode. If the connection with a Bluetooth audio player has been already established, you may select the Music function.

2. Press MENU button on Operational Panel to return to the Main Menu.
- When the connection with blue icon a Bluetooth audio player has been established, the [3] icon is displayed at the top of the screen.

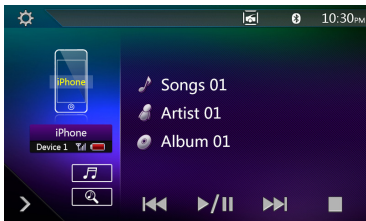

Registering Your Bluetooth Audio Player (Pairing)

You can register up to 5 Bluetooth audio players. Your mobile phone Bluetooth version is under 2.0. Please input PIN code "0000".

1. Turn on the power of the Bluetooth audio player you wish to register.
2. Touch the Device button [+] to display the Device Select screen.

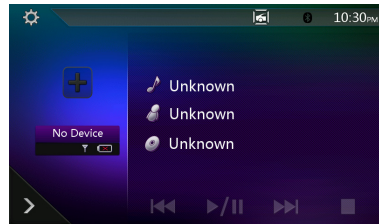

3. Touch the [I+] button to display the Inquiring Device screen.

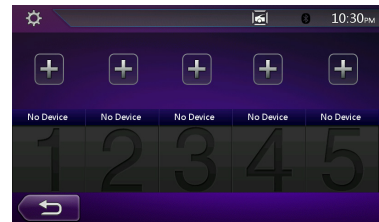

Bluetooth Audio Player Settings

You can confirm various information concerning about the Bluetooth Interface features.

1. Touch the [Settings] button to display the information on the screen.
2. When you finish confirming the Bluetooth information, touch the [Settings] button to return to the previous screen.

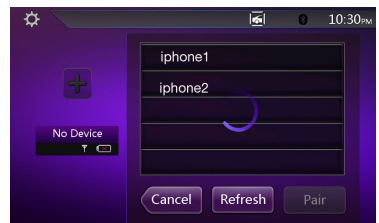
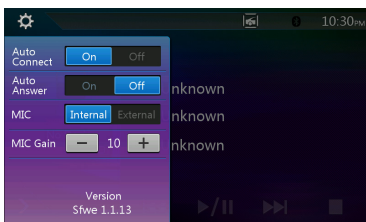

4. Touch your desired device button and touch [Pair] button to register for the Bluetooth audio player. Then select an image of this device.

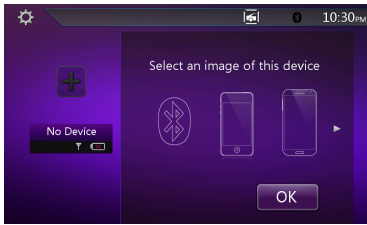

And select a type of this device.

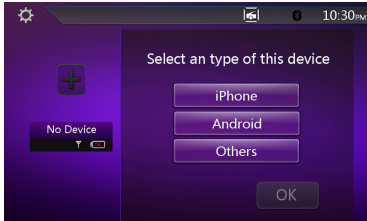

When the pairing operation completes, the registered Bluetooth audio player is set as the current device, after selecting the favorite icon, the display returns to the device list screen. Touch [<=>] button, the display will return to the Bluetooth audio mode screen.

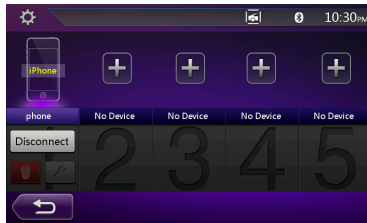

- To delete the Bluetooth audio player registration
1. Touch the [Disconnect] button and then push the [<=>] button to delete the device. A confirmation screen is displayed.
 2. Touch the [OK] button to confirm delete.

Selecting the Bluetooth Audio Player

To change the current Bluetooth audio player to the other device which is already registered, perform the following operation.

1. Touch the device button to [<=>] display the Device Select screen.
2. Touch the currently connected device button, then touch the [Cut] button to disconnect the active device.
3. Touch the desired Device button you wish to use. Touch [Connect] button to select it as your active device. The corresponding cellular phone is set as current telephone.
4. Touch the [<=>] button to return to the previous screen.

Controlling the Bluetooth Audio Player

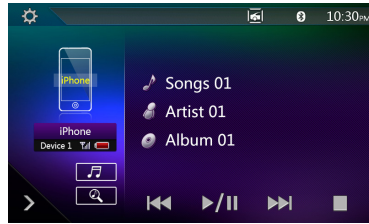

Note:

- Occasionally, depending on the environment, playback sounds may be fragmented, or switch noises may be generated.

Playing Music

After the connection with a Bluetooth audio player is established, the play mode is automatically engaged.

- When playback is not started for some devices, touch the [Play/Pause] button manually.

Pausing Playback

1. Touch the [Play/Pause] button during playback.

Playback Pauses

2. To resume playback, touch the [Play/Pause] button. Playback resumes.

Skipping a Track Searching

3. Touch the [Previous] or [Next] button during playback.

Stopping Playback

4. Touch the [Stop] button during playback.

Tracks are stopped, touch the [Play/Pause] button to playback the first Track.

Show Track List

5. Touch the [Music] button to show the current track list.

Touch the [Search] button to show all of the lists. And you can playback any tracks by touching the items in the list.

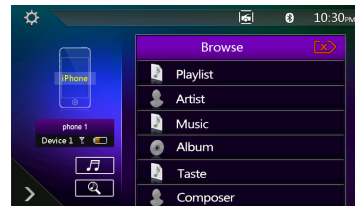
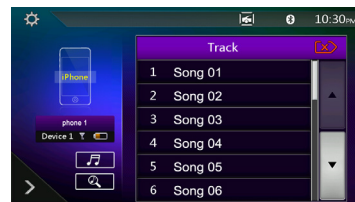

14. Bluetooth TELEPHONE OPERATIONS

When the connection with your Bluetooth cellular phone is established, the following functions are available on this unit:

- Listening to your telephone calls on the car speakers.
- Answering to an incoming call.
- Making a call using the Ten-Key pad screen.
- Making a call using the Phone Book data in the selected cellular phone.
- Making a call using the History data of the dialed/received calls.

Note:

- Some cellular phones may not be able to transfer the Phone Book data to head unit.
- The Phone Book data transmission may take a long time. The operations of sending calls are disabled during the data transmission.

Select the BT Phone Mode

1. Touch the [TEL] button to select the Bluetooth Telephone mode.

The Telephone screen is displayed.

2. Press MENU button on Operational Panel to return to the Main Menu.
- When no Bluetooth telephone is connected, the icon [No Device] is displayed at the top of the screen.

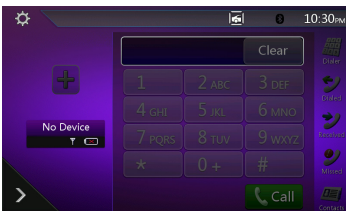

- When the connection with a Bluetooth Telephone has been established, the icon [Phone] and signal level indicator are displayed at the top of the screen.

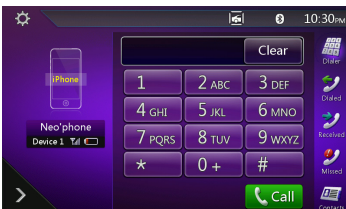

Bluetooth Telephone Settings

You can confirm various information concerning about the Bluetooth Interface features.

1. Touch the [TEL] button to display the information on the screen.
2. Perform setting for the desired item. See the following sections for detail.
3. When you finish confirming the Bluetooth information, touch the [Settings] button to return to the previous screen.

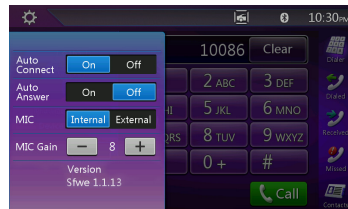

Setting Automatic Connection

The system automatically reconnects the cellular phone after the connection is lost or the system is restarted.

- The factory default setting is "ON". Touch the [On] or [Off] button of the Automatic Connection item to set the function ON or OFF.

Setting Automatic Answer

If a call comes in, answer automatically after 5 seconds.

- The factory default setting is "OFF". Touch the [On] or [Off] button of the Automatic Answer item to set the function ON or OFF.

Setting Microphone Gain

You can adjust the input level of the microphone in 16 levels.

- Touch the level indicator button of the Microphone Gain item to adjust the input level.

Note:

- The input level of the microphone can be affected by its surroundings. Adjust the level if the person on the other end of the telephone has a reception problem.

Registering Your Cellular Phone (Pairing)

You can register up to 5 cellular phones. The registering method is as same as "Registering your Bluetooth audio player".

Your mobile phone Bluetooth version is under 2.0. Please input PIN code "0000".

1. Turn on the power of the cellular phone you wish to register.
2. Touch the Device button  to display the Device Select screen.

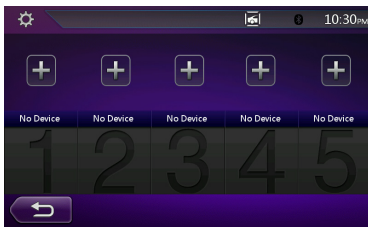
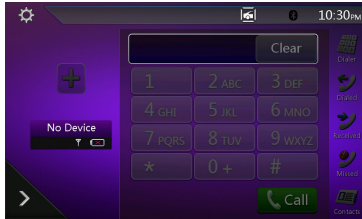

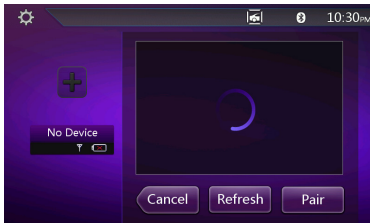

3. Touch the  button to display the Inquiring Device screen.

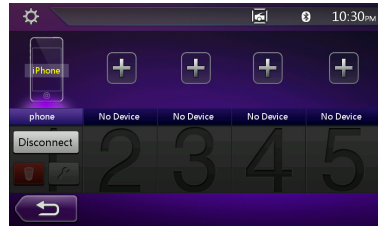

4. Touch your desired Cellular button to select the button for the cellular phone to be registered, and touch  button to register for the Bluetooth cellular phone.
 - You cannot select the Cellular button of which another cellular phone is already registered. Select a blank Cellular button.
5. If entering the Pass Key code is prompted on your cellular phone, enter the Pass Key code set in this unit.
 - You can change the Pass key setting of this unit from the Bluetooth Info screen under the Telephone Settings screen.







When the pairing operation completes, the registered cellular phone is set as the current telephone, and the display returns to the Telephone screen.

- To delete the cellular phone registration
 1. Touch the  button to delete the device. A confirmation screen is displayed.
 2. Touch the  button to confirm delete.

Select the Cellular Phone

To change the current cellular phone to the other device which is already registered, perform the following operation.

1. Touch the  button to display the Device Select screen.
2. Touch the currently connected device, then touch  button to disconnect the active device.
3. Touch the desired Device button you wish to use. Touch  button to select it as your active device. The corresponding cellular phone is set as the current telephone.
 - If the power of the cellular phone is not turned on, turn it on.
 - The cellular phone may prompt to acknowledge the Bluetooth connection or to enter the Pass Key code of this unit. Perform these operations according to the message displayed.
4. Touch the  button to return to the previous screen.

Get the Phone Book Data

Sending the Phone Book data from the cellular phone enables you to make a call using the Phone Book function from this unit.

Telephone Operations

Making a call using the Ten-Key pad

1. Touch the  button to display the Ten-Key pad screen.
2. Enter the telephone number by using the Ten-Key pad displayed on the screen.

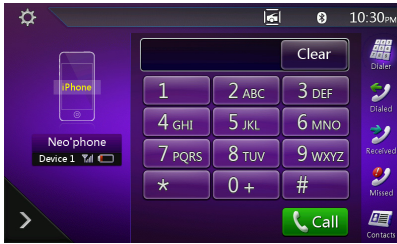

3. Touch the **Call** (Send) button to call the entered number.
 - The following Telephone Interrupt screen is displayed during phone call.

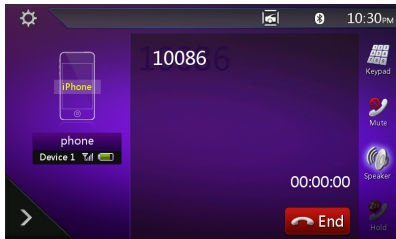

- Touch the **Call** button to talk by using the cellular phone and canceling the hands-free function (Private Mode). To return to the hands-free mode, touch the **Call** button again.
- Touch the **Mute** button to mute the microphone. Now you can hear the other side, but the other side cannot hear your side.
- Touch the **Hold** button to hold the current phone call, now you can answer the other incoming call. Touch again to talk with previous call

If during a call with a third-party call, you can keep the current call to answer a third party or hang up the current call to answer a third party. You can also ignore the third-party calls.

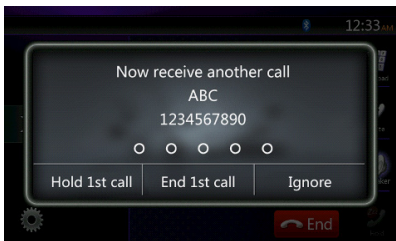

4. When the call is finished, touch **End** button to hang up.

Note:

- Depending on some special cellular phone, the Telephone Interrupt screen may be closed and the connection with this system may be disconnected when entering the Private mode.

Making a Call Using the Phone Book

You can use the Phone Book data obtained from the cellular phone to make a call from this unit.

Note:

- Before using this function, the Phone Book data must be sent from the cellular phone.
- Only the Phone Book items with at least one telephone number registered in the captured Phone Book data are displayed on the Phone Book screen.

1. Touch the **Contact** button to display the Phone Book screen.
2. Touch the desired name button you wish to dial.
 - Flick the list up and down to scroll the list.
3. Touch the **Call** button to call the specified number. The Telephone Interrupt screen is displayed, and calling starts.
- When the call is finished, touch the **End** button to hang up.

Making a Call Using the History

The system will memorize the Dialed/Received calls record data in the memory. You can confirm it and use it to make a call from this unit.

1. Touch the **History** button. The History List screen is displayed.
 - The items are sorted by Dialed, Missed and Received calls.
 - Flick the list up and down to scroll the list.
2. Touch the desired History item key you wish to dial.
3. Touch the **Call** button to call the specified number. The Telephone Interrupt screen is displayed, and calling starts.
- When the call is finished, touch the **End** button to hang up.

Answering an incoming call

When a call comes in, the following Telephone Interrupt screen appears.

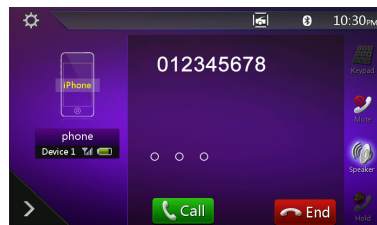

You can answer the incoming call on this system by the following operation.

1. Touch the **Call** button to answer the call.
2. When the call is finished, touch the **End** button to hang up.

Using Siri Eyes Free Function

You can use the Siri Eyes Free function by the following operation.

1. Turn on Siri setting of your iPhone.
2. Press and hold the **[VOICE]** button until you hear the warning tone.

The indicator change as follows.

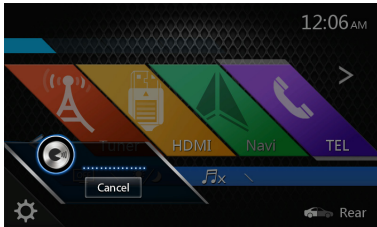

3. Talk to Siri the same way as using it on the iPhone.
4. To finish Siri Eyes Free function, touch the **[Cancel]** button.

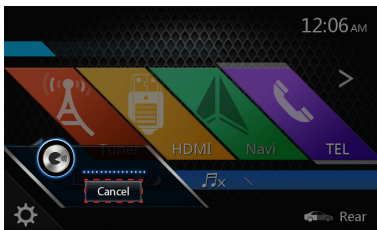

Notes:

Siri Eyes Free is available on iOS 6.1 or higher.

Please use external mic when you use the Siri Eyes Free function.

15. TUNER OPERATIONS

Listening to the Tuner

1. Touch the **[Tuner]** button on the main menu display. The tuner mode screen is displayed.
2. Touch the **[FM1/FM2/FM3/AM]** button to select the radio band. Each time the button is touched, the radio reception band changes in the following order: FM1->FM2->FM3->AM->FM1...

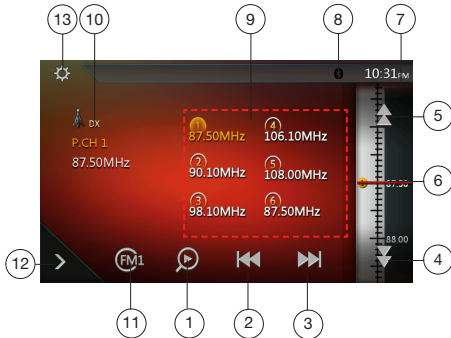

- 1 - Preset Scan button
- 2 - Seek down button
- 3 - Seek up button
- 4 - Step down button
- 5 - Step up button
- 6 - Frequencies display
- 7 - System time
- 8 - Bluetooth status indicator
- 9 - Preset channel list
- 10 - DX/Local indicator
- 11 - Band button
- 12 - Shortcut button
- 13 - Option button

Seek Tuning

1. Touch the **[FM1/2/3/AM]** button to select the radio band (FM or AM).
2. Touch the **[<<<]** or **[>>>]** button
 - When touch the **[>>>]** button, the station is searched in the direction of higher frequency.
 - When touch the **[<<<]** button, the station is searched in the direction of lower frequency.

Step Tuning

1. Touch the **[FM1/2/3/AM]** button to select the radio band (FM or AM).
2. Touch the **[▲]** or **[▼]** button in frequency menu to tune up or down by one step.

Recalling a preset station

1. Touch the **[FM1/2/3/AM]** button to select the desired band (FM or AM) on the tuner.

2. Press the preset station (1 to 6) on Preset list.

Manual memory

1. Touch the desired band button to select the band you wish to store.
2. Tune to a station you want to store using the seek tuning, step tuning, or preset tuning.
3. Touch and hold the desired Preset button you want to store for about 2 seconds.

Auto Store

The Auto Store is a function for storing up to 6 stations that are automatically searched sequentially. If the number of receivable stations cannot reach to 6, the previous stored station remains.

1. Touch the **[FM1/2/3/AM]** button to select the desired band. (FM or AM)
2. Touch the **[AS]** button, and then touch the **[Start]** button to start the Auto Store.

A beep sounds and the stations with good reception are stored automatically to the preset list.

Notes:

1. After auto store, the previous stored stations will be overwritten.
2. The unit has 4 bands, but FM3 and AM can store by Auto Store function.

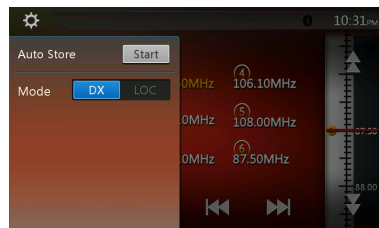

Preset Scan

The Preset Scan receives the stations stored in the preset memory in order. This function is useful when searching for the desired station in memory.

1. Touch the **[FM1/2/3/AM]** button to select the desired band. (FM or AM)
2. Touch the **[PS]** button to start the Preset Scan. The unit starts scanning each station for 10 seconds sequentially. But the station stored is not a valid station; the scanning time is only 2 seconds.
3. When the desired station is tuned in, touch the **[PS]** button again to stay in that station.

DX/Local Setting

The DX/Local setting changes the tuner sensitivity in order to separate closely spaced stations. This feature is useful in areas that have many radio stations in close proximity.

16. HDMI MODE

Wire Connection of HDMI Mode

iPhone 4, iPhone 4s, iPhone 5, iPhone 5s, iPhone 5c, iPhone 6 and iPhone 6 Plus can be connected by using the connector cable supplied with the iPhone 4, iPhone 4s, iPhone 5, iPhone 5s, iPhone 5c, iPhone 6 and iPhone 6 Plus and HDMI cable (sold in the market) and digital AV adapter

Note:

The following is part of the wiring example.

Depending on the device, there is a case to connect to the device directly with the CCA-771.

Depending on the adapter or device, there is a case that the audio noise and video noise is generated.

(1) Connection with the iPhone 4 and iPhone 4s



VX506AU

HDMI cable sold in the market

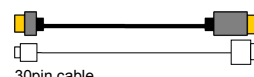

30pin cable
(supplied with iPhone)

iPhone 4 and iPhone 4s

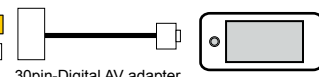

30pin-Digital AV adapter
(made by Apple Inc.)

(2) Connection with the iPhone 5, iPhone 5s, iPhone 5c, iPhone 6 and iPhone 6 Plus



VX506AU

HDMI cable sold in the market

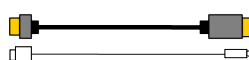

Lightning™ cable
(supplied with iPhone)

iPhone 5, iPhone 5s, iPhone 5c,
iPhone 6 and iPhone 6 Plus



Lightning-Digital AV adapter
(made by Apple Inc.)

(3) Connection with the Android Phone



VX506AU

Micro USB cable sold in the market

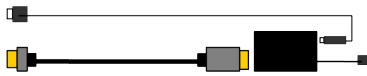

HDMI cable sold in the
market

MHL adapter sold
in the market

Android phone



(4) Connection with the equipment with HDMI output

Electronic devices with HDMI output



VX506AU

HDMI cable sold in the
market



Select HDMI Source

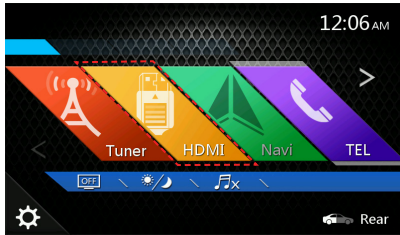

Touch the HDMI menu button, then appear the screen of the connected device.

This HDMI mode is only indicative or a mirror image the screen of the iPhone, Android. You cannot operate by the touch screen of VX506AU

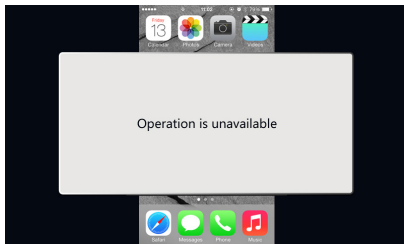

Note:

Depending on the application and model of the mobile phone, there is the case that black frame appears around the screen.

17. AUX

External peripheral devices, including a game console, camcorder, navigation unit, iPod/iPhone, etc. can be connected to the AUX connector on the front or back of this unit using the AV media cables.

Switching to AUX IN

Touch **[AUX1]/[AUX2]** button on Main Menu to select desired mode (when unit is reading). If the external device connected to AUX input have audio signal, the unit will broadcast audio of external device. Press Menu button on Operational Panel to return to the Main Menu.

You cannot directly control external devices connected to AUX input.



18. CAMERA INPUT OPERATIONS

Switching to Camera mode

Touch **[Camera]** button on Main Menu.

The LCD will display the external camera video. The screen will display “No Video Signal” message, if a valid camera is not connect to this head unit.

Press MENU button on Operational Panel to return to the Main Menu.

Setting Camera audio

Select “ON” button in the Camera Audio setting of the General setting.

The audio from camera will heard when back gear is on. The volume control is available but not indicated on the screen due to the safety.

Select “MUTE” button, then mute the audio of the current mode when back gear is on.

Select “Off” button, then play the audio of the current mode when back gear is on.

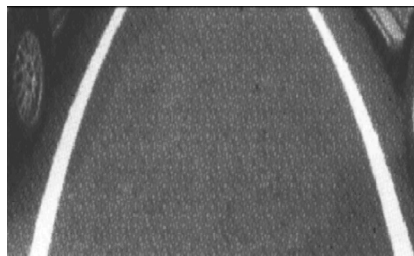
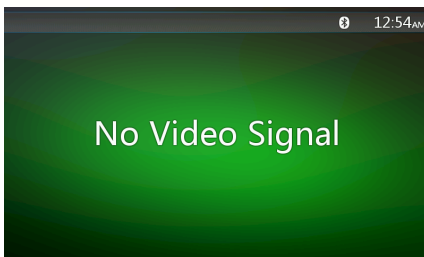

Note:

If the reverse cable is connected correctly to the car, the unit goes to camera mode automatically when the car is in reverses.

As an additional safety feature, the audio from camera with built-in microphones can be heard through the VX506AU.

19. REAR SOURCE OPERATIONS

If a monitor is installed in the rear zone and connected to the rear zone AV output, passengers in the back seat can watch the DVD/iPod Video/AUX1/AUX2 video separately from front source.



1. Touch the button to access the front source.
2. Touch the button to close the rear source.

Multi-Zone Operation

Independent sources can be played simultaneously on the unit. For example, a FM/AM console can be playback on the front screen while DVD video is available to rear passengers. But now can't select DVD video in front.

Access Rear-Zone

1. Touch the Rear button on Main Menu to access the Rear Source.
2. Select a source to play.

Exit Rear-Zone

Touch the 2-Zone off button to close the Rear Source.

Note:

1. If the source is selected as the front, the source in rear can't be selected.
2. If the source is selected as the rear, the source in front can't be selected.
3. Touch the Front button to access the main menu but not close the Rear Source.

DVD Video in Rear

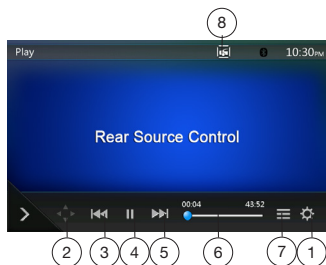

- 1 - Option button
- 2 - Show Cursor keys
- 3 - Previous Chapter/Fast Backward button
- 4 - Play/Pause button
- 5 - Next Chapter/Fast Forward button
- 6 - Elapsed playing time
- 7 - Menu List button
- 8 - Front/Rear button

If the screen displays Rear Source, touch Front/Rear button to switch to Front Source.

If the screen displays Front Source, touch Front/Rear button to switch to Rear Source.

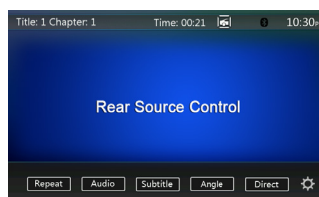

DVD Video Rear Source Control Info Mode.

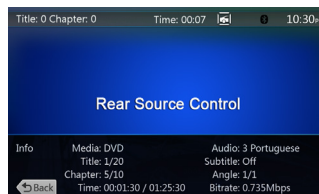

Touch BACK button to return.

DVD Video Rear Source Control Direct Mode.

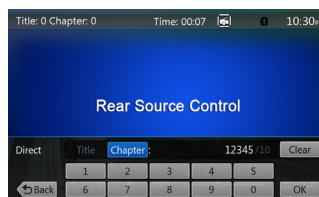

NOTE: More detail please refer to DVD Video Front source.

AUX1

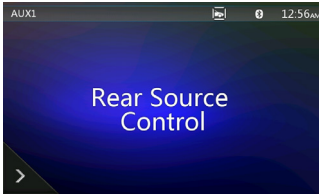

AUX2

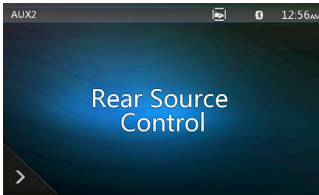

iPod Video Rear Source Control Play Mode

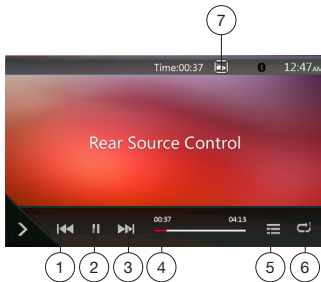

1 - Previous Track/Fast Backward button

2 - Play/Pause button

3 - Next Track/Fast Forward button

4 - Progress bar

5 - Menu List button:

Press the Menu button to display the iPod Video Rear Source mode screen.

6 - Repeat button:

Same as iPod function of front source

7 - Front/Rear button

If the screen displays Rear Source, touch to switch to Front Source.

If the screen displays Front Source, touch to switch to Rear Source.

iPod Video Rear Source ID3 Mode

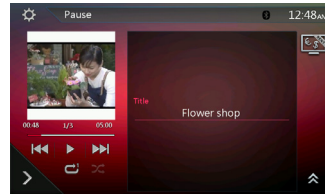
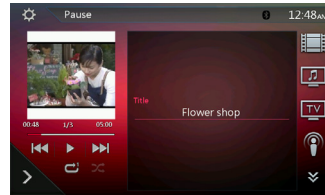

NOTE:

If the source is selected as the front, the source in rear can't be selected.

If the source is selected as the rear, the source in front can't be selected.

Touch the Front button to access the front main menu but the rear source will keep running.

20. SETTING OPERATIONS

Touch [] button on the Main menu screen.
The Setting menu screen will be displayed.

General Setup Menu

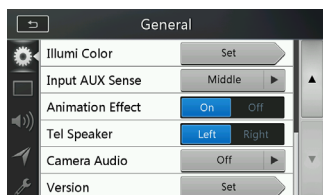
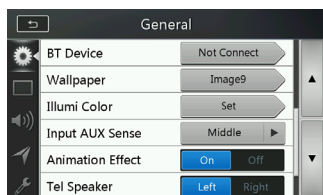
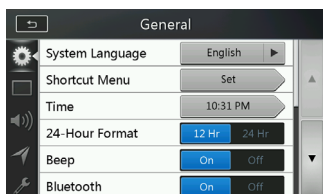

System Language: Set the Language for system screen.

Shortcut Menu: Select menu to be able to select from Shortcut menu and drag it to lower side area.



Time: Set system clock.

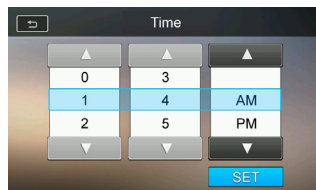

24-Hour Format: Set the time display mode.

Beep: Turn on or turn off the beep confirmation sound.

Bluetooth: Set the Bluetooth On or Off.

Wallpaper: Choose the desired wallpaper.

There are three optional images, which you can import from USB. Select "Imported 1/2/3" and touch [Import].
The format should be jpeg of less than 5M bytes.

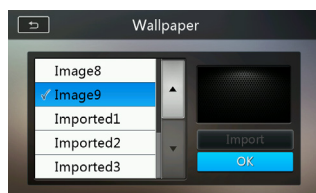

Illumination Color: Set the illumination color on the panel.

Input Aux Sense: AUX input switch, including Low, Middle, High.

Tel Speaker: There are two options, Left and Right. For example, if current setting is Right, when BT phone is coming in, only right speaker can hear the phone.

Camera Audio: There are three options, Off, On and Mute.

Version: Display the software version information.

Note:

- Time and 24-Hour Format can be adjusted when set the system time not to be synchronized with GPS local time.

Video Setup Menu

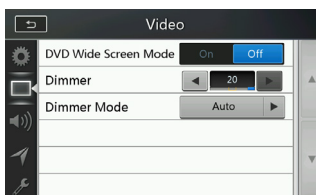

DVD Wide Screen Mode: Set the DVD wide screen mode On or Off.

Dimmer: Set Dimmer value from 0 to 20.

Dimmer Mode: There are three options, Day, Night and Auto.

Audio Setup Menu

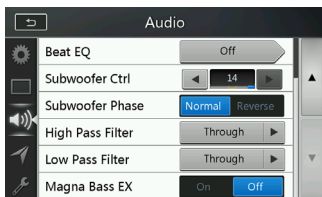
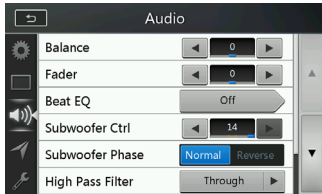

Balance: Choose the desired volume for left and right speaker.

Fader: Choose the desired volume for front and rear speaker.

Beat EQ: Choose the desired mode: Bass Boost, Impact, Excite, Custom and OFF.

Subwoofer Ctrl: Choose the desired subwoofer gain from 0 to 14.

Subwoofer Phase: Choose the Subwoofer Phase normal or reverse.

High Pass Filter: Choose the frequency about the high pass filter or enable. The frequencies include 60Hz, 90Hz and 120Hz.

Low Pass Filter: Choose the frequency about the low pass filter or enable. The frequencies include 60Hz, 90Hz and 120Hz.

Magna Bass EX: Choose the loudness On or Off.

Note:

Optional cable (sold separately) is necessary when you use Audio line out.

Navigation Setup Menu

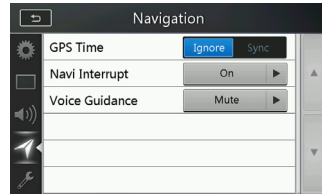

GPS Time: Set the system time to be synchronized with GPS local time or not.

Navi Interrupt: There are three choices: On/Popup/Off. "On": The navigation screen will cover to AV screen when reaching some key point. "Popup": When small turn info window will pop up in the top of the AV screen to indicate the key point. "Off": Turn off this function.

Voice Guidance: There are three choices: On/Mute/Off.

On: Interrupt function of voice guidance is on. While interrupting no attenuate function of AV sound.

Mute: Interrupt function of voice guidance is on. While interrupting attenuate function sound is on.

Off: Disable the navigation voice guidance.

Others Setup Menu

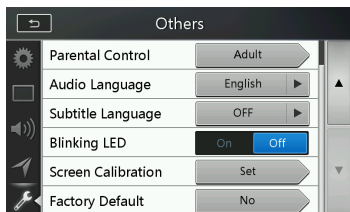
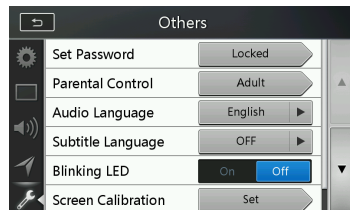

Set Password: Set the password for DVD parental control.

Parental Control: Set the rating of the age. It contains Kid Safe/G/PG/PG-13/PG-R/R/NC-17/Adult.

Audio Language: Set the Language for DVD Audio.

Subtitle Language: Set the Language for DVD subtitle.

Blinking LED: Set blinking LED On or Off.

Screen Calibrate: The function of it is to select the TS Calibrate YES or NO.

Factory Default: The function is to select to load factory default or not.

Set the Anti-Theft Code

1. If your unit is unlocked, hold the  button more than 2 seconds, then the Anti-Theft setting mode will display. Users can change anti-theft code.

Touch [YES] button, the numerical keypad is displayed. Enter the new password twice, then anti-theft code is set and your unit is secured.

When the Anti-theft is "On", you need to enter the correct Anti-theft code to turn the unit on. If you enter wrong code three times, the unit is locked, and must be unlocked by the professionals.

2. If your unit is secured, hold the  button more than 2 seconds, then the Anti-Theft setting mode will display. The numerical keypad is displayed, enter the right code to unlock.

Note:

If the anti-theft code is lost or forgotten, a charge will be incurred at the owner's expense by a Clarion service station to unlock the VX506AU.

21. TROUBLESHOOTING

General

Problem	Cause	Measure
Power does not turn on. (No sound is produced.)	Fuse is blown.	Replace with a fuse of the same amperage. If the fuse blows again, consult your store of purchase.
	Incorrect wiring.	Consult your installation center.
Nothing happens when buttons are pressed. Display is not accurate.	The microprocessor has malfunctioned due to noise, etc.	Press the reset button with a thin rod. Note: <i>When the Reset button is pressed, turn off the ACC power.</i> * When the Reset button is pressed, frequencies of radio stations, titles, etc. stored in memory are cleared.
The remote control unit does not work.	Direct rays of the sun fall on the light-receptive part of the remote control unit.	When direct rays of the sun fall on the light-receptive part of the remote control unit, it may not work.
	The battery of the remote control unit is dead or there is no battery in the remote control unit.	Check the battery of the remote control unit.

DVD Player

Problem	Cause	Measure
Disc cannot be loaded.	A disc is already loaded.	Eject the disc before loading the new one.
	There is foreign matter already in the disc slot.	Remove the foreign matter, or consult a service station.
Sound skips or is noisy.	Disc is dirty.	Clean the disc with a soft cloth.
	Disc is heavily scratched or warped.	Replace with a disc in good condition.
Sound is bad directly after power is turned on.	Condensation may form on the internal lens when the car is parked in a humid place.	Let dry for about 1 hour with the power on.
Video images are not displayed.	The parking brake is not engaged.	Check that the parking brake is engaged.
Disc cannot play with the display "PARENTAL VIOLATION" shown.	Feature exceeds set parental level.	Release the view limitation or change the parental level. See the subsection "Setting up the parental level"

USB Device

Problem	Cause	Measure
USB device cannot be inserted.	The USB device has been inserted incorrectly.	Correct the connection of the USB device, try it again.
	The USB connector is broken.	Replace with a new USB device.
USB device is not recognized.	The USB device is damaged.	Disconnect the USB device and reconnect. If the device is still not recognized, try replacing with a different USB device.
	Connectors are loose.	
No sound heard with the display "NO FILE" shown.	No MP3/WMA file is stored in the USB device.	Store these files properly in the USB device.
Sound skips or is noisy.	MP3/WMA files are not encoded properly.	Use MP3/WMA files encoded properly.
The video image of iPod/iPhone is disturbed.	The TV Signal setting of the iPod/iPhone is not set correctly.	Set the TV Signal setting (NTSC/PAL) of the iPod/iPhone correctly.

Bluetooth

Problem	Cause	Measure
Cannot pair the Bluetooth enable device with the car audio system.	The device does not support the profiles required for the system.	Use another device to connect.
	The Bluetooth function of the device is not enabled.	Refer to the user manual of the device for how to enable the function.
The audio quality is poor after connection with a Bluetooth enabled device.	The Bluetooth reception is poor.	Move the device closer to the car audio system or remove any obstacle between the device and the system.

TFT Screen

Problem	Cause	Measure
The image is not displayed.	The parking brake is not engaged.	Check that the parking brake is engaged.
The display is dark.	The Dimmer control is too low.	Adjust the Dimmer properly.
	The operating condition is not good.	The temperature inside the vehicle may be 0°C or lower. Set to an appropriate temperature (25°C or so) and check it again.
	The headlight of the vehicle is lit.	The display is made dark at night to prevent the glare (When the headlight of the vehicle is lit in the daytime, the display gets dark).
There are red, green, and blue points in display.	-----	This is not a failure, but a phenomenon peculiar to a liquid crystal panel (The liquid crystal panel is produced according to technology with very high precision. Note that, though there are effective pixels of 99.99% or more, pixel missing or normally lit pixels account for 0.01%).

22. ERROR DISPLAY

If an error occurs, one of the following displays is displayed.
Take the measures described below to solve the problem.

DVD Player

Display	Cause	Measure
BAD DISC	A disc cannot be played due to scratches, etc.	Replace with a non-scratched, non-warped disc.
Invalid Disc	A disc is loaded upside-down inside the DVD deck and does not play.	Eject the disc then reload it properly.
PARENTAL VIOLATION	Parental level error.	Set the correct Parental level.
Region code error	Region code error.	Eject the disc, and replace correct region code disc.

23. SPECIFICATIONS

FM Tuner

Frequency Range: 87.5 MHz to 108.0 MHz

Usable Sensitivity: 8 dB μ V

Stereo Separation: 25 dB (1 kHz)

Frequency Response: 30 Hz to 14 kHz

AM Tuner

Frequency Range: 531 kHz to 1,629 kHz

Usable Sensitivity: 30 dB μ V

DVD Player System

Digital Versatile Disc System with CDDA capable

Usable discs:

DVD video disc, Compact disc

Frequency Response: 20 Hz to 20 kHz

Signal/Noise Ratio: 88 dBa (1 W Ref)

Distortion: 0.05%

Video system: NTSC/PAL

Audio/Video Input

Audio input voltage: $\leq 2 V_{rms}$

Video input voltage: $1.0 V_{p-p} @ 75\Omega$

Audio input sensitivity (at 2 V output)

High: $325 mV_{rms}$

Mid: $650 mV_{rms}$

Low: $1.3 V_{rms}$

Audio/Video output

Video output voltage: $1.0 V_{p-p} @ 75\Omega$

Screen Size: 6.0" wide type

Pixels: 1,152,000

Resolution: 800 x 480 x 3 (RGB)

Bluetooth

Specification: Bluetooth Ver 4.0

Profile: HFP1.5(Hands Free Profile)

HSP1.0 (Headset Profile)

A2DP (Advanced Audio Distribution Profile)

AVRCP1.2,1.3,1.4 (AV Remote Control Profile)

PBAP (Phone Book Access Profile)

SPP (Serial Port Profile)

Power Class: 2

USB

Specification: USB 1.1/2.0 (FS)

Playable Audio format:

MP3,WMA,AAC,FLAC

Playable Video format:

AVI,MP4,MPG/MPEG,3gp

General

Power source voltage:

14.4 VDC (10.8 to 15.6 V allowable)

Ground: Negative

Current consumption: 4.0 A @1 W

Auto Antenna Rated Current: 500 mA less

Audio Amplifier

Maximum power output:

180W (45W x 4)

Speaker impedance 4Ω (4 to 8Ω allowable)

Note:

- Specifications and design are subject to change without notice for further improvement.

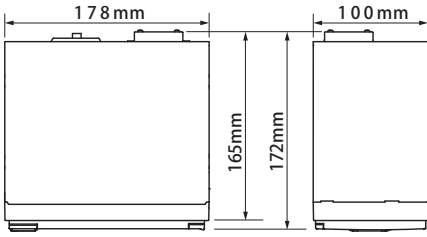

VX506AU dimensions:

VX506AU weight: 2.3 kg

24. WIRE CONNECTION GUIDE

Note:

- Before installing, be sure to disconnect the negative cable of the car battery.
- In the optional devices, the RCA cables and the Connector cables are separately-sold items.
- When connect the HDMI and USB cable, be sure to fix with the clamp.

VX506AU

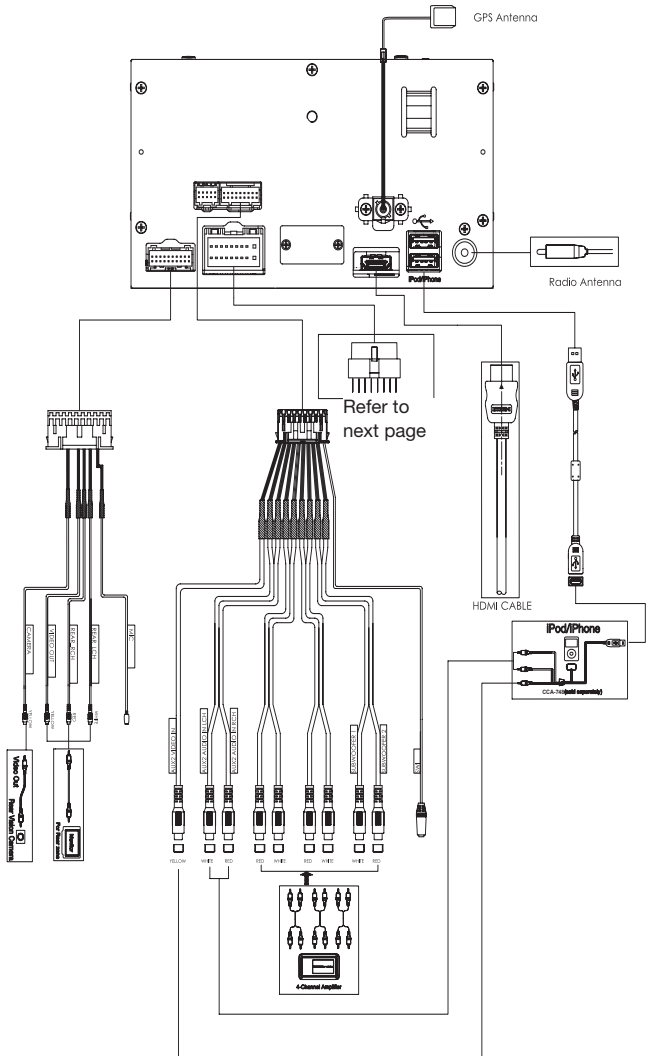

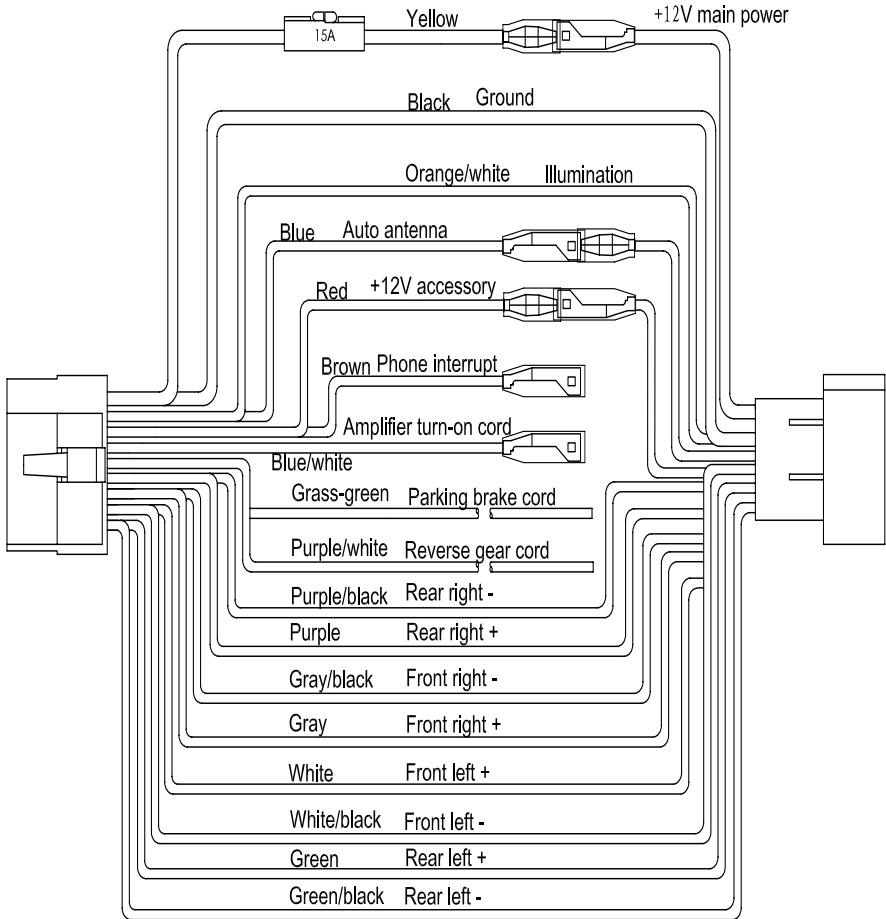

Note:

**1: Connecting the PHONE INTERRUPT terminal
The phone interrupt will mute the audio if the lead receives a negative or ground signal.*

