

clarion®

Owner's manual & Installation manual

使用说明书&安装手册

사용설명서 및 설치설명서

CZ200A

CD/USB/MP3/WMA RECEIVER

CD/USB/MP3/WMA接收机

CD/USB/MP3/WMA 수신기

Contents

Thank you for purchasing this Clarion product.

- Please fully read this owner's manual before operating this equipment.
- Check the contents of the enclosed warranty card and store it in a safe place with this manual.

| | |
|--|-----------|
| 1. FEATURES | 3 |
| Expanding Systems..... | 3 |
| 2. PRECAUTIONS | 4 |
| Front Panel..... | 5 |
| About the Registered Marks, etc. | 5 |
| USB Port | 5 |
| Remove the DCP | 6 |
| Re-attach the DCP | 6 |
| Storing the DCP in the DCP Case..... | 6 |
| 3. CONTROLS | 7 |
| Operational Panel..... | 7 |
| Names of Buttons..... | 7 |
| Remote Control (Sold by separately) | 8 |
| Using the Remote Control | 8 |
| 4. CAUTIONS ON HANDLING | 9 |
| Handling Discs | 9 |
| 5. OPERATIONS..... | 10 |
| Basic Operations | 10 |
| Radio Operations | 11 |
| CD/MP3/WMA Operations | 12 |
| USB Operations | 14 |
| iPod & iPhone Operations | 14 |
| AUX Operations | 15 |
| Audio Setup..... | 16 |
| System Setup | 16 |
| 6. TROUBLE SHOOTING | 17 |
| 7. ERROR DISPLAY | 18 |
| 8. SPECIFICATIONS | 19 |
| 9. INSTALLATION / WIRE CONNECTION GUIDE | 20 |

1. FEATURES

- MP3/WMA compatible with ID3-TAG display
- Detachable Front Panel with 3.5 mm Auxiliary Input
- 4ch/2V RCA Output with Subwoofer Control and BEAT-EQ with 3 Band Parametric Equalizer
- Compatible with iPod®/iPhone™ via USB

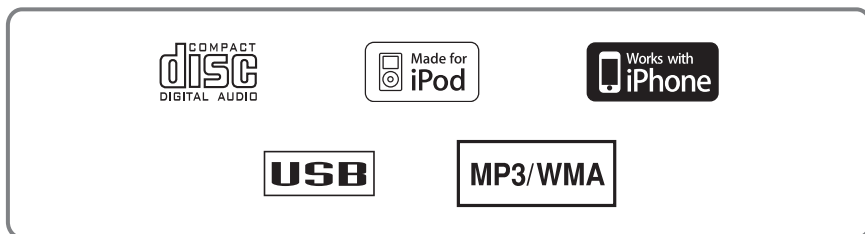

Expanding Systems

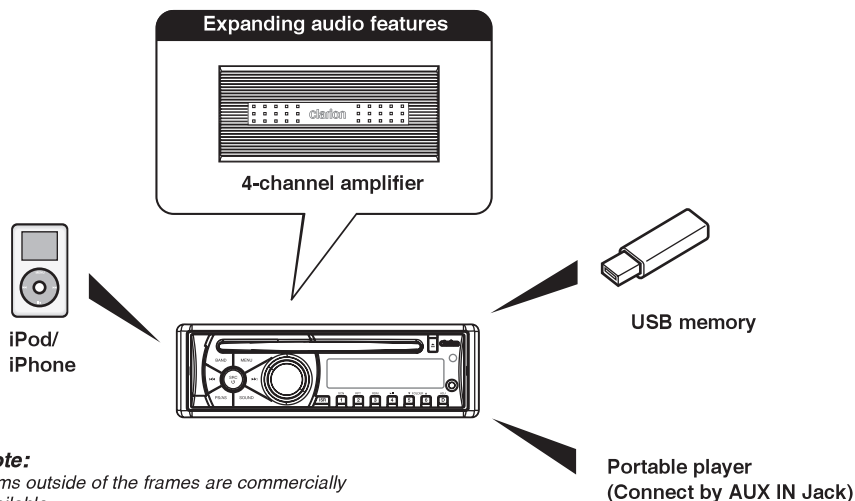

2. PRECAUTIONS

⚠ WARNING

For your safety, the driver should not operate the controls while driving. Also, while driving, keep the volume to a level at which external sounds can be heard.

1. When the inside of the car is very cold and the player is used soon after switching on the heater, moisture may form on the disc or the optical parts of the player and proper playback may not be possible. If moisture forms on the disc, wipe it off with a soft cloth. If moisture forms on the optical parts of the player, do not use the player for about one hour. The condensation will disappear naturally allowing normal operation.
2. Vibrations resulting from driving on bumpy roads may cause the sound to skip.
3. This unit uses a precision mechanism. Even in the event that trouble arises, never open the case, disassemble the unit, or lubricate the rotating parts.

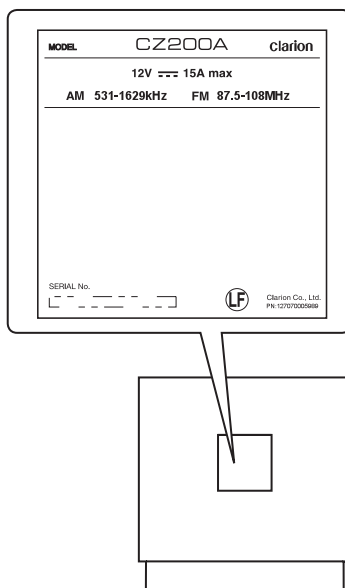

Front Panel

For a longer service life, be sure to read the following cautions.

- Do not allow any liquids on the set. Doing so may damage the internal circuitry.
- Do not disassemble or modify the set in any way. Doing so may result in damage.
- Do not let cigarettes burn the display. Doing so may damage or deform the body.
- If a problem should occur, have the set inspected at your store of purchase.
- The remote control unit may not work if the remote control sensor is exposed to direct sunlight.

Cleaning the body

Use a soft, dry cloth and gently wipe off the dirt.

For tough dirt, apply some neutral detergent diluted in water to a soft cloth, wipe off the dirt gently, then wipe again with a dry cloth.

Do not use benzene, thinner, car cleaner, etc., as these substances may damage the body or cause the paint to peel. Also, leaving rubber or plastic products in contact with the body for long periods of time may cause stains.

About the Registered Marks, etc.

- “Made for iPod” means that an electronic accessory has been designed to connect specifically to iPod and has been certified by the developer to meet Apple performance standards.
“Works with iPhone” means that an electronic accessory has been designed to connect specifically to iPhone and has been certified by the developer to meet Apple performance standards.
Apple is not responsible for the operation of this device or its compliance with safety and regulatory standards.
iPod is a trademark of Apple Inc., registered in the U.S. and other countries.
iPhone is a trademark of Apple Inc.
- ©2009 SIRIUS XM Radio Inc., SIRIUS, XM and all related marks and logos are trademarks of SIRIUS XM Radio Inc. and its subsidiaries.

All other marks, channel names and logos are the property of their respective owners.

USB Port

- When a USB memory stick is used, it may stick out presenting the possibility of injury. Use a USB extension cable to prevent this hazard.
- The USB memory sticks must be recognized as “USB mass storage class” to work properly. Some models may not operate correctly.

Clarion will not be held liable in the unlikely event of loss of or damage to memorized data.

When using an USB memory stick, we recommend that you backup your data on a personal computer.

- Data files may be lost or become corrupted when using USB memory sticks in the following situations: When the USB memory stick is disconnected or the power is turned off during data read or write. When affected by static electricity or electric noise.
When the USB memory stick is connected or disconnected while the contents are being accessed.
- Some USB memory sticks cannot be inserted to the main unit because of their shape. In such cases, use a commercial USB extension cable to connect them.
- Connection to a computer is not supported.
- Music files (MP3, WMA, etc.) stored in the USB memory stick cannot be played back.

Remove the DCP

The control panel can be detached to prevent theft. When detached, keep it in a safe place where it will not be subject to scratches.

We recommend taking the DCP with you when leaving the car.

1. Press the [⏻] button (2 sec.) to turn off the power.
2. Depress the [OPEN] button to unlock the DCP.
3. Grab the edge that pops out and remove the DCP.

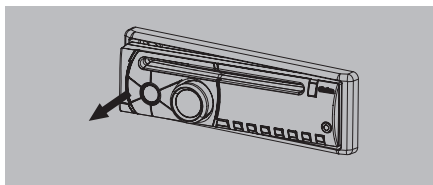

Re-attach the DCP

1. Hold the DCP and ensure that the panel faces towards you. Set the right side of the DCP into the DCP bracket.
2. Press the left side of the DCP until it locks.

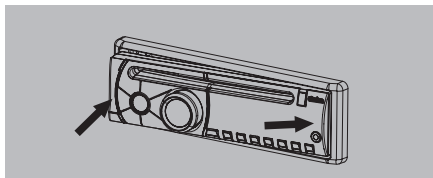

Storing the DCP in the DCP Case

Hold the DCP, in the orientation as shown in the figure below, and put it into the supplied DCP case. (Ensure the DCP is in the correct orientation.)

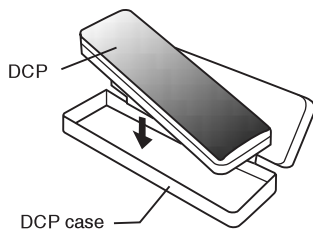

Note:

If the DCP is dirty, wipe off the dirt with a soft, dry cloth only.

⚠ CAUTION

- The DCP can easily be damaged by shocks. After removing it, be carefully not to drop it or subject it to strong shocks.
- Once the [OPEN] button is pressed and DCP is unlocked, car vibrations can cause the DCP to fall.
- The connector connecting the source unit and the DCP is an extremely important part. Be careful not to damage it by pressing on it with fingernails, screwdrivers, or other hard objects.

3. CONTROLS

Operational Panel

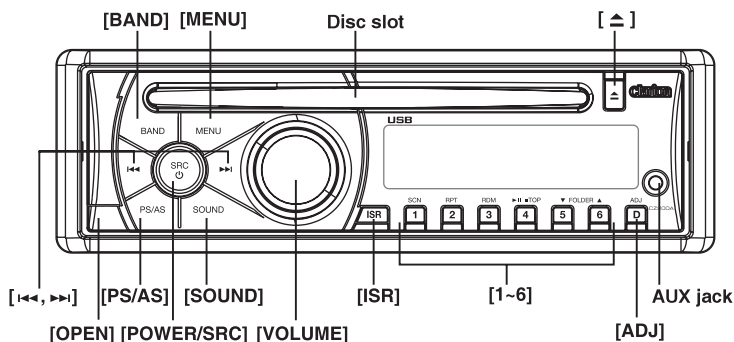

Names of Buttons

[⏻ / SRC] button

- Power/Toggle the audio source

[BAND] button

- Select tuner band

[MENU] button

- System menu

[▲] button

- Eject the disc in the unit.

[◀, ▶] button

- Previous (Next)/Search

[OPEN] button

- Unlock the front panel.

[PS / AS] button

- Preset scan/Auto memory store

[SOUND] button

- Sound effect setting

[VOLUME] knob

- Adjust volume level/Confirm

[ISR] button

- Recall ISR station stored in memory and store current station in ISR memory (long press)

[1-6] button

- [1] button: Scan play/Preset station 1.
- [2] button: Repeat play/Preset station 2.
- [3] button: Random play/Preset station 3.
- [4] button: Play/Pause/Top play (long press)/Preset station 4.
- [5] button: Previous folder/Preset station 5.
10 tracks down (long press)
- [6] button: Next folder/Preset station 6.
10 tracks up (long press)

[ADJ] button

- Display switch/System menu

Remote Control (Sold separately)

[POWER/SRC] button

- Toggle the audio source/Power on/Power off (long press)

[RPT] button

- Repeat play

[◀▶, ▶▶] button

- Preset station up/down/Previous/next track/Search (long press).

[SCN/PS/AS] button

- Scan play/Preset scan/Auto memory store

[BND/TOP] button

- Select tuner band/Top play (long press)

[▲, ▼] button

- Volume up/down

[▶||] button

- Play/Pause

[ISR] button

- Recall ISR station stored in memory and store current station in ISR memory (long press)

[DISP] button

- Display switch

[RDM] button

- Random play

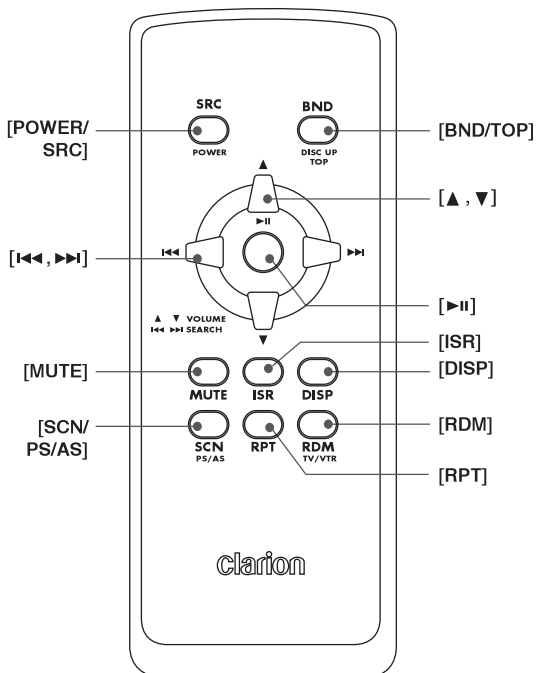

Using the Remote Control

1. Aim the remote control at the remote sensor on the unit.
2. Remove the battery from the remote control or insert a battery insulator if the battery has not been used for a month or longer.
3. DO NOT store the remote control under direct sunlight or in high temperature environment, or it may not function properly.
4. Use button shaped lithium battery CR2025 (3 V) only.
5. DO NOT recharge, disassemble, heat or expose the battery to fire.
6. Insert the battery in proper direction according to the (+) and (-) poles.
7. Store the battery in a place where children cannot reach to avoid the risk of accident.

Inserting the battery

1. Slide remote control unit's rear cover in the direction shown.
2. Insert battery (CR2025) into insertion guides with printed side (+) up.
3. Press battery into compartment as shown.
4. Replace and slide cover until it clicks into place.

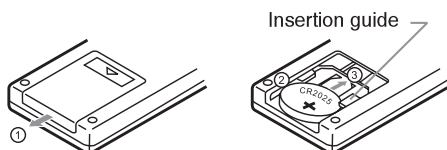

4. CAUTIONS ON HANDLING

Handling Discs

Handling

- New discs may have some roughness around the edges. If such discs are used, the player may not work or the sound may skip. Use a pen or similar tool to remove any roughness from the edge of the disc.

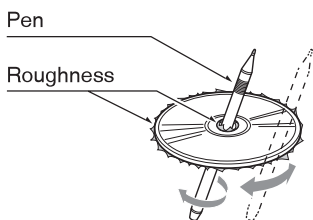

- Never stick labels on the surface of the disc or mark the surface with a pencil or pen.
- Never play a disc with any cellophane tape or other glue on it or with peeling off marks. If you try to play such a disc, you may not be able to get it back out of the player or it may damage the player.
- Do not use discs that have large scratches, are misshapen, cracked, etc. Use of such discs may cause misoperation or damage.
- To remove a disc from its storage case, press down on the center of the case and lift the disc out, holding it carefully by the edges.
- Do not use commercially available disc protection sheets or discs equipped with stabilizers, etc. These may damage the disc or cause breakdown of the internal mechanism.

Storage

- Do not expose discs to direct sunlight or any heat source.
- Do not expose discs to excess humidity or dust.
- Do not expose discs to direct heat from heaters.

Cleaning

- To remove fingermarks and dust, use a soft cloth and wipe in a straight line from the center of the disc to the outer edge.
- Do not use any solvents, such as commercially available cleaners, anti-static spray, or thinner to clean discs.
- After using special disc cleaner, let the disc dry off well before playing it.

On discs

- Exercise a good precaution when loading a disc. The operation panel will close automatically when leaving it open for a while.
- Never turn off the power and remove the unit from the car with a disc loaded.

CAUTION

For your safety, the driver should not insert or eject a disc, opening the operation panel while driving.

5. OPERATIONS

Basic Operations

Note:

- Be sure to read this chapter referring to the chapter "3. CONTROLS."

⚠ CAUTION

Before turning off the unit, return the volume to a lower level. Restarting playback with the volume at maximum increases the possibility of damage to the speakers or your hearing.

Power on/off

Notes:

- Start the engine before using this unit.
 - Be careful about using this unit for a long time without running the engine. If you drain the car's battery too far, you may not be able to start the engine and this can reduce the service life of the battery.
1. Start the engine. The power button will light up.



Engine ON position

2. Press the [⏻] button on the front panel to turn on the power under standby mode. The unit goes back to the last status after power on.
3. Press and hold the [⏻] button on the front panel to turn off the power under work mode.

Mute

Press the [MUTE] button on the remote control to mute the volume from the unit.

Note:

Pressing the [MUTE] button again or adjusting volume will release muting.

Volume adjustment

Turn the [VOLUME] knob on the front panel or press the [▲, ▼] button on the remote control.

The adjustable range of volume is 0 to 40.

⚠ CAUTION

While driving, keep the volume level at which external sounds can be heard.

Playing source selection

Press the [SRC] button on the front panel or the remote control repeatedly to choose desired playing source.

Notes:

1. Playing source selection means selecting work mode, such as DISC mode, Radio mode, Aux mode, etc.
2. When some devices are not ready, they cannot be selected.

Display system time

Press the [ADJ] button on the front panel or [DISP] button on the remote control to switch the display information, system time and playing source.

Radio Operations

Select tuner as playing source

Press the [SRC] button once or more to enter radio mode.

Select one radio band

Press the [BAND] button on the panel or [BND] button on the remote control to select one radio band among FM1, FM2, FM3, AM.

Manual tuning

During manual tuning, the frequency will be changed in steps.

Press the [▶▶1]/[1◀◀] button on the front panel or the remote control to tune in a higher/lower station.

Auto tuning

Press and hold the [▶▶1]/[1◀◀] button on the front panel or the remote control to seek a higher/lower station.

To stop searching, repeat the operation above or press other buttons having radio functions.

Auto store

Only stations with sufficient signal strength will be detected and stored in the memory.

Press and hold [PS/AS] (2 sec.) to start automatic station search.

To stop auto store, press other buttons having radio functions.

Notes:

1. After auto store, the previous stored stations will be overwritten.
2. The unit has four bands: FM1, FM2, FM3 and AM. FM3 and AM can store by AS function. Each bands can store six stations, CZ200A can store 24 stations in total.

Manual store

While tuned into a desired radio station, press and hold number button 1–6 to store it in the memory.

Recall the stored stations

Press one numeric button among 1 to 6 on the panel to select the corresponding stored station.

Local seeking

When LOCAL seeking is on, only those radio stations with strong radio signal can be received.

Press and hold the [ADJ] button on the front panel, then press [▶▶1] button repeatedly until LO or DX displays on the screen, and rotate the knob to select Local or Distant mode.

Note:

The number of radio stations that can be received will decrease after the local seeking mode is on.

Preset scan

Preset scan receives the stations stored in preset memory in order. This function is useful when searching for a desired station in memory.

1. Press the [PS/AS] button.
2. When a desired station is tuned in, press the [PS/AS] button again to continue receiving that station.

Note:

Be careful not to press and hold the [PS/AS] button for two seconds or longer, otherwise the auto store function is engaged and the unit starts storing stations.

CD/MP3/WMA Operations

This unit can play back MP3/WMA files

Note:

If you play a file with DRM (Digital Rights Management) for WMA remaining ON, no audio is output (The WMA indicator blinks).

To disable DRM (Digital Rights Management)

When using Windows Media Player 9/10/11, click on Tool -> Options -> Copy Music tab, then under Rip settings, uncheck the Copy Protect Music box. Then recreate the files. When you disable DRM, you do so at your own responsibility.

Precautions when creating MP3/WMA file

Usable sampling rates and bit rates

1. MP3: Sampling rate 8 kHz-48 kHz, Bit rate 8 kbps-320 kbps/VBR
2. WMA: Bit rate 8 kbps-320 kbps

File extensions

1. Always add a file extension “.MP3”, “.WMA” to MP3, WMA file by using single byte letters. If you add a file extension other than specified or forget to add the file extension, the file cannot be played.
2. Files without MP3/WMA data will not play. The files will be played soundlessly if you attempt to play files without MP3/WMA data.
 - * When VBR files are played, the play time on the display may differ from the actual play location.
 - * When MP3/WMA files are played, there is silence between tunes.

Logical format (File system)

1. When writing MP3/WMA files on a CD-R disc or CD-RW disc, please select ISO 9660 level 1 or 2, Joliet, Romeo or Apple ISO as the writing software format. Normal play may not be possible if the disc is recorded in another format.
2. The folder name and file name can be displayed as the title during MP3/WMA play but the title must be within 64 single

byte alphabetical letters and numerals (including an extension).

3. Do not affix a name to a file inside a folder having the same name.

Folder structure

A disc with a folder having more than eight hierarchical levels cannot be used.

Number of files or folders

1. Up to 999 files can be recognized per folder. Up to 3000 files can be played.
2. Tracks are played in the order that they were recorded onto a disc. (Tracks might not always be played in the order displayed on the PC.)
3. Some noise may occur depending on the type of encoder software used while recording.

Eject function

Just pressing the [▲] button, ejects the disc.

Notes:

- Forcing a CD into the disc slot before auto reloading can damage the CD.
- If a CD (12 cm) is left in the ejected position for 15 seconds, the CD is automatically reloaded (Auto reload).

Listening to a disc already loaded in the unit

Press the [SRC] button to select the CD/MP3/WMA mode.

When the unit enters the CD/MP3/WMA mode, play starts automatically.



Loading a CD

Insert a CD into the center of the disc slot with the labeled side facing up. The CD plays automatically after loading.

Notes:

- Never insert foreign objects into the disc slot.
- If the CD is not inserted easily, there may be another CD in the mechanism or the unit may require service.

CD/MP3/WMA Operations

- Discs not bearing the  or  mark and CD-ROMs cannot be played by this unit.
- Some CDs recorded in CD-R/CD-RW mode may not be usable.

Pausing play

- Press the [**4** / **▶||**] button to pause play. "PAUSE" appears in the display.
- To resume CD play, press the [**4** / **▶||**] button again.

Displaying CD titles

This unit can display title data for MP3/WMA disc.

When SCROLL is OFF, press the [**DISP**] button to change the title display.

MP3/WMA disc

FILE --> FOLDER --> TITLE/ALBUM -->
ARTIST --> FILE -->

Notes:

- If MP3/WMA disc is not input TAG, "NO TITLE" appears in the display.
- Only ASCII characters can be displayed in Tags.

Selecting a track

Track-up

- Press the [**▶||**] button to move ahead to the beginning of the next track.
- Each time you press the [**▶||**] button, the track advances ahead to the beginning of the next track.
- For MP3/WMA disc, press and hold the [**6**] button to move ahead 10 tracks.

Track-down

- Press the [**◀◀**] button to move back to the beginning of the current track.
- Press the [**◀◀**] button twice to move back to the beginning of the previous track.
- For MP3/WMA disc, press and hold the [**5**] button to move back 10 tracks.

Fast-forward/Fast-reverse

Fast-forward

Press and hold the [**▶||**] button.

Fast-reverse

Press and hold the [**◀◀**] button.

- * For MP3/WMA discs, it takes some time until the start of searching and between tracks. In addition, the playing time may have a margin of error.

Folder select

This function allows you to select a folder containing MP3/WMA files and start playing from the first track in the folder.

- Press the [**5**] or [**6**] button.
Press the [**6**] button to move the next folder. Press the [**5**] button to move the previous folder.
- To select a track, press the [**◀◀**] or [**▶||**] button.

Top function

The top function resets the CD player to the first track of the disc. Press and hold the [**TOP**] button (2 sec.) to play the first track (track No. 1) on the disc.

- * In case of MP3/WMA, the first track of a folder being played will be returned.

Other various play functions

Scan play

This function allows you to locate and play the first 10 seconds of all the tracks recorded on a disc.

Press the [**SCN**] button to perform scan play.

Repeat play

This function allows you to repeat playback of a track.

CD:

- Press the [**RPT**] button once or more until "RPT ON" appears on the LCD to perform repeat play.
- Press the [**RPT**] button repeatedly until "RPT OFF" appears on the LCD to cancel repeat playback.

MP3/WMA:

- Press the [**RPT**] button once or more until "TRACK RPT" appears on the LCD to perform repeat play, "RPT" lights. cz200A

CD/MP3/WMA Operations

- For MP3/WMA files, press the **[RPT]** button repeatedly until "FOLDER RPT" appears on the display for folder repeat play.
- Press the **[RPT]** button repeatedly until "RPT OFF" appears on the display to cancel repeat playback, "RPT" goes off.

Random play

This function allows you to play all tracks

recorded on a disc in a random order. Press the **[RDM]** button to perform random play. Random play starts with the next played track when Random function is on.

USB Operations

- Insert a USB device into the USB connector.
When connecting a USB device, the unit will read the files automatically.
- To remove the USB device, you should first select another source, in order to avoid damaging the USB device. Then remove the USB device.

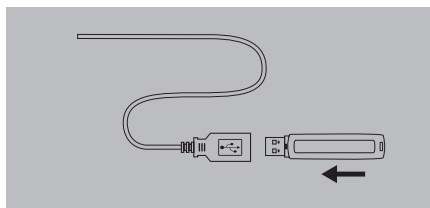

iPod & iPhone Operations

Connect

Connect an iPod or iPhone to the USB using a USB cable.

When connecting a device, the unit will read the files automatically. The track information displays on the screen once playback starts.

MENU

Press the **[MENU]** button repeatedly to show PLAY LISTS, rotate the knob to show PLAY LISTS / ARTISTS / ALBUMS / GENRES / SONGS / COMPOSERS, press and rotate the knob to select a desired option, then press the knob to confirm.

Repeat play

This function allows you to play the current track repeatedly or play all tracks in your iPod/iPhone repeatedly.

- Press the **[RPT]** button once or more until "TRACK RPT" appears on the LCD to perform repeat play.
- Press the **[RPT]** button repeatedly until

"ALL RPT" appears on the LCD for all tracks repeat play.

- Press the **[RPT]** button repeatedly until "RPT OFF" appears on the LCD to cancel repeat playback.

Random play

This function allows you to play all tracks recorded on a disc in a random order.

- Press the **[RDM]** button once or more until "SONG RDM" appears on the LCD to perform random play.
- Press the **[RDM]** button repeatedly until "ALBUM RDM" appears on the LCD for album random play.
- Press the **[RDM]** button repeatedly until "RDM OFF" appears on the LCD to cancel random playback.

AUX Operations

Press the [**SRC**] button on the panel or remote control to select AUX.

AUX is just for Audio content with 3.5 mm Jack connector plugged into audio-in socket on the front panel.

AUX input sensitivity setting

1. Press the [**ADJ**] button.
2. Turn the [**VOL/SEL**] knob to select "AUX MID".
3. If the output level of connected external audio player is "High", rotate [**VOL/SEL**] knob and choose "AUX LOW". And if the output level is "Low", choose "AUX HIGH".

Audio Setup

Press the **[SOUND]** button to enter sound effect setting mode. First press shows current EQ. Rotate the **[VOLUME]** knob to change the options in the following order: OFF -> B-BOOST -> IMPACT -> EXCITE -> CUSTOM

Press the **[SOUND]** button, then press **[◀, ▶]** to select USER preset including:

BALANCE -> FADER -> M-B EX -> LPF(low pass filter) -> SUBW VOL, rotate the **[VOLUME]** knob to select a value.
BALANCE: LEFT 1-7 -> CENTER -> RIGHT 1-7
FADER: LEFT 1-7 -> CENTER -> RIGHT 1-7
M-BEX: ON/OFF
LPF: THROUGH/80/120/160
SUBW VOL: (-6)-(+6)

System Setup

In the radio mode, press and hold the **[ADJ]** button to enter system MENU. Press **[◀, ▶]** to select options, rotate the **[VOLUME]** knob to adjust.

CLOCK

Press the knob to enter clock setting mode, Rotate the knob to set clock, press **[◀◀]** or **[▶▶]** to select hour or minute, press and hold the knob to confirm.

DX/LO

In the radio mode, rotate the knob to choose radio local or distant.

LO: Only stations with strong signal can be received.

DX: Stations with strong and weak signals can be received.

AUX SENS

Rotate the knob to choose AUX Input sensitivity LOW, MID or HIGH at AUX mode.

SCRN SVR: ON/OFF

Rotate the knob to choose screen saver on or off.

SCROLL: ON/OFF

For track information that is longer than the display panel:

When SCROLL is ON, the LCD will display ID3 TAG information cyclely, e.g: TRACK -> FOLDER -> FILE -> ALBUM -> TITLE -> ARTIST -> TRACK ->...

When SCROLL is OFF, the LCD will display one of the ID3 TAG information, the default is TRACK, but user can adjust it to other ID3 TAG information by pressing the **[DISP]** button.

DIMMER: ON/OFF

Rotate the knob to choose dimmer on or off.

ON: The LCD is dimmed when the interior light is on.

OFF: The LCD stays at maximum brightness.

REAR/S-W

Rotate the knob to choose REAR LINE OUT or SUB-WOOFER.

TEL-SW

Rotate the knob to choose TELE-PHONE MUTE, ON or OFF.

OFF: This unit continues normal operation even when the cellular phone is used.

ON: You can listen to your telephone calls from the speakers connected to this unit.

*When listening to your calls on your car speakers, you can adjust the volume by turning the **[VOLUME]** knob.

MUTE: The sound from this unit is muted during telephone calls.

BEEP: ON/OFF

Rotate the knob to choose button beep sound on or off.

12/24H

Rotate the knob to choose time format: 12 or 24 hour.

6. TROUBLE SHOOTING

General

| Problem | Cause | Measure |
|---|--|--|
| Unit does not turn on. | Unit fuse blown. | Install new fuse with correct rating. |
| | Car battery fuse blown. | Install new fuse with correct rating. |
| Unit does not turn on. Nothing happens when buttons are pressed. Display is not accurate. | Illegal operation. | Turn off the power and open the operation panel. Press the Reset button with a thin rod. Note: When the Reset button is pressed, turn off the ACC power.* |
| | | *When the Reset button is pressed, frequencies of radio stations, titles, etc. stored in memory are cleared. |
| Remote control does not work. | Battery depleted. | Change the battery. |
| | Battery installed incorrectly. | Install the battery correctly. |
| No/low audio output. | Improper audio output connection. | Check wiring and correct. |
| | Volume set too low. | Increase volume level. |
| | Speakers damaged. | Replace speakers. |
| | Heavily biased volume balance. | Adjust the channel balance to center position. |
| | Speaker wiring is in contact with metal part of car. | Insulate all speaker wiring connections. |
| Poor sound quality or distortion. | Non-standard disc used. | Use a standard disc. |
| | Speaker power rating does not match unit. | Replace speakers. |
| | Wrong connections. | Check wiring and correct. |
| | Speaker is shorted. | Check wiring and correct. |
| Tel-Mute malfunction. | MUTE wire is grounded. | Check the 'MUTE' wiring and correct. |
| Unit resets itself when engine is off. | Incorrect connection between ACC and Battery. | Check wiring and correct. |

DISC player

| Problem | Cause | Measure |
|---|---|--|
| Disc cannot be loaded. | Another disc is already loaded. | Eject the disc before loading the new one. |
| | There is a foreign object already in place. | Eject the foreign object forcibly. |
| Sound skips or is noisy. | Compact disc is dirty. | Clean the compact disc with a soft cloth. |
| | Compact disc is heavily scratched or warped. | Replace with a compact disc with no scratches. |
| Sound is bad directly after power is turned on. | Water droplets may form on the internal lens when the car is parked in a humid place. | Let dry for about one hour with the power on. |

USB devices

| Problem | Cause | Measure |
|--|--|--|
| USB device cannot be inserted. | The USB device has been inserted with wrong direction. | Reversing the connection direction of the USB device, try it again. |
| | The USB connector is broken. | Replace with a new USB device. |
| USB device is not recognized. | The USB device is damaged. | Disconnect the USB device and reconnect. If the device is still not recognized, try replacing with a different USB device. |
| | Connectors are loose. | |
| No sound heard with the display "No File" shown. | No MP3/WMA file is stored in the USB device. | Store these files properly in the USB device. |
| Sound skips or is noisy. | MP3/WMA files are not encoded properly. | Use MP3/WMA files encoded properly. |

7. ERROR DISPLAY

If an error occurs, one of the following errors is displayed.
Take the measures described below to solve the problem.

| Display | Cause | Measure |
|---------|--|---|
| ERROR 3 | Disc is inserted incorrectly. | Eject the disc then reload it properly. |
| | The disc format is not supported. | Try another disc. |
| ERROR 5 | This is a failure of deck's mechanism. | Consult your store of purchase. |

If an error display other than the ones described above appears, press the Reset button. If the problem persists, turn off the power and consult your store of purchase.

- * When the Reset button is pressed, frequencies of radio stations, titles, etc. stored in memory are cleared.

8. SPECIFICATIONS

FM tuner

Frequency range: 87.5-108.0 MHz
 Usable sensitivity: 8 dB μ
 Frequency response: 30 Hz-15 kHz
 Stereo separation: 30 dB (1 kHz)
 Signal/noise ratio: >55 dB

AM tuner

Frequency range: 531-1,629 kHz
 Usable sensitivity (S/N=20 dB): 30 dB μ

CD

System: Disc digital audio system
 Frequency response: 20 Hz-20 kHz
 Signal/noise ratio: >75 dB
 Total harmonic distortion: Less than 0.1% (1 kHz)
 Channel separation: >60 dB

MP3/WMA mode

MP3 sampling rate: 8 kHz to 48 kHz
 MP3 bit rate: 8 kbps to 320 kbps / VBR
 WMA bit rate: 8 kbps to 320 kbps
 Logical format: ISO 9660 level 1, 2
 Joliet or Romeo file system

USB

Specification: USB 1.0/2.0
 Playable audio format:
 MP3 (.mp3): MPEG 1/2/Audio Layer-3
 WMA (.wma): Ver 7/8/9, 1/9.2

Audio amplifier

Maximum power output:
 180 W (45 W \times 4)
 Speaker impedance: 4 Ω (4 to 8 Ω allowable)

Input

Audio input sensitivity:
 High: 320 mV (at 1 V output)
 Mid: 650 mV (at 1 V output)
 Low: 1.3 V (at 1 V output)
 (input impedance 10 k Ω or greater)
 Aux-in level: \leq 2 V

General

Power supply voltage:
 14.4 VDC (10.8 to 15.6 V allowable), negative ground
 Pre-Amp output voltage:
 2.0 V (CD play mode: 1 kHz, 0 dB, 10 k Ω load)
 Fuse: 15 A
 Dimensions of the main unit (W \times H \times D):
 188 \times 58 \times 190 mm
 Weight of the main unit: 1.35 kg

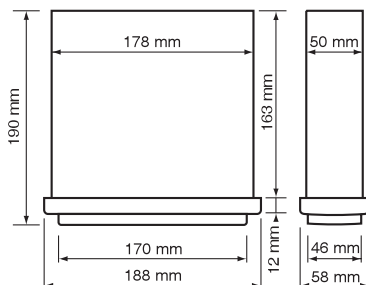

Notes:

- Specifications comply with JEITA Standards.
- Specifications and design are subject to change without notice for further improvement.

9. INSTALLATION/WIRE CONNECTION GUIDE

CONTENTS

| | |
|-------------------------------------|----|
| 1) Before Starting | 20 |
| 2) Package Contents | 20 |
| 3) General Cautions | 20 |
| 4) Cautions on Installation | 21 |
| 5) Installing the Source Unit | 21 |
| 6) Removing the Source Unit | 23 |
| 7) Wiring and Connections | 24 |
| 8) Connecting the Accessories | 25 |

1) Before Starting

1. This set is exclusively for use in cars with a negative ground 12 V power supply.
2. Read these instructions carefully.
3. Be sure to disconnect the battery terminal before starting. This is to prevent short circuits during installation. (Figure 1)

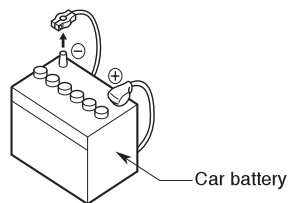

Figure 1

2) Package Contents

| | | | |
|------------------------|---|----------------------|---|
| Source unit | 1 | L-key | 2 |
| Front panel | 1 | Wire connector | 1 |
| Trim ring | 1 | Owner's manual | 1 |
| Mounting bracket | 1 | Strap | 1 |
| Screw M4x5 mm | 1 | | |
| Screws M5x6 mm | 4 | | |

3) General Cautions

1. Do not open the case. There are no user-serviceable parts inside. If you drop anything into the unit during installation, consult your dealer or an authorized Clarion service center.
2. Use a soft, dry cloth to clean the case. Never use a rough cloth, thinner, benzine, or alcohol. For tough dirt, apply a little cold or warm water to a soft cloth and wipe off the dirt gently.

4) Cautions on Installation

1. Prepare all articles necessary for installing the source unit before starting.
2. Install the unit within 30° of horizontal. (Figure 2)
3. If you have to do any work on the car body, such as drilling holes, consult your car dealer beforehand.
4. Use the enclosed screws for installation. Using other screws can cause damage. (Figure 3)

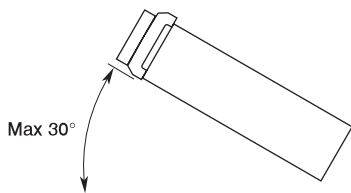

Figure 2

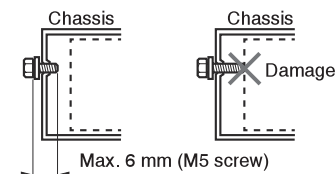

Figure 3

5) Installing the Source Unit

1. Place the mounting bracket into the instrument panel, use a screwdriver to bend each stopper of the universal mounting bracket inward, then secure the stopper.
2. Insert the source unit into the mounting bracket until it locks.
3. Carefully adjust all mounting tabs on the mounting bracket and confirm that the mounting tabs are securely attached.

Notes:

1. Some car models require special mounting kits for proper installation. Consult your Clarion dealer for details.
2. Fasten the front stopper securely to prevent the source unit from coming loose.

• Console opening dimensions

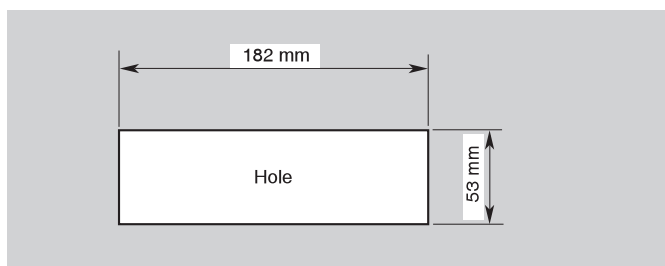

Notes on installation

1. Before installation, please make sure that all connections have been properly made and the unit operates normally. Improper connection may result in damage to the unit.
2. Use only accessories designed and manufactured for this unit. The use of other unauthorized accessories may result in damage to the unit.
3. Before installation, please fasten all power cables.
4. DO NOT install the unit where it will be exposed to heat to prevent damage to electrical components such as the laser head.
5. Install the unit horizontally. Installing the unit more than 30 degree vertically may result in degraded performance.
6. To prevent electric spark, connect the

positive pole first and then the negative pole.

7. DO NOT block the cooling fan exit to ensure sufficient heating dissipation of this unit, or it may result in damage to this unit.

Unit installation

Method A

Universal Mount

1. Insert mounting bracket into dash board, choose appropriate mounting tab according to the gap width, bending the mounting tab outwards with a screwdriver to fix the mounting bracket in place.
2. Slide the unit into the bracket until you hear a click sound.

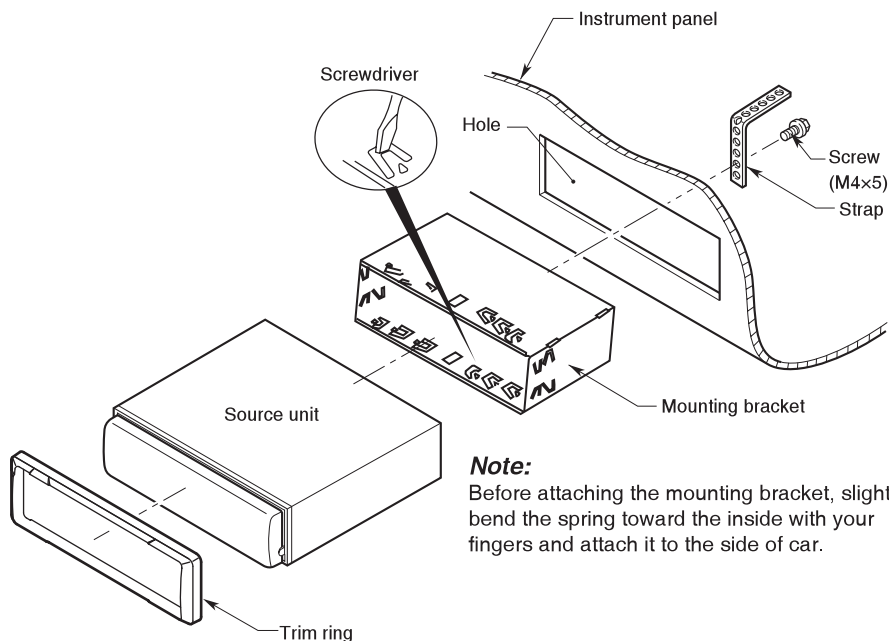

Note:

Before attaching the mounting bracket, slightly bend the spring toward the inside with your fingers and attach it to the side of car.

Method B

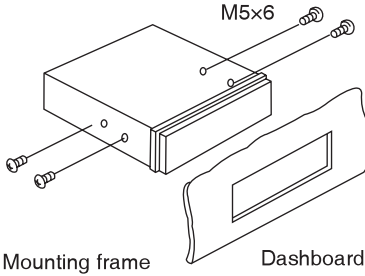
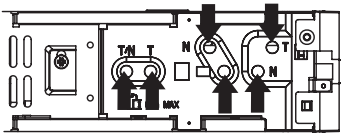

1. Insert this unit directly to the opening of the dashboard.
2. Place M5x6 cylindrical screw through the holes of the mounting frame located inside the opening to holes of the unit and fasten the screws to left & right.

Trim ring installation

Attach the trim ring around the front panel.

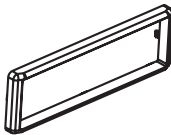

6) Removing the Source Unit

Disassemble trim ring

1. Push the trim ring to right and pull out the right part.

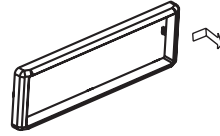

2. Push the trim ring to left and pull out the left part.

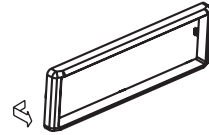

Disassemble the unit

1. Switch off the power.
2. Remove the panel.
3. Remove the trim ring.
4. Insert the removal keys straight back until they lock, then pull the unit out.

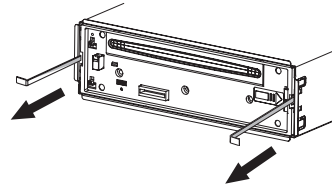

5. Disconnect all the wires.

7) Wiring and Connections

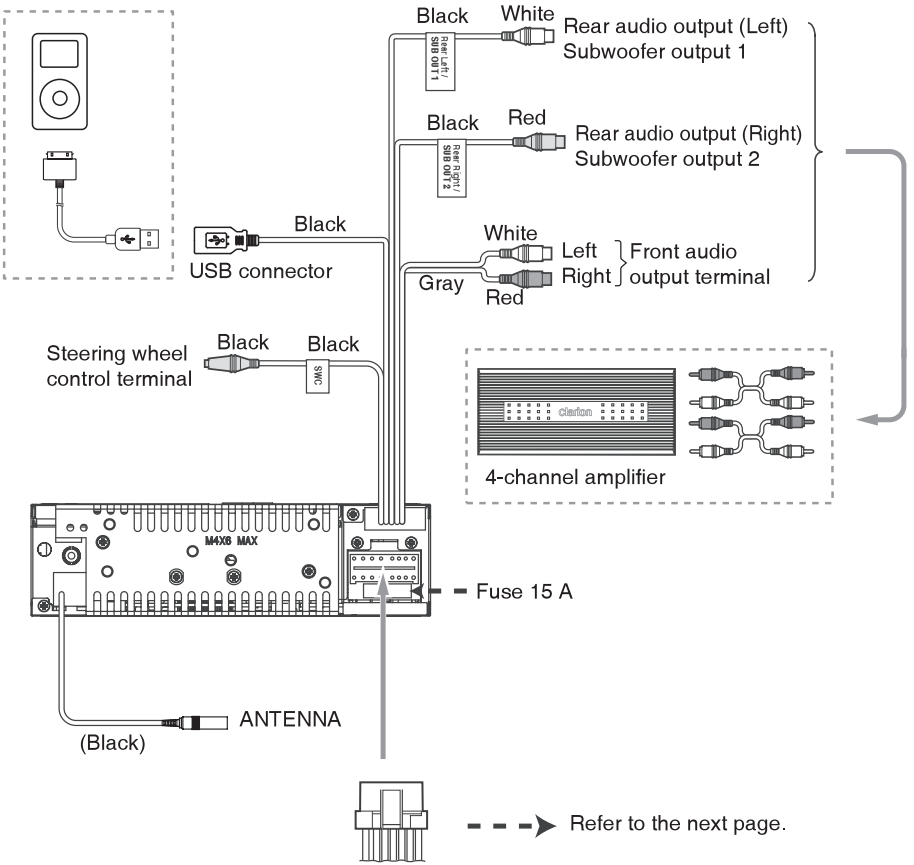

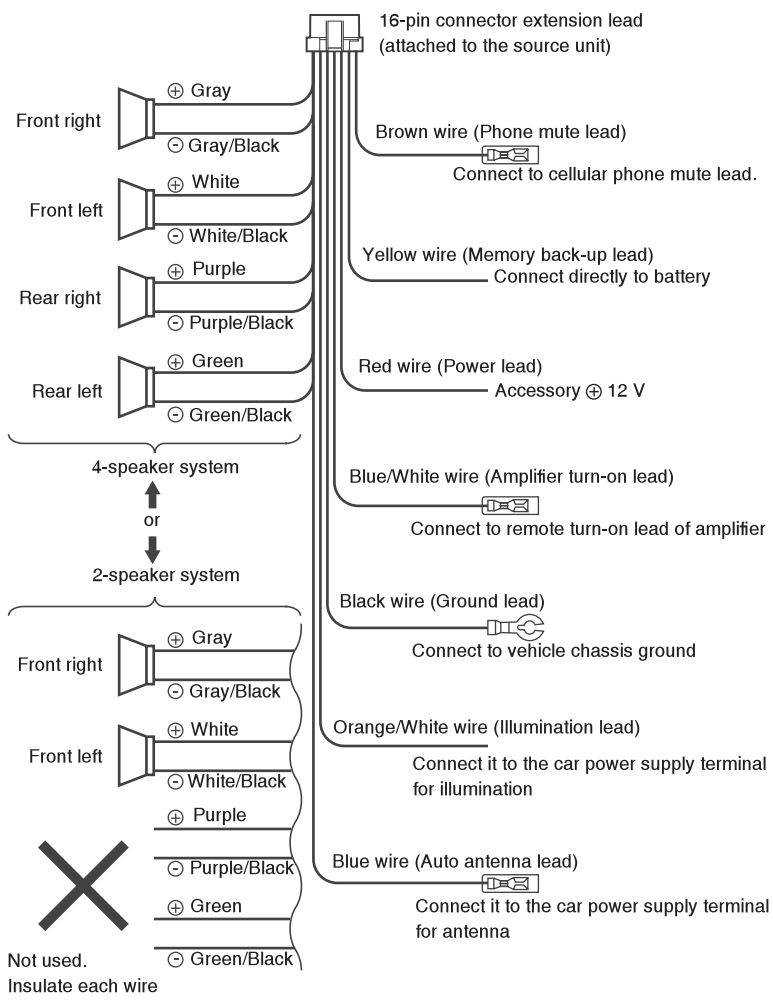

8) Connecting the Accessories

- Connecting to the external amplifier**
 External amplifiers can be connected to the 4 channel RCA output connections. Ensure that the connectors are not grounded or shorted to prevent damage to the unit.

Clarion Co., Ltd.

All Rights Reserved. Copyright © 2010: Clarion Co., Ltd.

PN:127075002529