

# CAR AUDIO AMPLIFIER

---



## MODEL NUMBERS

AZX800M-AZX2002-AZX3002-AZX4800

## **OPERATING INSTRUCTIONS**

PLEASE READ THIS MANUAL THOROUGHLY AND RETAIN IT FOR FUTURE REFERENCE BEFORE OPERATING THE UNITS

## INTRODUCTION

AudioLine Amplifiers provide high-performance sound reinforcement for your mobile audio system.

To achieve optimum performance, it is highly recommended that you read this Owners Manual before beginning installation.

## FEATURES

- POWER SUPPLY CONNECTORS
- ADJUSTABLE INPUT SENSITIVITY: 250mv – 6v
- SHORT CIRCUIT / THERMAL / OVERLOAD PROTECTION
- VARIABLE LOW PASS FILTER & HIGH PASS FILTER
- SOFT DELAYED REMOTE TURN-ON
- RCA LINE AND SPEAKER INPUT
- VARIABLE SUBSONIC FILTER: 15Hz–40Hz.
- BASS EQ SWITCHED: 0dB – 18dB

## WARNING

*High powered audio systems in cars are capable of delivering "Live Concert" high levels of sound pressure. Continued exposure to excessively high volume sound levels may cause hearing loss or damage. Also, operation of a motor vehicle while listening to audio equipment at high volume levels may impair your ability to hear external sounds such as: horns, warning signals, or emergency vehicles, thus constituting to a potential traffic hazard. In the interest of safety, AudioLine recommends listening at lower volume levels while driving.*

## SPECIFICATIONS

AZX 800M	MONO	800 WATTS
AZX 2002	2 X 100 W	200 WATTS
AZX 3002	2 X 150 W	300 WATTS
AZX 4800	4 X 200 W	800 WATTS

### \*NOTICE

- DUE TO VARIABLE FACTORS, POWER RATING MARGIN OF 10% ERROR IS ALLOWED.
- ALL POWER RATINGS ARE TESTED AT 14VDC
- WHEN VEHICLE'S ENGINE IS STOPPED ITS BATTERY'S VOLTAGE DROPS NORMALLY LOWERING POWER RATING INDICATED WITH THIS UNIT.
- WE FOLLOW A POLICY OF CONTINUOUS PRODUCT IMPROVEMENTS AND MODIFICATIONS. DUE TO THIS REASON SPECIFICATIONS, WARRANTIES, FEATURES, PRICES, CONFIGURATIONS AND AVAILABILITIES ARE WITH NO GUARANTEE AND ARE SUBJECT TO CHANGE WITHOUT PRIOR NOTICE



**N1803**

## WARNINGS

- Investigate the layout of your automobile thoroughly before drilling or cutting any holes.
- Take care when you work near the gas tanks, lines, or hydraulic lines and electrical wiring.
- Do not use power amplifier un-mounted. Attach this system securely to the automobile to prevent damage, particularly in the event of an accident.
- Do not mount this system so that the wire connections are unprotected or are subject to pinching or damage from nearby objects.
- The +12VDC power wire must be fused at the battery positive terminal connection.
- Before making or breaking power connections at this system power terminals, disconnect the +12V wire at the battery end.
- Confirm that your radio/cassette player and/or other equip is turned off while connecting the output jacks and speaker terminals.
- If you need to replace the power fuse, replace it only with a fuse identical to that supplied with the system.
- Using a fuse of different type or rating may result in damage to this system which will not covered by the warranty.

## PLANNING YOUR SYSTEM

Before beginning the installation, consider the following:

- a. if you plan to expand your system by adding other components sometime in the future, ensure adequate space is left, and cooling requirements are met.
- b. Are your components matched? The peak power rating of your speakers must be equal or greater than the Amplifiers. They also must be 4-8 Ohms impedance(This information is normally printed on the speaker magnet).
- c. Consider both the length of your leads, and routing when determining the mounting location. Pre-Amp input Jacks require a length of high quality shielded male to male RCA patch cord.

## MOUNTING YOUR AMPLIFIER

The mounting position of your Amplifier will have a great effect on its ability to dissipate the heat generated during normal operation. It has an ample heat sink for heat dissipation, and is also designed with a thermal shut-down ( for heat protection ) circuit, making it reasonably tolerant of mounting variations. Any configuration which allows moving air to be directed over the cooling fins will improve heat dissipation dramatically. DO NOT enclose the amplifier in a small box or cover it so that air cannot flow around fins.

Temperatures in car trunks have been measured as high as 175°F (79.5°C) in the summer time. Since the thermal shut-down point for the Amplifier is 185° F( 85° C), it is easy to see that it must be mounted for maximum cooling capability. To achieve maximum advantage of convection air flow in an enclosed trunk, mount the amplifier in a vertical position, on a vertical surface.

Cooling requirements are considerably relaxed when mounting inside the passenger compartment since the driver will not often allow temperatures to reach a critical point. Floor mounting under the seat is usually satisfactory as long as there is at least 1 inch ( 2cm ) above the Amplifier's fins for ventilation.

- a. Select a suitable location that is convenient for mounting, is accessible for wiring, and has ample room for air circulation and cooling.
- b. Use the amplifier as a template to mark the mounting holes. Remove the Amplifier and drill 4 holes. USE EXTREME CAUTION, INSPECT UNDERNEATH SURFACE BEFORE DRILLING.
- c. Secure the Amplifier using the screws provided.

## WIRING CONNECTIONS

### A. CONNECTING THE POWER

**NOTE:**

**AS A PRECAUTION, IT IS ADVISABLE TO DISCONNECT THE VEHICLE'S BATTERY BEFORE MAKING CONNECTION TO THE +12 VOLT SUPPLY WIRING.**

4/8 GAUGE (Thicker if planning for additional Amplifiers) wire is recommended for both the power and ground wires. 12 Gauge, for the remote turn-on wire. Both types are available at most Mobile Audio Dealers or Installation Shops.

(1) **GROUND:** To Vehicle Chassis

To avoid unwanted ignition noise caused by ground loops, it is essential that the Amplifier be grounded to a clean, bare, metal surface of the vehicle's chassis.

**NOTE:**

**GROUND WIRE SHOULD NOT BE EXTENDED MORE THAN 3 FT. (1 METRE).**

(2) **+12 Volt (Fused) Constant Power:** To Battery (+)

Due to the power requirements of the Amplifier, this connection should be made directly to the positive (+) terminal of battery. For safety measures, install an in-line Fuse Holder (not included) as close to the battery positive (+) terminal as possible with an ampere rating: not to exceed total value of fuses in Amp.

(3) **Remote Turn-On Input:** To Power Antenna output of Car Stereo

This Amplifier is turned "ON" remotely when the vehicles' stereo is turned "ON".

**NOTE:**

**IF YOUR RADIO DOES NOT HAVE A +12VOLT OUTPUT LEAD WHEN THE RADIO IS TURNED ON, THE "RMT" TERMINAL ON THE AMPLIFIER CAN BE CONNECTED TO VEHICLES' ACCESSORY CIRCUIT THAT IS LIVE WHEN THE KEYS "ON".**

**Model AZX800M/AZX3002/AZX4800**

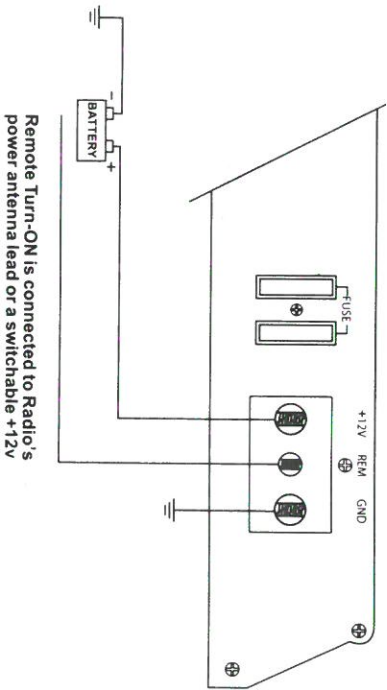

## TROUBLE SHOOTING GUIDE

SYMPTOMS	CHECK POINTS	CURE
NO SOUND	Is the power LED illuminated?	Check fuses in amplifier. Be sure Turn-on lead is connected.
	No power to power wire	Repair power wire or connections
AMP NOT SWITCHING ON	No power to remote wire with receiver on	Check connections to radio
	Fuse broken	Check fuse
	Check Speaker Leads	Inspect for short circuit or an open connection.
NO SOUND IN ONE CHANNEL	Check Audio Leads	Reverse Left and Right RCA inputs to determine if it is occurring before the amp. Check Turner/Deck volume level. Clean contacts on fuse holders.
	Check Mono Bridge and Amp SUBWOOFER Switches	Depress switches to ensure proper position with respect to the installation.
AMP TURNING OFF MEDIUM / HIGH VOLUME	Check speaker load impedance	Be sure proper speaker to ensure impedance recommendations are observed.  (If you use an ohmmeter to Check speaker resistance, please remember that DC resistance and AC impedance may not be the same.)
	Temperature shut down	Turn radio down
PROTECTION LAMP ON	Speaker wires short circuit	Separate speaker wire and insulate



**Model AZX4800**

**a. 4 CHANNEL MODE**

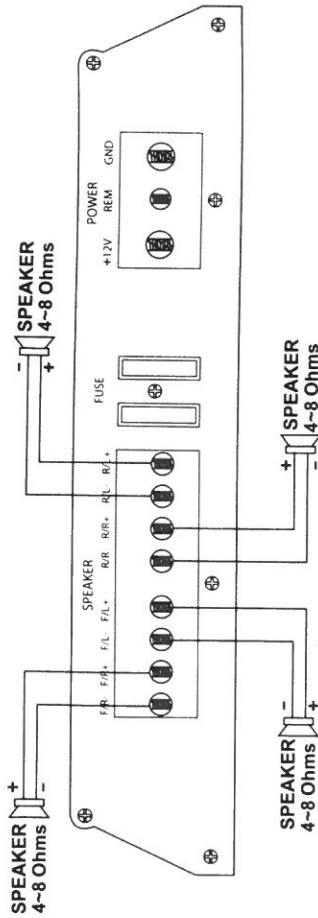

**b. 3 CHANNEL MODE**

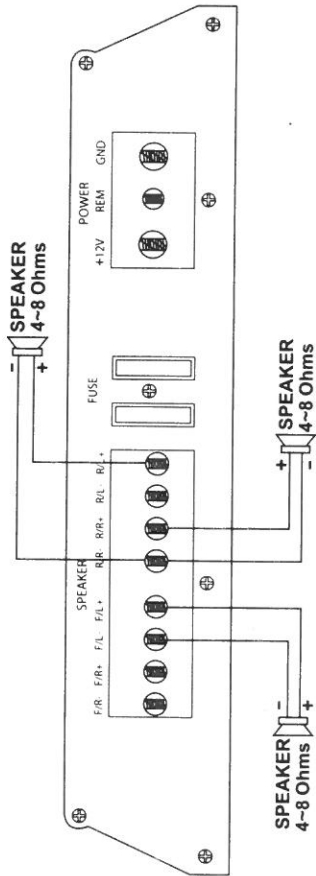

**c. 2 CHANNEL MODE**

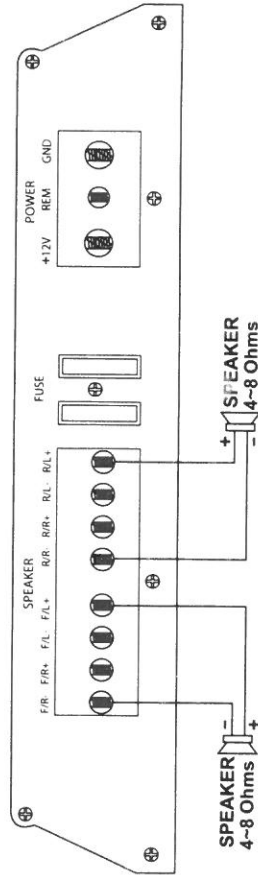

**Model AZX2002**

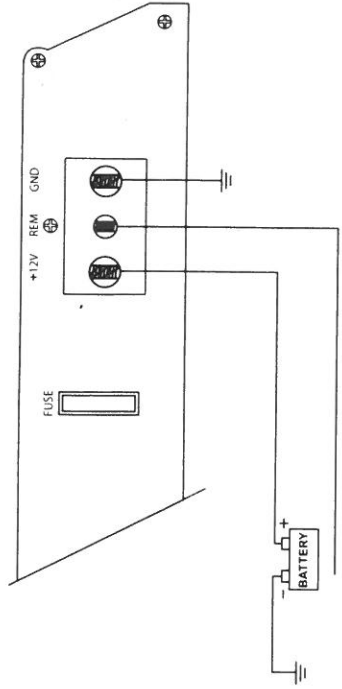

Remote Turn-ON is connected to Radio's power antenna lead or a switchable +12v

**B. VARILABLE LOW-PASS FILTER ( 50Hz-250Hz )**

For use as a dedicated Subwoofer Amplifier, as desired. This activates the Low-Pass filter circuitry, thus allowing only frequencies below these settings to be amplified. For normal full-range frequency speaker configuration, set to "OFF".

**C. VARILABLE HIGH-PASS FILTER ( 50Hz-250Hz )**

For use as a dedicated Subwoofer channel, set filter switch to "HPF". Adjust variable crossover frequency with control as desired. The amplifier input circuit filters out everything above 50-250Hz (dependent on the adjustment of the frequency control), so only the deepest bass notes are amplified.

**D. BASS BOOST**

By using the bass boost function deepest bass notes at 45Hz are emphasized.

**E. CONNECTING HIGH LEVEL INPUTS**

**NOTE:**

**DO NOT USE IN CONJUNCTION WITH LOW LEVEL INPUT JACKS.**

**Model AZX2002/AZX3002**

- RED : Connect to Right(+)Speaker Output of Car Stereo
- GRAY : Connect to Right(-)Speaker Output of Car Stereo
- GREEN : Connect to Left(+)Speaker Output of Car Stereo
- YELLOW : Connect to Left(-)Speaker Output of Car Stereo
- BLACK : Connect to Car Stereo Ground Wire

**Model AZX2002**

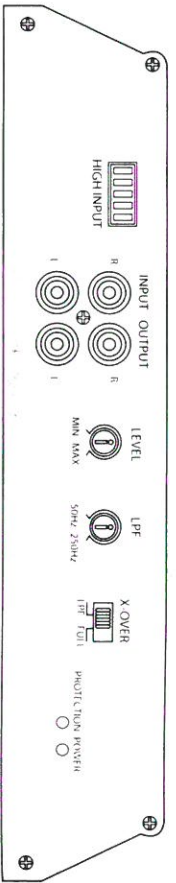

**Model AZX3002**

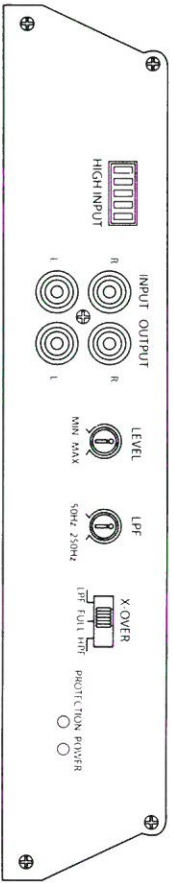

**Model AZX800M**

RED : Connect to (+) Speaker Output of Car Stereo  
 YELLOW : Connect to (-) Speaker Output of Car Stereo  
 BLACK : Connect to Car Stereo Ground Wire

**Model AZX800M**

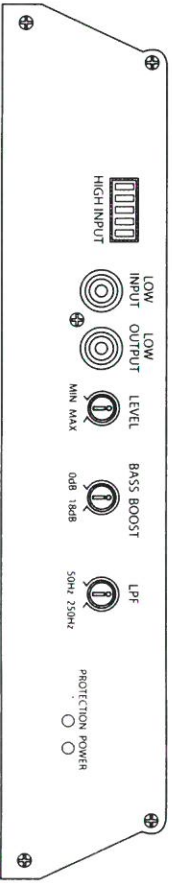

**Model AZX2002**

**a. 3 CHANNEL MODE**

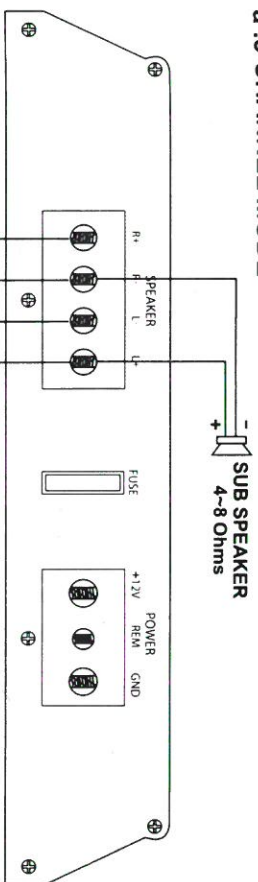

**b. 2 CHANNEL MODE**

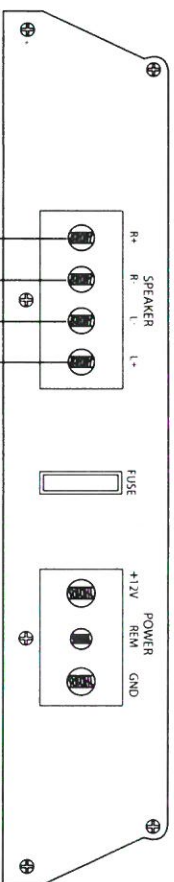

**Model AZX3002**

**a. 3 CHANNEL MODE**

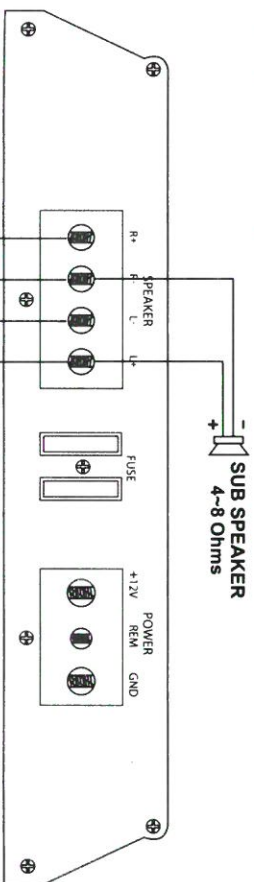

### Model AZX3002

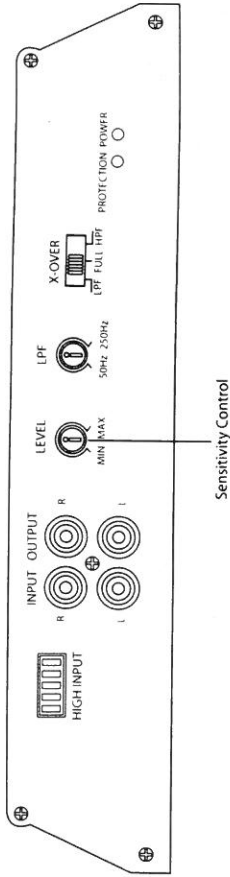

### Model AZX4800

- RED : Connect to REAR RIGHT(+) Speaker Output of Car Stereo
- GRAY : Connect to REAR RIGHT(-) Speaker Output of Car Stereo
- BLACK : Connect to Car Stereo Ground Wire
- GREEN : Connect to REAR LEFT(+) Speaker Output of Car Stereo
- YELLOW : Connect to REAR LEFT(-) Speaker Output of Car Stereo
- RED : Connect to FRONT RIGHT(+) Speaker Output of Car Stereo
- GRAY : Connect to FRONT RIGHT(-) Speaker Output of Car Stereo
- BLACK : Connect to Car Stereo Ground Wire
- GREEN : Connect to FRONT LEFT(+) Speaker Output of Car Stereo
- YELLOW : Connect to FRONT LEFT(-) Speaker Output of Car Stereo

#### CAUTION:

**NOTE THAT ONLY POSITIVE (+) WIRES ARE USED. DO NOT CONNECT SPEAKER NEGATIVES (-) FROM CAR STEREO. INSULATE ANY BARE WIRES.**

### Model AZX4800

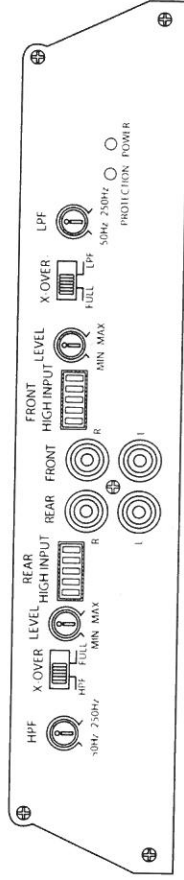

## CONNECTING THE SPEAKERS

### Model AZX800M

#### a. MONO MODE

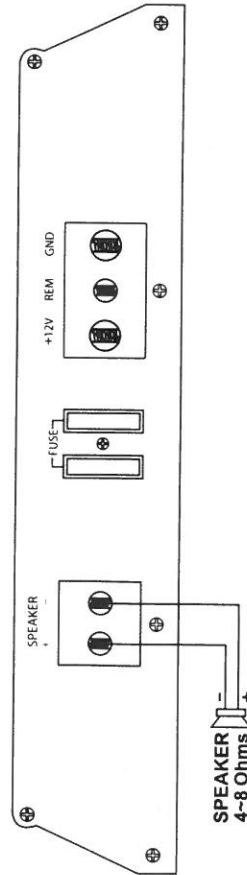

**F. CONNECTING LOW LEVEL INPUTS (RCA jacks)**

**NOTE:**  
**DO NOT USE IN CONJUNCTION WITH HIGH LEVEL INPUT WIRES.**

- Wire routing is **CRITICAL** for **NOISE FREE PERFORMANCE**. Observe the following:
1. Always use high quality RCA type shielded cables.
  2. Always use the shortest length possible. If the cable is too long, make an "S" type loop (not a coiled loop) in the center of the cable to take up any excess.
  3. Never cut the shielded cable and re-splice it.
  4. Never route any Amplifier input cables near or parallel to speaker outputs, high energy ignition wires, or rear computer controlled ignition circuit units (Computer units may be found behind or under the dash panel in late model cars).

**POWER INDICATOR LED**

This **GREEN LED** will illuminate when the amplifier is turned "ON". If it fails to illuminate, check the power connections to the Amplifier and fuses.

**PROTECTION CIRCUIT**

Should the Amplifier be "SHORT CIRCUITED" overloaded or overheated, the protect circuit will "SHUT-DOWN" the Amplifier

**CAUTION:**

**THIS AMPLIFIER IS DESIGNED TO OPERATE WITH A MINIMUM LOAD IMPEDANCE OF 2 OHMS IN STEREO, OR 4 OHMS IN MONO (BRIDGED, MULTI-MODE) CONFIGURATIONS. SUBJECTING TO IMPEDANCES LOWER THAN RECOMMENDED, MAY CONSTITUTE TO POTENTIAL DAMAGE TO THE MOSFET POWER SUPPLY. FOLLOW INSTRUCTIONS ON SECTION "I", WIRING CONNECTIONS" FOR FURTHER INFORMATION.**

**INPUT SENSITIVITY (LEVEL) CONTROL**

In order to achieve maximum signal-to-noise performance, this control adjusts the signal level from your Car Stereo/source, to match the Amplifier's sensitivity. It is **NOT** a volume control.

- To adjust, proceed as follows:
- a. Set **INPUT LEVEL** Control at mid-point.
  - b. Listen for audible distortion as you increase the Car Stereo **VOLUME** control. If none is heard, turn the adjustment level control toward "MAX" in stages, until the onset of audible distortion is heard, then decrease to level prior to the immediate point of audible distortion.
  - c. If distortion is immediately heard, turn control toward "MIN" until the sound is clear.

**NOTE:**

**NOT PERFORMING ABOVE ADJUSTMENT PROCEDURE AND/OR SIMPLY SETTING THIS CONTROL AT OR NEAR "MAX" POSITION, MAY INDUCE ELECTRICAL AUDIO NOISE INTO THE SYSTEM.**

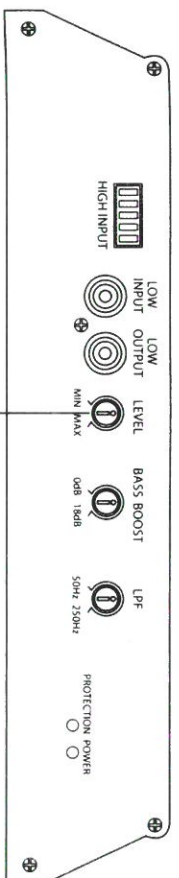

**Model AZX2002**

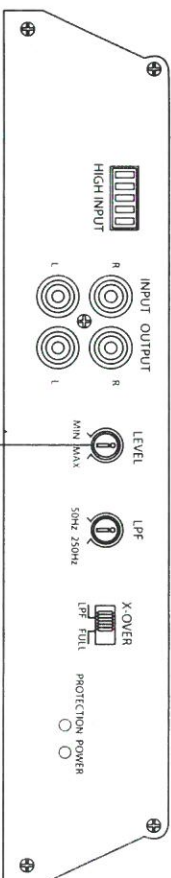

**Model AZX4800**

