

USER MANUAL

Model FP9670

TO SUIT TERRITORY

SZ MK2

Inclusions

- 1x Black (Piano) double DIN facia kit
- 1x Built-in HVAC & steering wheel control unit
- 1x Universal SWC patch lead
- 1x Subwoofer retention
- 1x Antenna adapter
- 1x Chime retention
- 1x Mounting kit

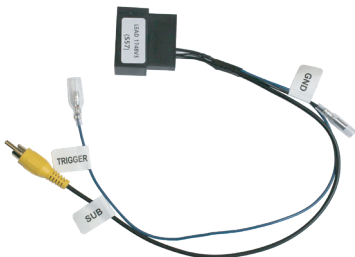
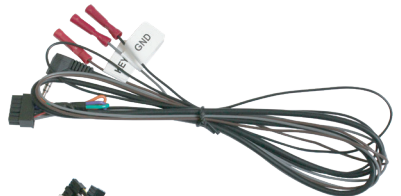
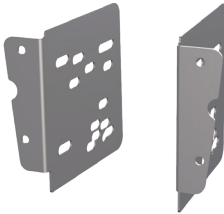

Infodapter Controls

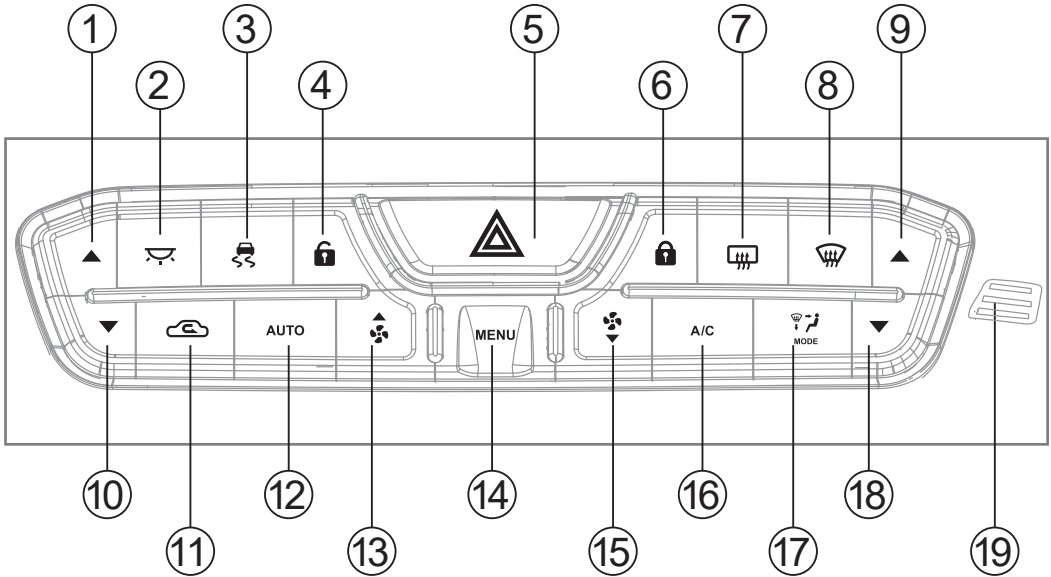

Steering Wheel Controls

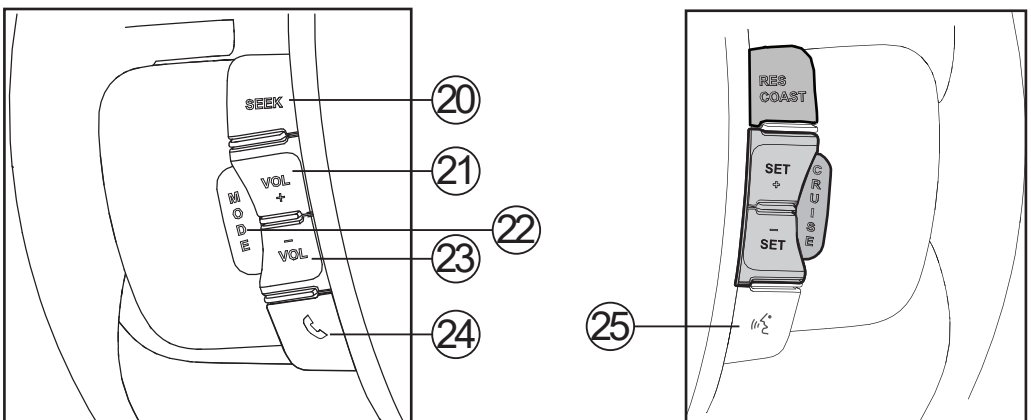

Button Functions

- | | | |
|---|--|---|
| 1. Temperature UP
(Passenger side) | 9. Temperature UP
(Drivers side) | 17. Mode |
| 2. Interior light ON/OFF | 10. Temperature DOWN
(Passenger side) | 18. Temperature DOWN
(Drivers side) |
| 3. Dynamic stability
control ON/OFF | 11. Air circulation | 19. Temperature Sensor |
| 4. Door unlock | 12. Auto climate control | 20. Seek |
| 5. Hazard button | 13. Fan speed | 21. Volume UP |
| 6. Door lock | UP/ Menu Navigation | 22. Mode |
| 7. Rear demister
(Push & hold for
parking aid activation
and deactivation) | 14. System menu | 23. Volume Down |
| 8. Front demister | 15. Fan speed
DOWN / Menu Navigation | 24. Phone (No longer retained) |
| | 16. Air conditioner
ON/OFF | 25. Voice Command button
-Short press to answer.
-Long press to hang up |

NOTE: *The voice command button has be re-assigned to answer and hang up calls*

NOTE: The Infodapter video output is NTSC by default.

Interface Functions

Front Demister

Fresh air is blown through the heater core and then ducted to and distributed over the interior surface of the vehicles windshield

BUTTON



SCREEN DISPLAY

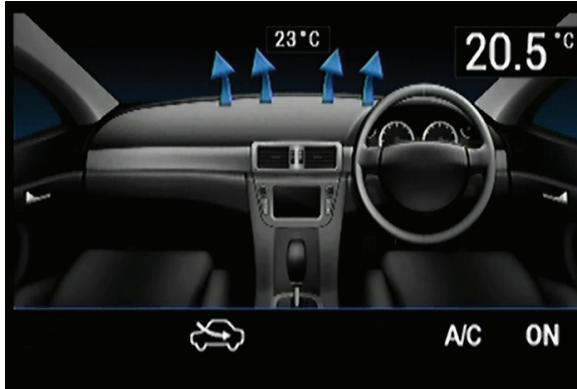

MFD



Rear Demister

The demister clears condensation from the rear window

BUTTON

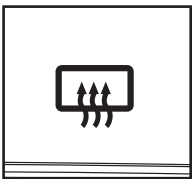

SCREEN DISPLAY



MFD

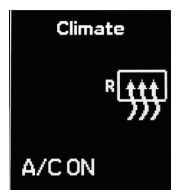

Push & Hold
to activate and
deactivate
parking aid



Interface Functions

Air Circulation Mode

Changes between fresh air drawn in directly from the outside of the vehicle, or recirculation where the air is drawn from inside the cabin

BUTTON



SCREEN DISPLAY



MFD

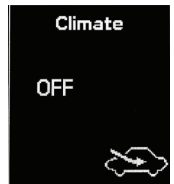

Interface Functions

Mode

Changes the vent positions for heating and cooling

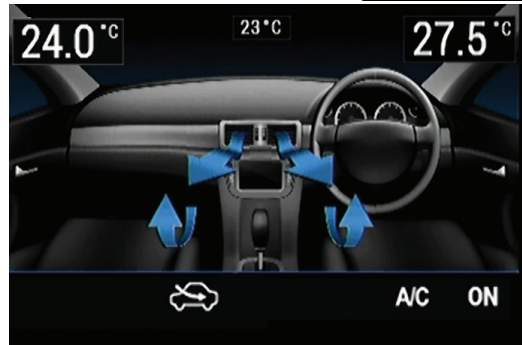
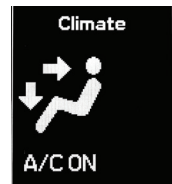
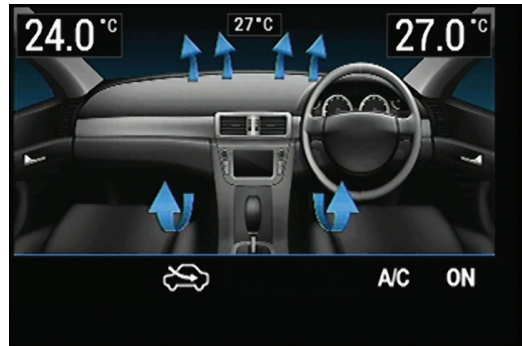
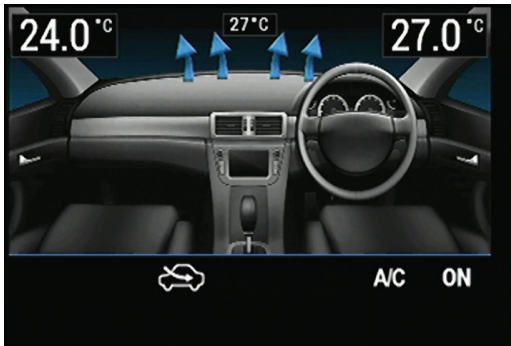
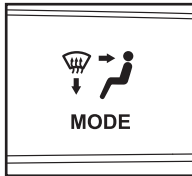

Interface Functions

Heating & Cooling Temperature

To increase temperature press up, to decrease temperature press down. Left hand side buttons adjust passenger side temperature settings. Right hand side buttons adjust drivers side temperature settings. Push & hold the **Auto** button to reset back to single zone. External temperature icon is in the top middle

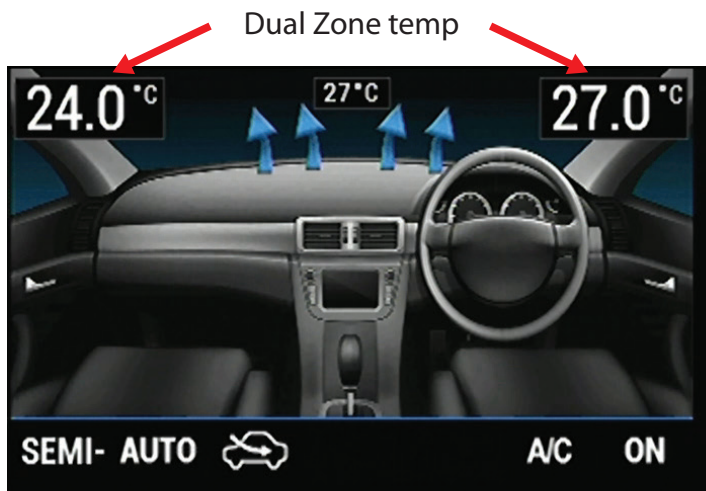
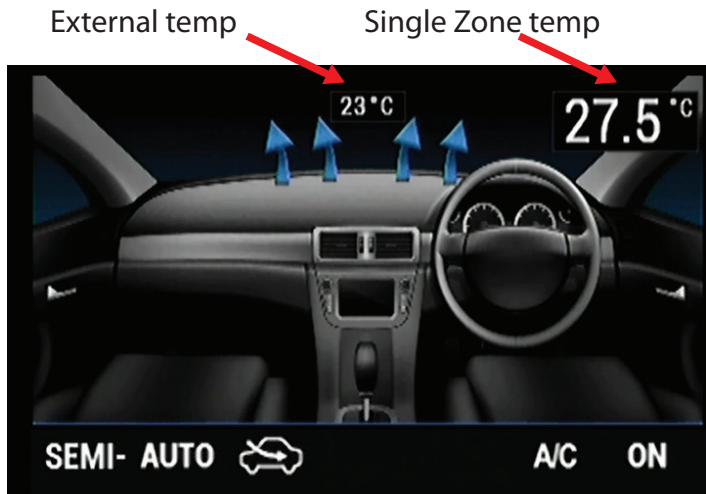
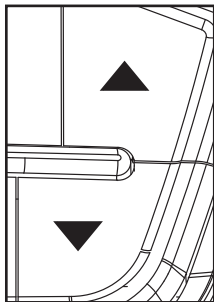

Interface Functions

Air conditioning On or Off

Press to turn the air conditioning On/Off or vice versa. This can be changed and reversed in the setup menu. **Note:** *Holding down the A/C button completely turns the A/C heating and cooling system Off.*

BUTTON

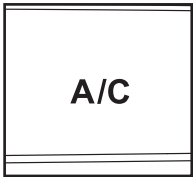

SCREEN DISPLAY



MFD

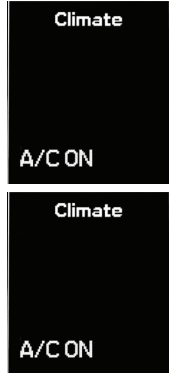

Fan Speed Adjustment

Pressing these will turn the fan speed up and down. **Note:** *Adjusting fan speed will also switch from auto to semi-auto climate control.*

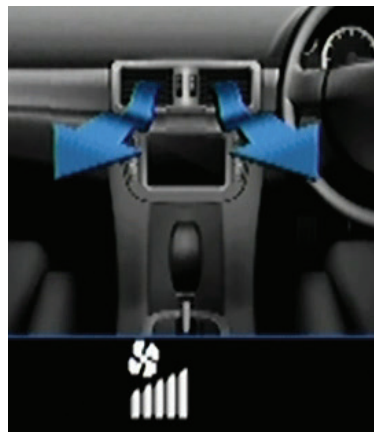
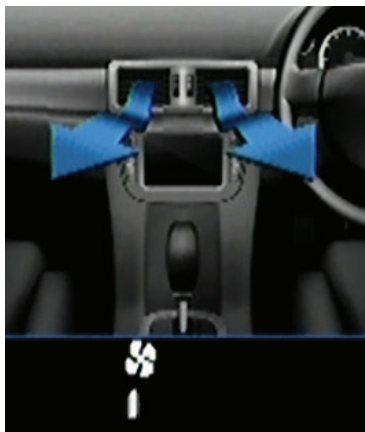
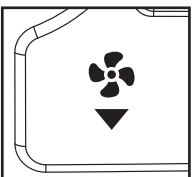
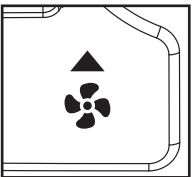

Interface Functions

Auto Function

Press to automatically set the climate control to maintain a specified temperature.

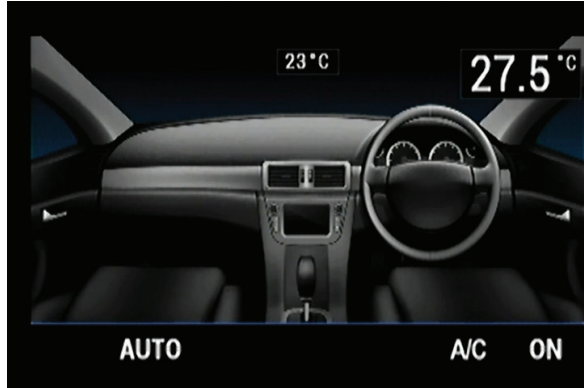

Auto Function (Semi Auto)

Adjusting the fan speed will also switch from auto to semi-auto climate control.

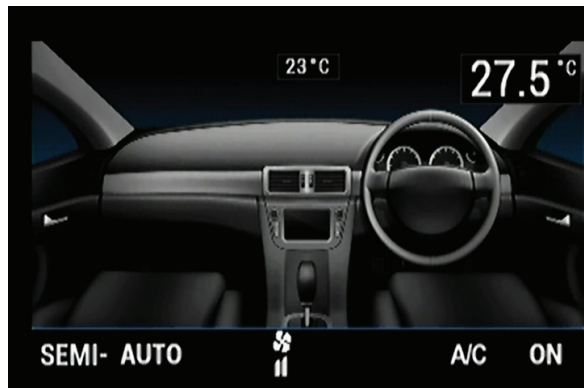

Interface Functions

Door Unlock/Lock

Press to lock and unlock all doors in the vehicle



Dynamic Stability Control

Press to turn Dynamic Stability Control (vehicles traction control) on or off.



Interior Light

Press to turn the vehicles factory interior light on or off

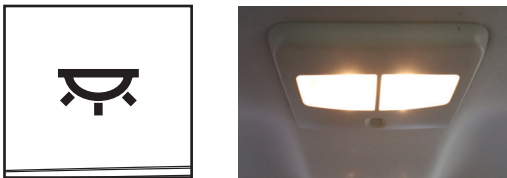

Hazard Flasher Warning Light

Press to turn the vehicles hazard emergency light on or off



Menu Functions

Configuration Menu

Press and hold the menu button for a few seconds to display the Configuration Menu. Press the Fan UP/DOWN buttons to navigate up and down between sub menus. Press menu button to enter into sub menus and again to change settings.

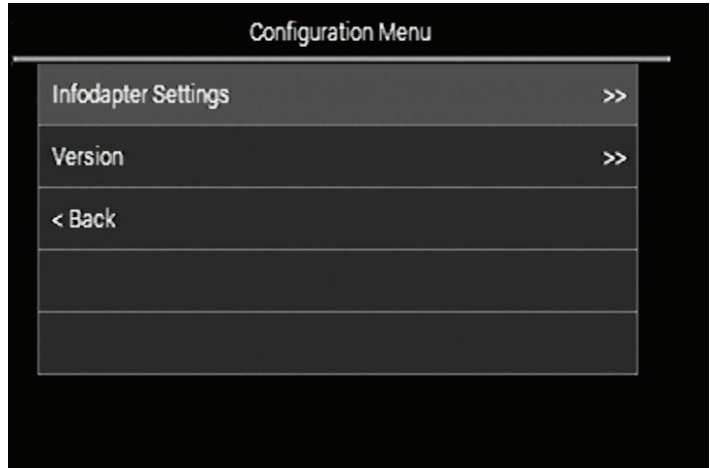
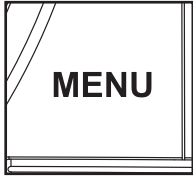

Menu Functions (Infodapter Settings)

Select Infodapter Settings/Preferences to access sub menus.

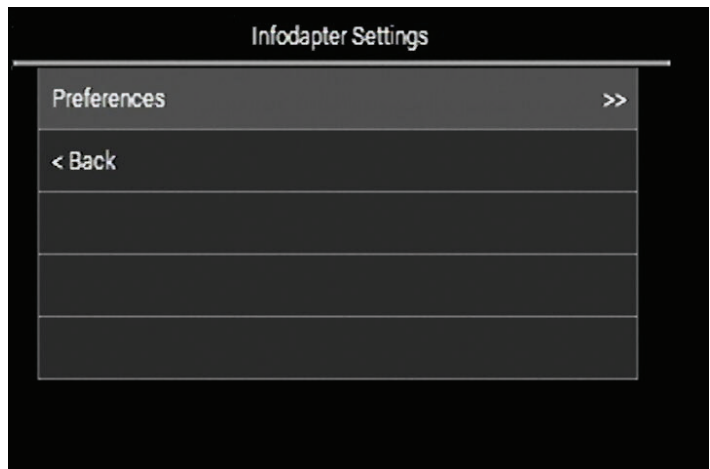

Menu Functions (Infodapter Settings Continued)

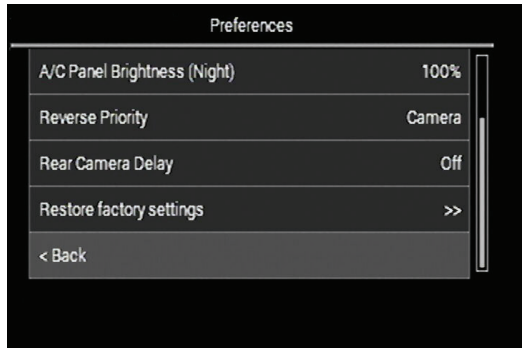
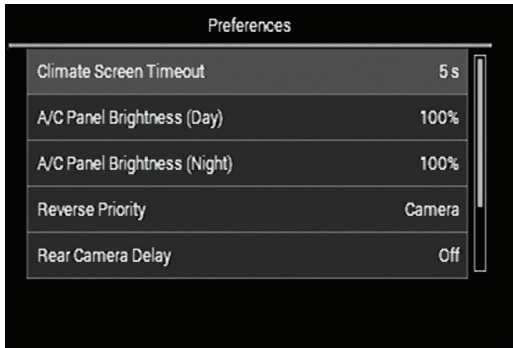

Climate Screen Timeout

Adjusts the time it takes the Infodapter screen to return to the Headunit Screen, by pressing the fan Up & Down buttons, select between 3 - 30 seconds

A/C Panel Brightness (Day mode)

Adjusts the brightness of the LED's on the Infodapter, by pressing the fan Up & Down buttons, select between 5% - 100%

A/C Panel Brightness (Night mode)

Adjust the brightness of the LED's on the Infodapter, by pressing the fan Up & Down buttons, select between 5% - 100%

Reverse Priority

Allows the selection of either the camera video feed or the park assist image when the vehicle is in reverse. Switchable via steering wheels **MODE** button. (Only appears in the menu if the camera connection setting is turned ON)

Rear Camera Delay

The camera image is displayed upon shifting out of Reverse (R) until the vehicle speed reaches 8 km/h. This occurs when the rear camera delay feature is on.

Restore Factory Settings

Restore all infodapter settings to default

Menu Functions (Infodapter Settings)

Installer Menu

When in the Configuration menu, press and hold the fan **UP & DOWN** buttons at the same time to access the installer menu

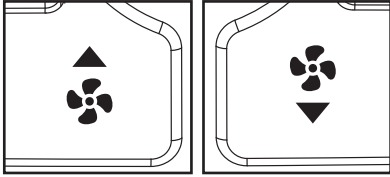

Air Conditioner Type

Choose between a single or dual climate system. *Note: Dual climate systems can run as a single zone system*

Menu Functions (Infodapter Settings)

Screen Size/ Position

Allows the user to change the Infodapter screen to fit to your headunits display

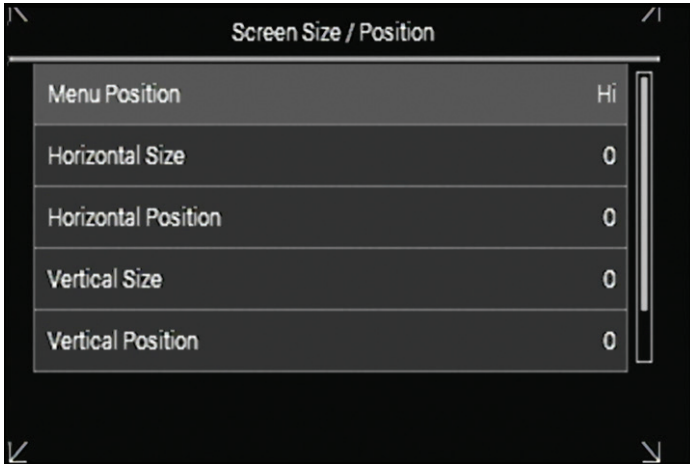

Camera Connected

Turns the reverse camera function On or Off. **Note:** must be set to “Yes”

Diagnostics

Information on the system to check the vehicle is communicating with the Infodapter

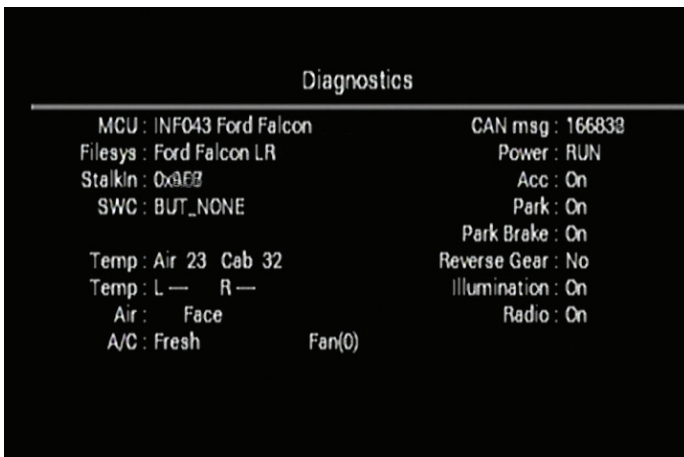

INSTALLATION MANUAL

Model FP9670

TO SUIT **TERRITORY**

SZ MK2

Tools Needed

Use the following tools to make dismantling the car and the installation of the new facia easier

1. Panel Remover



2. Phillips Head Screwdriver

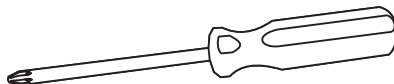

3. Socket - 7 & 8 mm

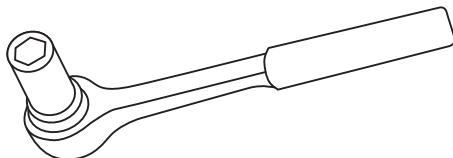

4. Side Cutters

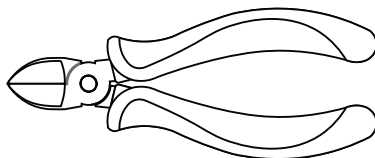

5. Small Pick



6. Cable Ties

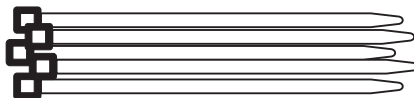

7. Electrical Tape

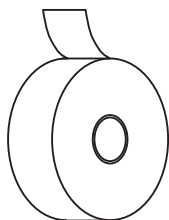

Centre Console Disassembly

Eject any compact disks that may still be in the factory unit.

Remove the rubber coasters at the base of each cup holder to reveal Philips head screws and remove them. Once the screws are removed, the cup holder will lift out of place.

The trim around the gear shift lever follows. This trim piece is clipped into place and can be removed by applying gentle and even pressure with a panel removal tool.

Move the gear shift lever down to the "D" drive position.



Centre Console Disassembly

Firmly pull the storage compartment outward towards you. Once unclipped, disconnect the wiring harness for the accessory socket, take out the pocket, and place it aside.



OEM Headunit Removal

Removing retaining bolts

Using a 7mm socket driver or ratchet, remove the 2 short bolts at the back and an 8mm socket for the two long bolts on the sides to loosen the factory unit at the bottom.

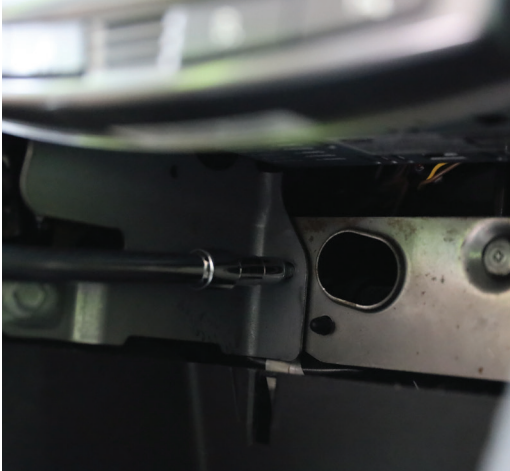

OEM Headunit Removal

Removing top panel trim

Using a flat pry tool, carefully lever the top panel up at the side and remove.



Removing fascia

Remove the two 7mm bolts at the top and unplug the OEM monitor connectors.

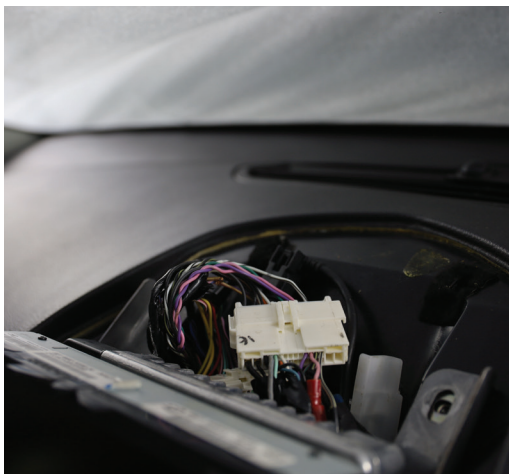

OEM Headunit Removal

Holding the factory unit at the top and bottom, pull the unit back towards you to remove.

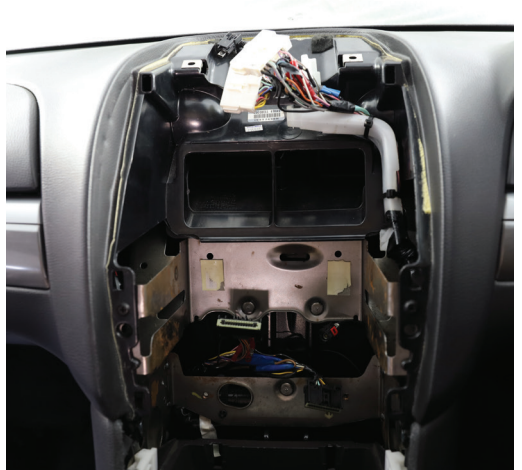

OEM Headunit Disassembly

Removing factory headunit face plate

Place the unit on a soft surface to remove the screws holding the left & right side brackets on.

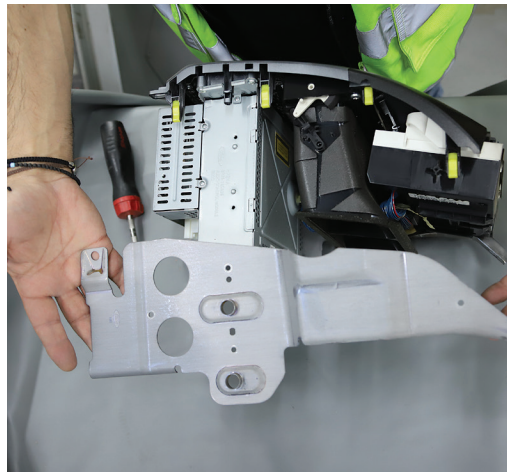
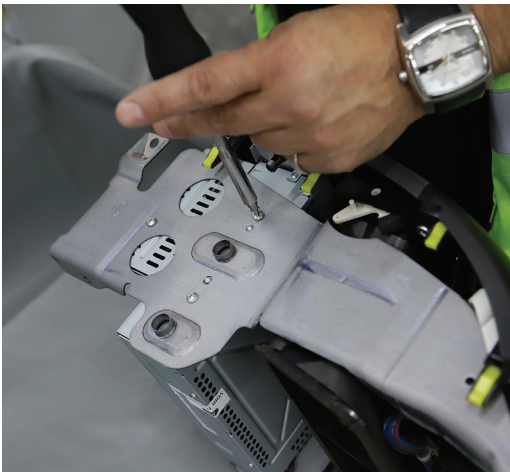
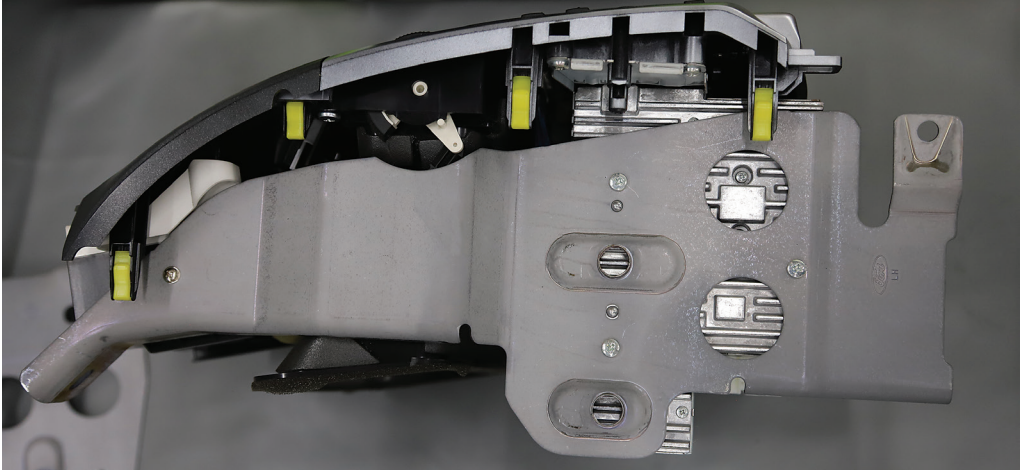

OEM Headunit Removal

Undo the 3 screws holding the factory vent in place. Put aside screws to be reused.



OEM Headunit Disassembly

Remove the cable from the retaining clip on the side of the vent. Remove the vent and put aside.

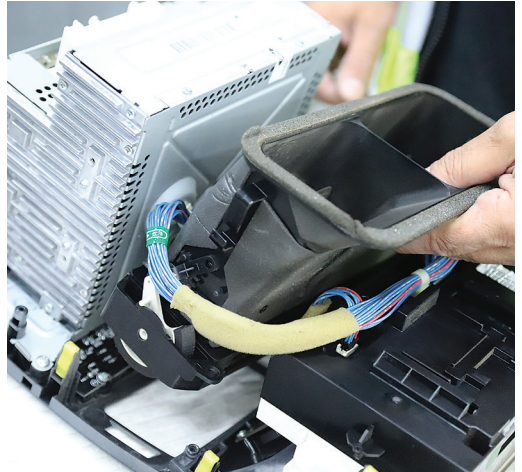

Changing The Dip Switch

DIP switches can be changed to match the headunit and rear camera being used with this installation kit. Make these changes before installing the kit. Check the rear camera and steering wheel control requirements for your devices.

Step1. Access the DIP switches via the cutout on the back of the Infodapter

Step2. Using a pick tool, flick the switches to the required setting

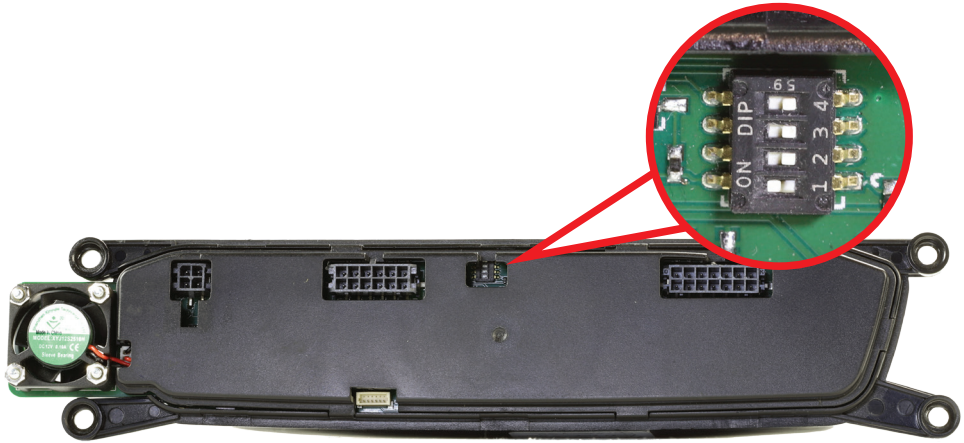

Dip Switch Settings

Up = On, Down = Off

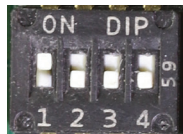

- 1: Pioneer & Sony code change. Dip 1 is ON for Pioneer models, Dip 1 is OFF for Sony models. Check your headunits menu first to make sure the steering wheel controls are activated. Refer to page 2-19 of this manual for more information. Default is ON for most other models.
- 2: Setting for reverse camera. ON = PAL, OFF = NTSC. The default setting is OFF (NTSC).
- 3: Resets the display settings back to default. If the display settings have been manipulated in a way that it is no longer possible to make adjustments, change the DIP switch #3 from OFF to ON and back. This will reset the screen settings to the factory defaults. During this procedure the screen background will change to red. While the background is red, no settings can be made.
- 4: Not applicable

Vent Assembly

Reattaching the vents

Place the new kit, face down on a soft surface. Place the factory vent into position and secure using the 3 screws retained earlier.



Headunit Assembly

Attach the metal brackets supplied to the facia using the four supplied screws.

Place the headunit into the mounting brackets and loosely attach with screws on either side. Adjust the headunit to the desired depth before tightening the mounting screws on both sides.

Adjust the headunit to the desired depth before tightening the mounting screws on both sides.

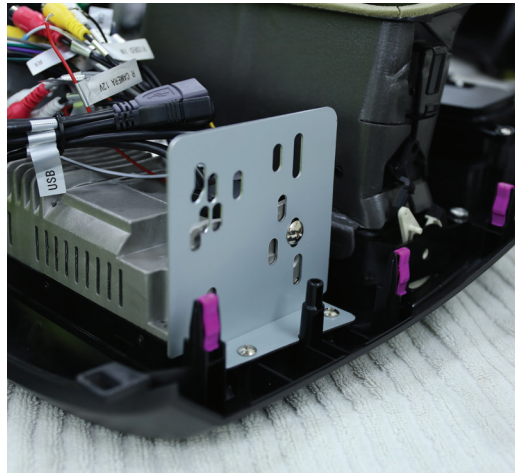
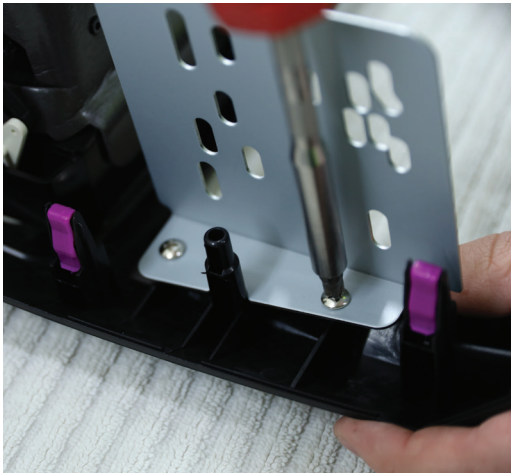

Headunit Assembly

Connect the main harness to the control unit. The wires can be routed up through the cable management clip on the vent.

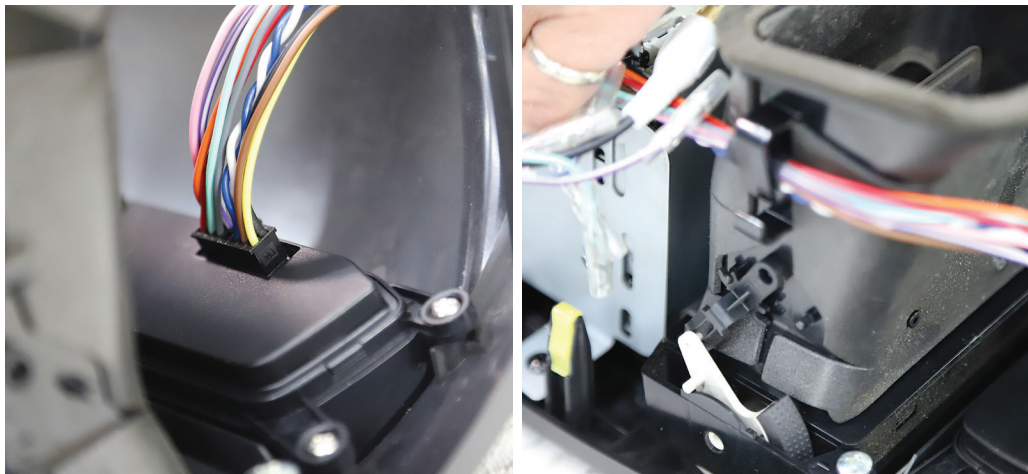

Connect the 4 pin video plug, and connect the yellow RCA plug to the reversing camera input on the aftermarket head unit. Connect the purple reverse output wire to headunit reverse trigger. This will allow the climate controls to display on the aftermarket head unit. The reversing camera wiring must be completed between the facia and the aftermarket radio. Otherwise the vehicle's display will not show on the aftermarket screen. The female yellow RCA socket connects to the reverse camera.

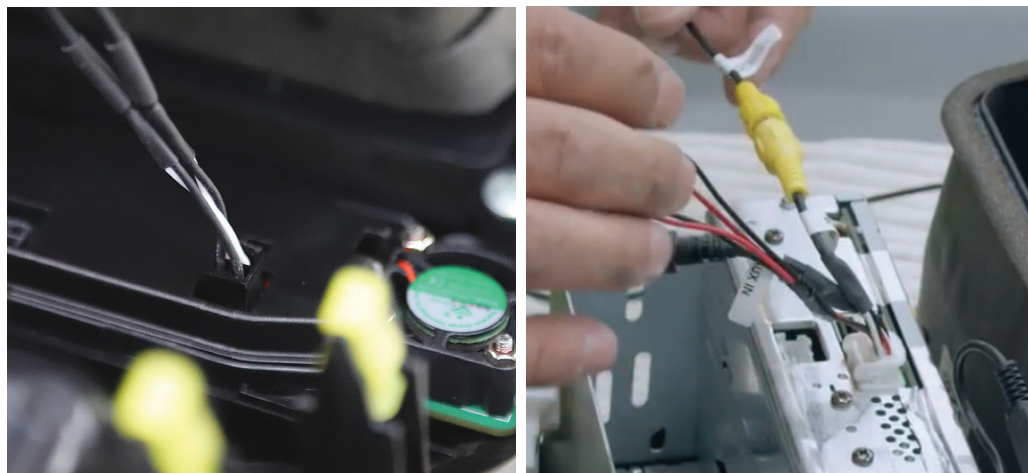

Headunit Assembly

Connect the SWC patch lead, making sure it is in the correct configuration for your brand of headunit.

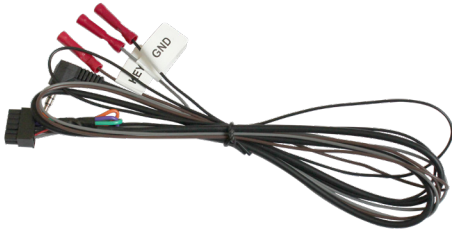

Plug the other end of the SWC patch lead into the aftermarket headunit's steering wheel remote input. Connect the brand specific secondary harness (Aerpro App8 series sold separately) into the aftermarket headunit. **NOTE:** It is important to connect brand specific or correctly modified universal patch lead to module before powering up.

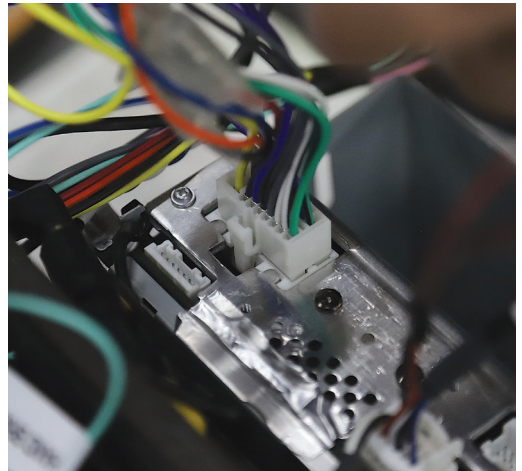

Headunit Assembly

Connect the ISO connectors from the main harness to the secondary harness. Connect any other cables like park brake, reverse and speed pulse if available. Tape up any unused cables. Tape up the now obsolete plug at the top so it does not rattle around.

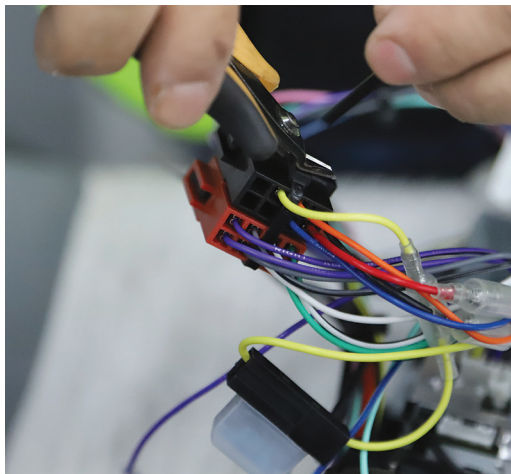

OEM Reverse Sensor

Retaining the OEM reverse sensor alerts

Connect the reverse sensor module to the main harness then connect the 2 pin speaker connector. Securely mount the module and speaker in an appropriate position.

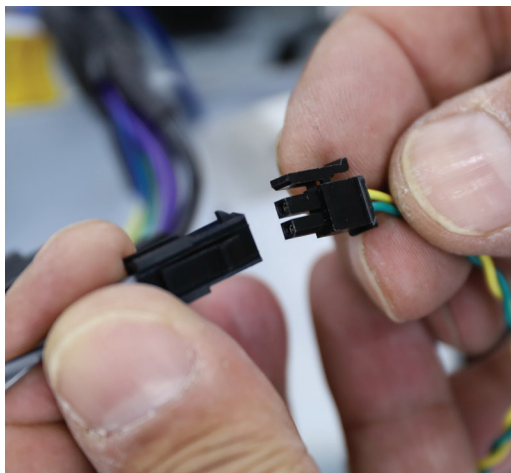

Headunit Assembly

Plug the main harnesses and antenna adapter into the vehicle. Place the entire unit into the vehicle resting at the top, making sure all of the cables are out of the way. Gently push the unit into place.



Switch the vehicle to ignition and test all functions such as steering wheel controls, audio, illumination of the HVAC buttons, and climate controls. Once all functions have been tested successfully, re-install the centre console in the reverse order of removal.



Wiring diagram

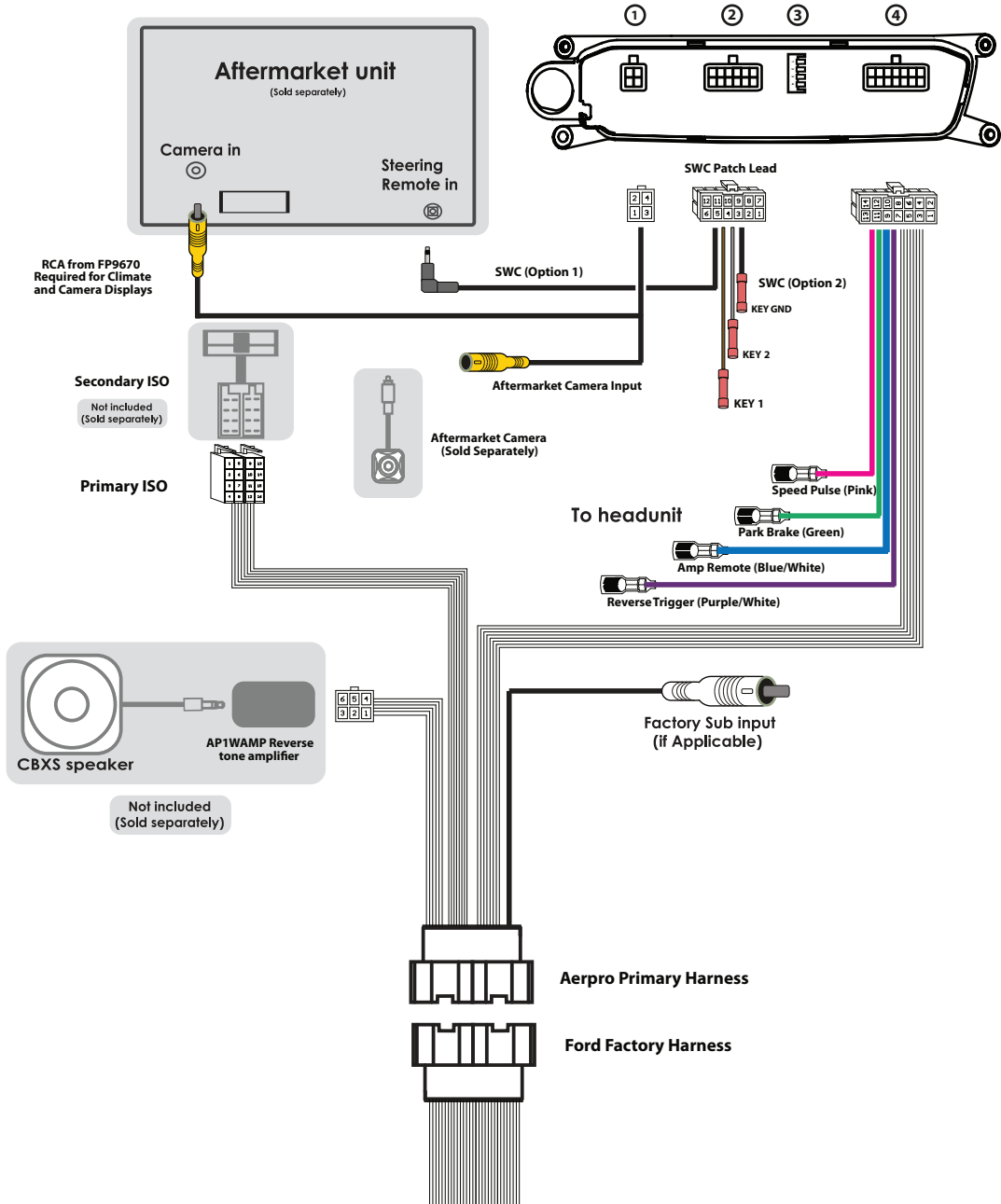

SWC Patch Harness Configuration

SINGLE WIRE INPUT

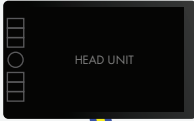

Radios such as Kenwood, JVC and Grundig have single wire input. Use this connection first and cut loops accordingly. Ensure the Radio manual is checked for this cable before proceeding.

LEARNING RADIOS

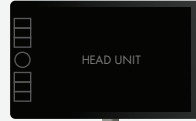

Radios with 3 wire learning will require all three Key wires connected, then programmed in the radios menu. Check Radio manual for before proceeding.

3.5MM JACK INPUT

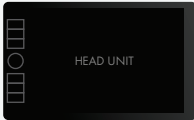

Radios with a jack input ONLY, such as Sony and Pioneer will utilise this connection. Some learning radios will use this connection for programming, these radios should have all coloured loops connected.

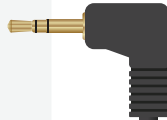

SWC 1 SWC 2 GND

SWC 1 SWC 2 GND

Radios with 3 wire systems may label wires differently. KEY, SWC, Remote ETC.

APUNIP12



Radios with multiple connections, ie Jack and wire input, only use one connection. For more detailed instructions, please follow the QR code.



Always remember to insulate any unused connections



Aerpro, Sany, Pioneer & Other Radios with Learning Ability
No Loops Cut



Alpine
Cut Green



Clarion
Cut Purple



JVC
Cut Purple & Green



Grundig, Philips, Nakamichi
Cut Purple & Orange



Kenwood
Cut Green & Orange

SWC Patch Harness Configuration

Kenwood/JVC: Some Kenwood and JVC radios have 2 steering control inputs. A 3.5mm socket (Remote IN) and Blue with Yellow trace wire. To send direct translated codes to your Kenwood/JVC radio, configure the patch lead up as Kenwood or JVC outlined in the configuration assignments and connect the Brown patch lead wire (KEY 1) used. If you would like to be able to program your steering controls configure the patch lead as Self Learn and plug the 3.5mm Jack into the Remote IN of the Kenwood/JVC, disregard the Brown wire.

Pioneer : Some Pioneer models require the steering controls to be enabled they will by default OFF. These steering control settings are located in the system settings of the radio can only be accessed whilst the unit is in standby mode and the park-brake wire is connected (if applicable). Please refer to your Pioneer manual on exact methods for enabling steering controls.

Sony: Recent Sony models may give you incorrect SWC button results after installing a control harness. This is due to a slight change in input codes on the newer Sony radios. To resolve this please do the following steps:

- Remove the steering control harness from the vehicle.
- Remove the plastic casing from the black steering control box.
- Locate the very small dip switch selector on the board
- Turn dip switch 4 OFF.
- Re-assemble and test.

There is also some Sony radio's that default steering controls off. If you are receiving no steering control functions at all please refer to your Sony manual on how to enable steering controls.

General: Please ensure all connections to your aftermarket head unit (including patch lead modification) are completed before power is provided to the harness. Some of our control harnesses work by translating the vehicles CANBUS data and can only start this process on ignition. If you find that you are not getting any response from your steering controls on accessory (single key click) please re-test on ignition.

Note: The steering controls must be working in the vehicle previously to work with our control harnesses. They will not fix a previous underlying problems.

Technical assistance

If you need assistance setting up or using your Aerpro product now or in the future, call Aerpro Support. Australia

TEL: 03 – 8587 8888

FAX: 03 – 8587 8866



Mon-Fri 9am – 5pm AEST

Please retain this user guide for future reference.

This manual is considered correct at time of printing but is subject to change. For latest manuals, updates and video installation guide refer to the website.

If you would like to find more information on this product or download an up to date digital copy of this manual, please visit the <https://aerpro.com> website and search for your model or scan the QR code below.

aerpro.com/FP9670PK

aerpro.com/FP9670SK

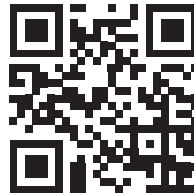

Copyright © 2024 by TDJ Australia

All rights reserved. No part of this publication may be reproduced, distributed, or transmitted in any form or by any means, including photocopying, recording, copying or other electronic or mechanical methods, without the prior written permission of the author.

