

USER/INSTALLATION MANUAL



INSTALL KIT

TO SUIT FALCON

FG

Inclusions

- 1x Double DIN facia kit
- 1x Top dash panel
- 1x Built-in HVAC and steering wheel control unit
- 1x Universal SWC patch lead
- 1x Antenna adapter
- 1x Mounting kit
- 1x MagMate metal plate
- 1x User/Install manual



Product Structure

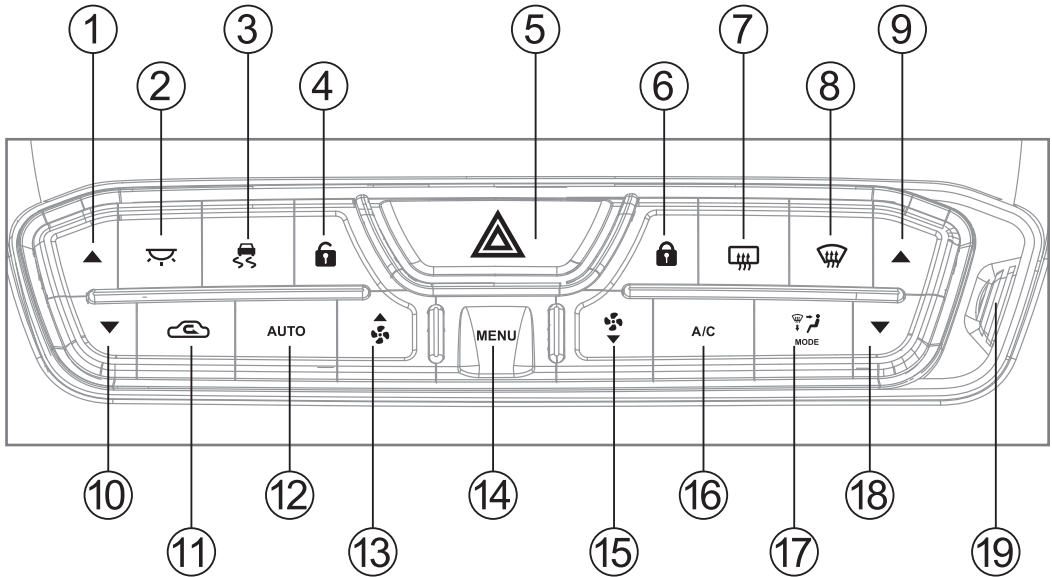

- | | | |
|-------------------------------------|---------------------------------------|-------------------------------------|
| 1. Temperature UP (Passenger side) | 8. Front demister | 14. System menu |
| 2. Interior light ON/OFF | 9. Temperature UP (Drivers side) | 15. Fan speed DOWN/ Menu Navigation |
| 3. Dynamic stability control ON/OFF | 10. Temperature DOWN (Passenger side) | 16. Air conditioner ON/OFF |
| 4. Auto door unlock | 11. Air circulation | 17. Mode |
| 5. Hazard button | 12. Auto climate control | 18. Temperature DOWN (Drivers side) |
| 6. Auto door unlock | 13. Fan speed UP/ Menu Navigation | 19. Temperature Sensor |
| 7. Rear demister | | |

NOTE: The Infodapter video output is NTSC, make sure the headunit and reverse camera is set to NTSC.

Interface Functions

Front Demister

Fresh air is blown through the heater core and then ducted to and distributed over the interior surface of the vehicles windshield

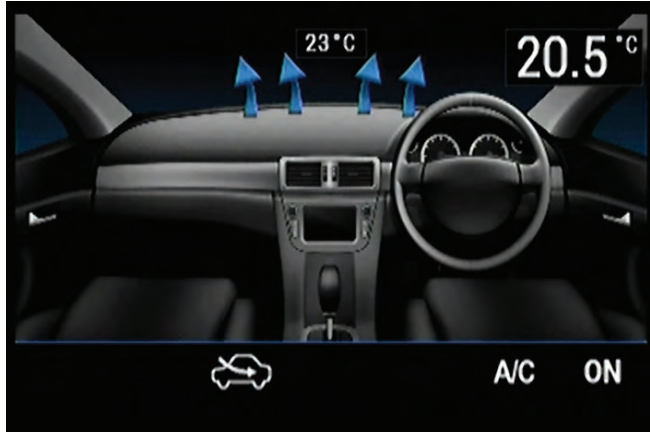
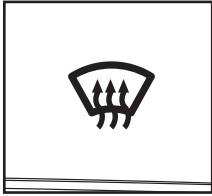

Rear Demister

The demister clears condensation from the rear window

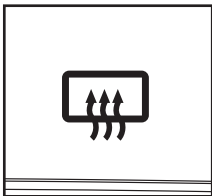

Interface Functions

Air Circulation Mode

Changes between fresh air drawn in directly from the outside of the vehicle, or recirculation where the air is drawn from inside the cabin

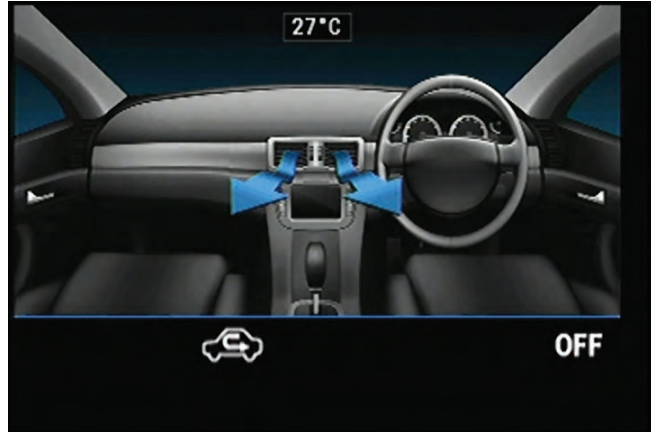
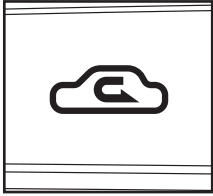

Interface Functions

Mode

Changes the vent positions for heating and cooling

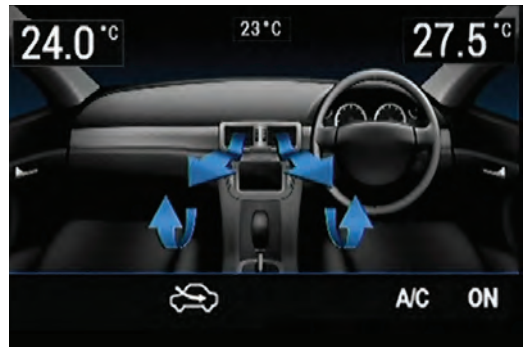
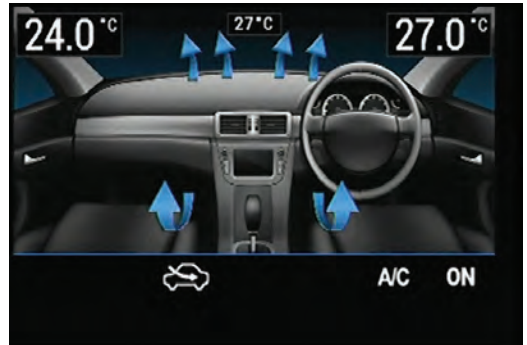
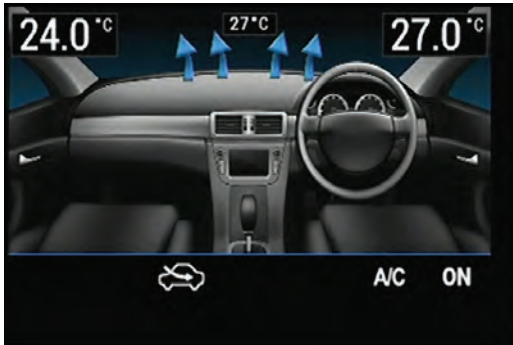
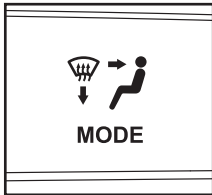

Interface Functions

Heating & Cooling Temperature

Press up to increase temperature, press down to decrease temperature. Left hand side buttons adjust passenger side temperature settings (Front & Rear icon on top LHS). Right hand side buttons adjust drivers side temperature settings (Front & Rear icon on top RHS). External temperature icon is in the top middle

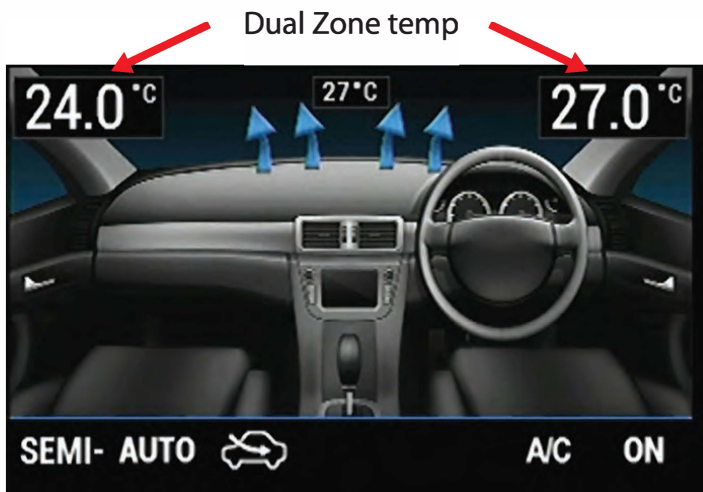
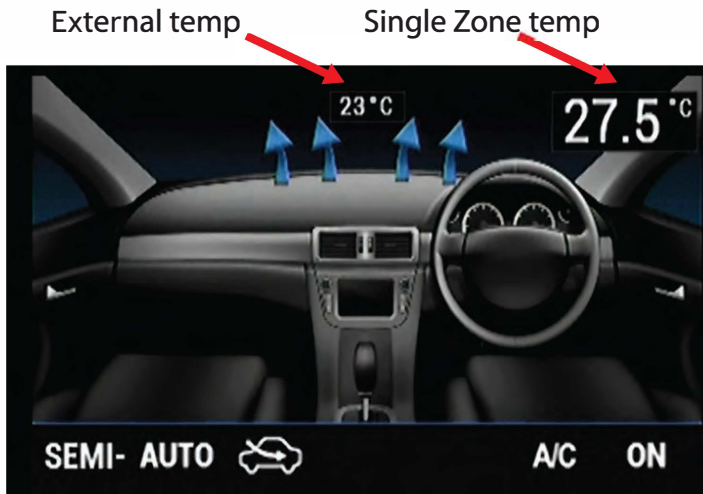
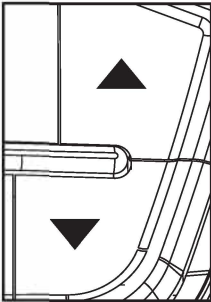

Interface Functions

Air conditioning On or Off

Press to turn the air conditioning On/Off or vice versa. This can be changed and reversed in the setup menu. *Note: Holding down the A/C button completely turns the A/C heating and cooling system Off, which only works for models that had a dedicated OFF AC button prior to upgrade*

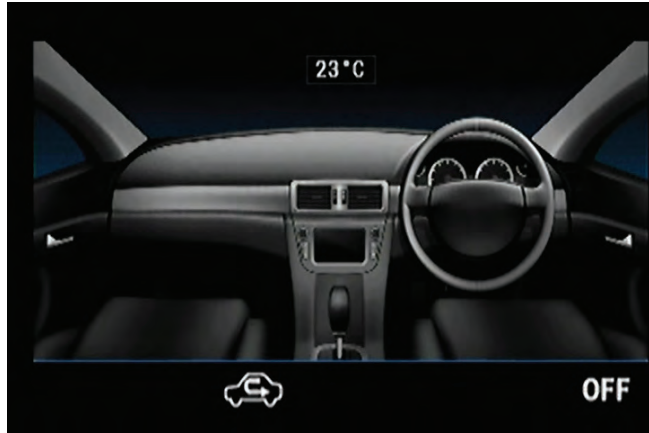
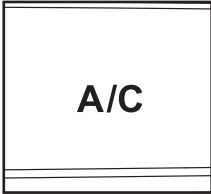

Fan Speed Adjustment

Pressing these will turn the fan speed up and down. **Note:** with the A/C on and fan speed set to zero, there still will be a small amount of cold air pushed out through the vents

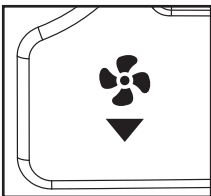
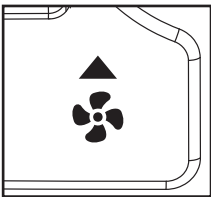

Interface Functions

Auto Function

Press to automatically set the climate control to maintain a specified temperature. Press again to turn off the Auto climate off

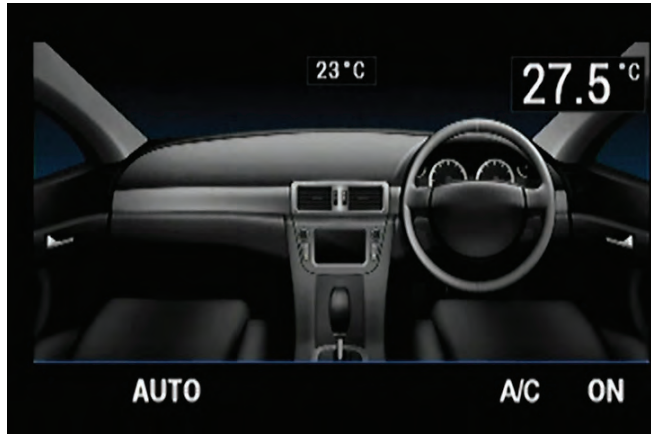
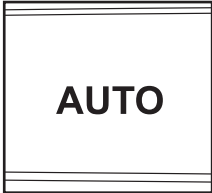

Auto Function (Semi Auto)

Press to manually control the climate control to a desired temperature. Press again to turn the climate control off



Interface Functions

Auto Door Unlock/Lock

Press to lock and unlock all doors in the vehicle

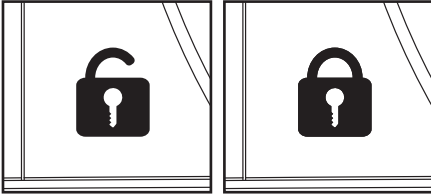

Dynamic Stability Control

Press to turn Dynamic Stability Control (vehicles traction control) on or off

Note: Only works on supported models prior to upgrade



Interior Light

Press to turn the vehicles factory interior light on or off

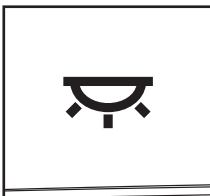

Hazard Flasher Warning Light

Press to turn the vehicles hazard emergency light on or off



Menu Functions

Configuration Menu

Press and hold the menu button for a few seconds to display the Configuration Menu. Press menu button to enter into sub menus and again to change settings. Press the Fan UP/DOWN buttons to navigate up and down between sub menus

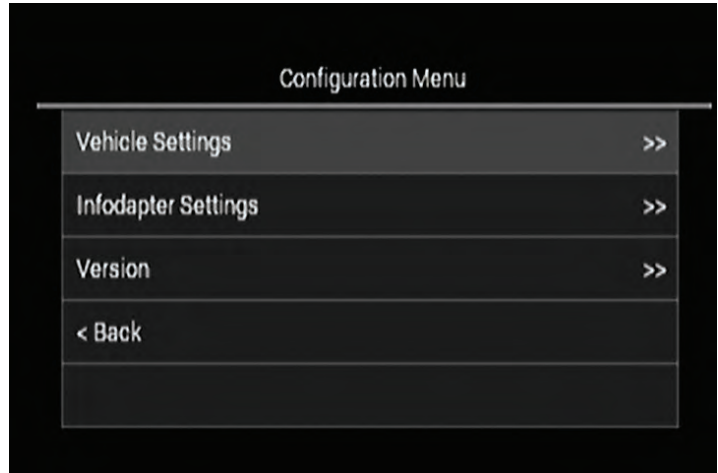
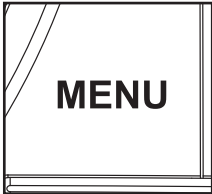

Menu Functions (Infodapter Settings)

Select Infodapter Settings/Preferences to access (5 menus)

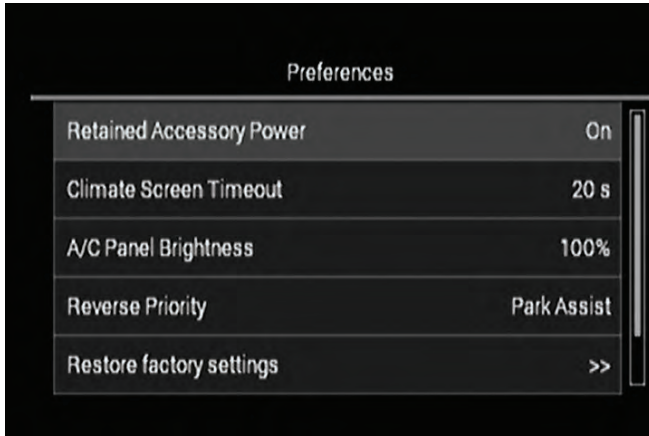

Retained Accessory Power

Controls what the headunit does after the vehicle is turned off. When Off is selected the headunit will turn off when the key is taken out of the ignition. When ON is selected the headunit will turn off when the key is taken out of the ignition and the drivers door is opened

Climate Screen Timeout

Adjust the time it takes the Infodapter screen to return to the Headunit Screen

A/C Panel Brightness

Adjust the brightness of the LED's on the Infodapter

Reverse Priority

Allows the selection of either the camera video feed or the park sensor image when the vehicle is in reverse. (Only appears in menu if camera connection is turned ON)

Restore Factory Settings

Restore all factory settings to default

Menu Functions (Infodapter Settings)

Installer Menu

When in the configuration menu, press and hold the fan UP/DOWN buttons at the same time to access the installer menu

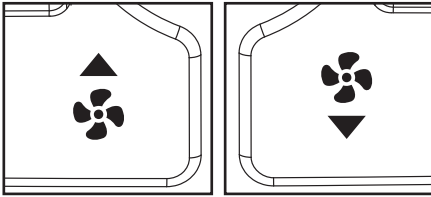

Air Conditioner Type

Choose between a single or dual climate system. *Note: Dual climate systems can run as a single zone system*

Menu Functions (Infodapter Settings)

Screen Size/ Position

Allows the user to change the Infodapter screen to fit to your headunits display

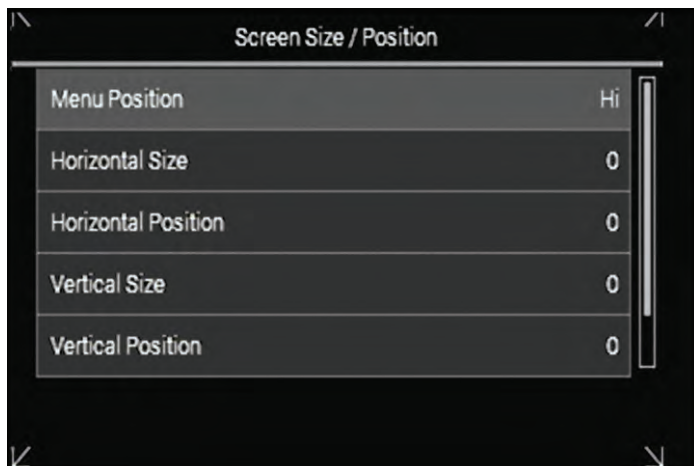

Camera Connected

Turns the reverse camera function On or Off if an aftermarket or factory reverse camera is fitted

Diagnostics

Information on the system to check the vehicle is communicating with the Infodapter

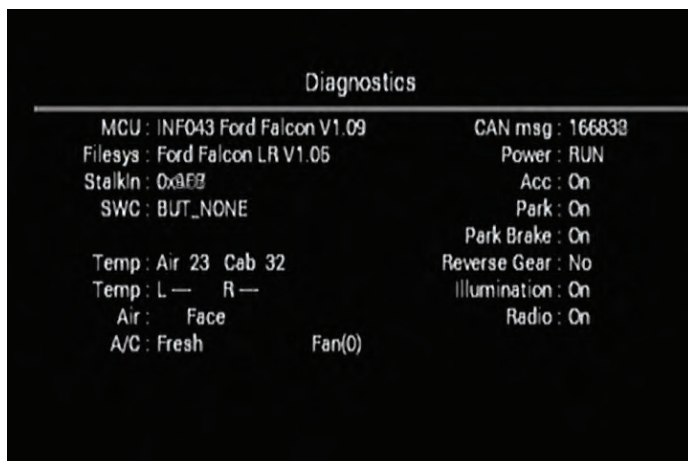

Menu Functions (Vehicle Settings)

In Configuration Menu, select Vehicle Settings to access (3 menus)

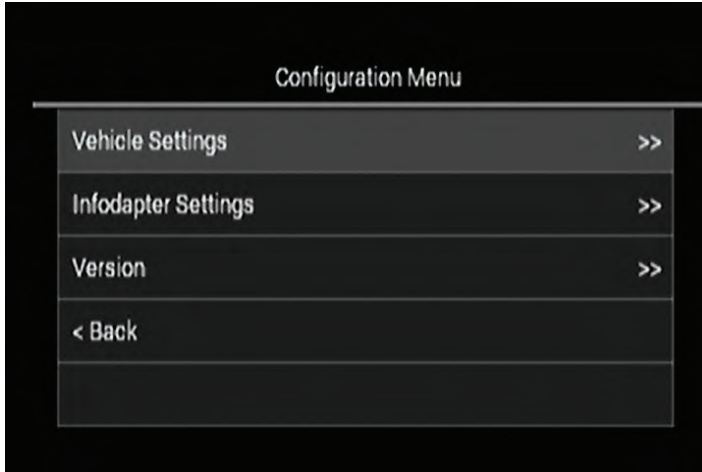

Locking

Drive Away Locking

When Ignition is on, drive away locking will lock all doors when the vehicle speed exceeds 12 km/h and the driver or passenger door is unlocked. This can be manually overridden at any time using the door locks or the central unlock but will reactivate when the vehicle speed exceeds 12 km/h again

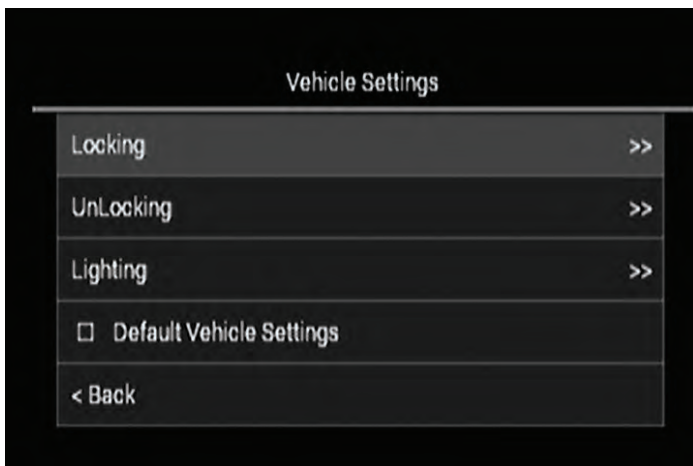

Menu Functions (Vehicle Settings)

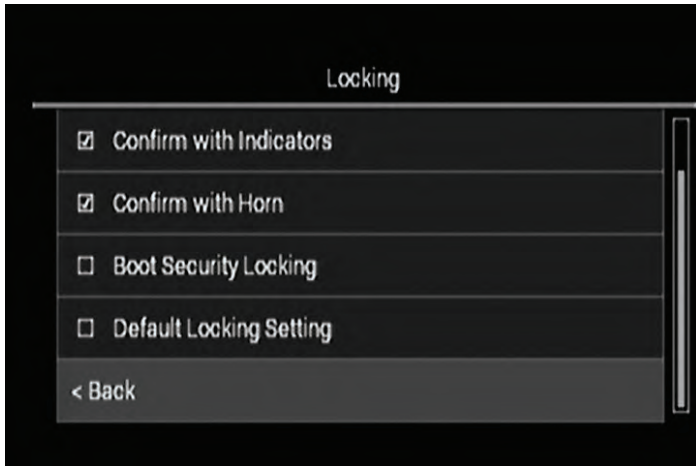

Confirm with Indicators

Lock Confirm with Indicators will flash the indicators twice when the vehicle is locked using the remote key

Confirm with Horn

Lock Confirm with Horn will sound the horn when the vehicle is locked using the remote key

Boot Security Locking

When enabled, the boot release button is active only when the ignition is in the ON position and vehicle speed is below 12 km/h, and also if the vehicle is left unlocked after ignition off

Default Locking Settings

Can only be selected if options are changed from original

Menu Functions (Vehicle Settings)

Unlocking

Each remote key can be individually personalised to function with 2 stage unlock or single stage unlock. 2 stage unlock allows the user to unlock the vehicle in two steps. Unselecting this feature will revert to single stage unlock

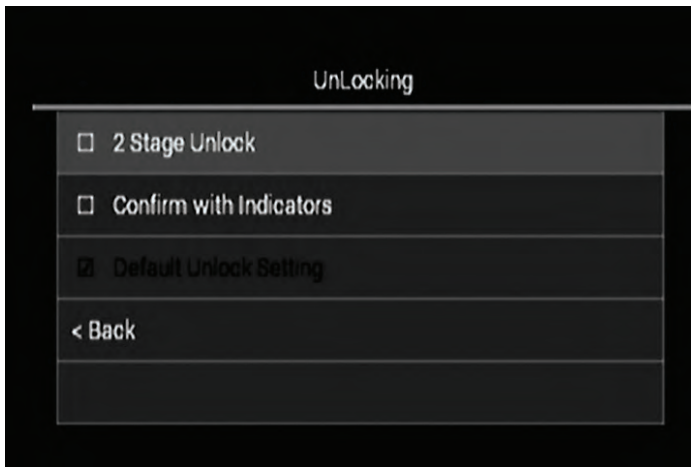

2 Stage Unlock

Press the unlock button on the remote key to unlock the drivers door.
Press the unlock button a second time to unlock all other doors and enable boot release

Confirm with Indicators

Unlock confirm with indicators will flash the indicators once when the vehicle is unlocked using the remote key

Default Unlock Settings

Can only be selected if options are changed from original

Menu Functions (Vehicle Settings)

Lighting

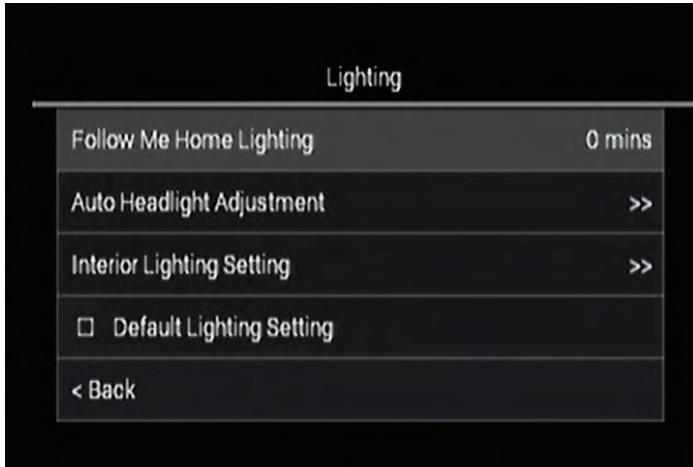

Follow Me Home Lighting

When the headlights are in the auto position, follow me home lighting allows a delay to occur when the key is removed from the ignition before the headlights turn off. Opening the driver door will re initiate this delay. Locking the vehicle via remote key will turn headlights off

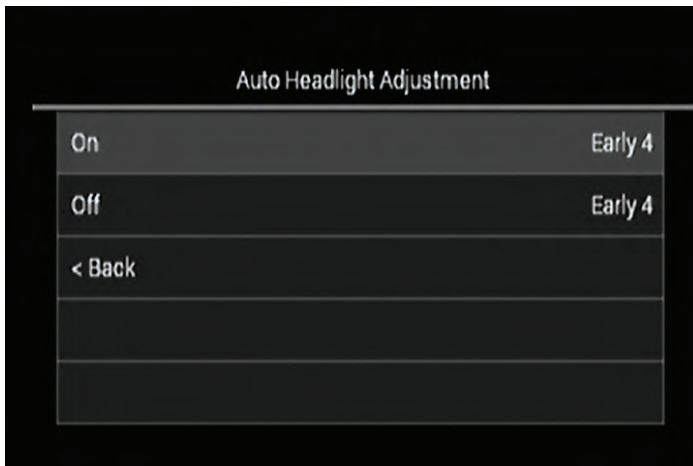

Auto Headlight Adjustments

This adjusts the time delay before the headlights are turned on or off in various lighting conditions

Menu Functions (Vehicle Settings)

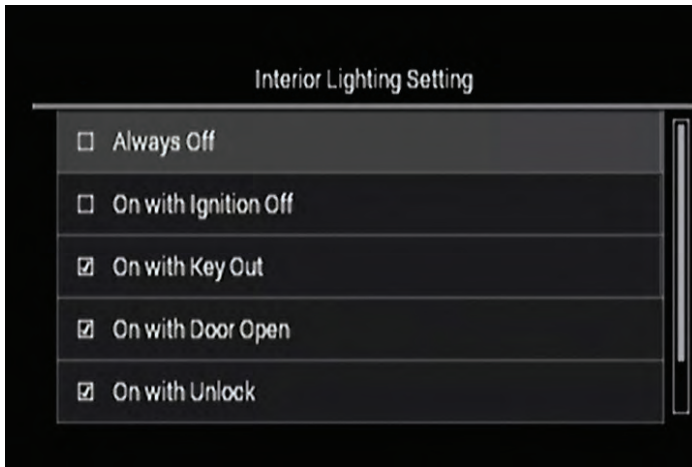

Interior Lighting Setting

Always Off

Always Off ensure the interior dome lamp can never be event activated

On with Ignition Off

On with ignition off allows the dome lamp to turn on when the key is in the ignition off position

On with Key Out

On with key out allows the dome lamp to turn on when the key is removed from the ignition barrel

On with Door Open

On with Door open allows the dome lamp to turn on when any door is open or the boot is released

On with Unlock

On with Unlock allows the dome lamp to turn on when the vehicle is unlocked using the remote key

Default Vehicle Settings

Can only be selected if options are changed from original

INSTALLATION



Tools Needed

Use the following tools to make dismantling the car and the installation of the new facia easier

1. Panel Remover



2. Phillips Head Screwdriver

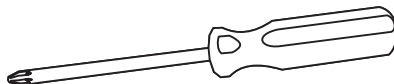

3. 8 mm Ratchet

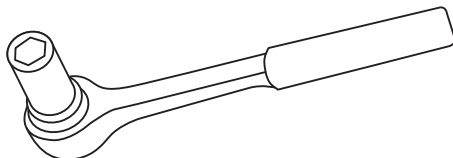

4. Side Cutters

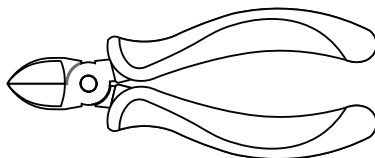

5. Small Pick



6. Cable Ties

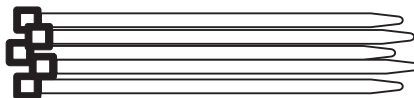

7. Electrical Tape

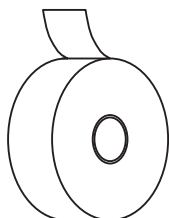

Centre Console Disassembly

Removing pocket (Auto)

Eject any compact disks still in the factory unit. Shift the gear stick down to the “D” drive position.



Firmly pull the storage compartment pocket outwards towards you. Take the pocket out and put it aside.



Headunit Removal

Removing retaining bolts

Using an 8mm socket driver or ratchet, remove the 2 short bolts at the back and the two long bolts on the sides to loosen the factory unit at the bottom.



Headunit Removal

Unplugging the antenna

Push the retaining clip to free the antenna connector from the base of the factory unit.



Removing top panel trim

Using a flat pry tool, carefully lever the top panel up at the side and remove.



Headunit Disassembly

Removing fascia

Remove the two philips head screws at the top and unplug the OEM monitor connector at the top.



Holding the factory unit at the top and bottom, pull the unit back towards you to remove.



OEM Headunit Disassembly

Removing factory headunit face plate

Place the unit on a soft surface and remove the 8 screws holding the side brackets on. (4 on the left and 4 on the right)

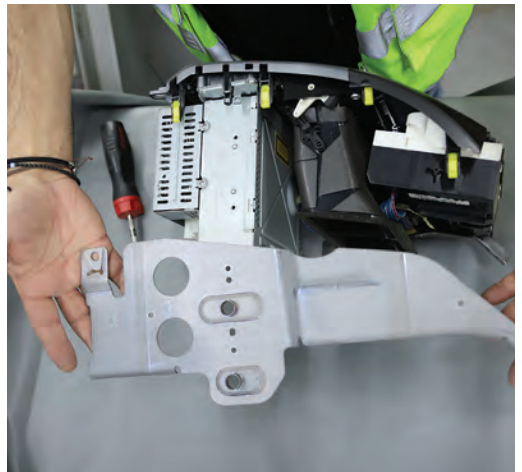
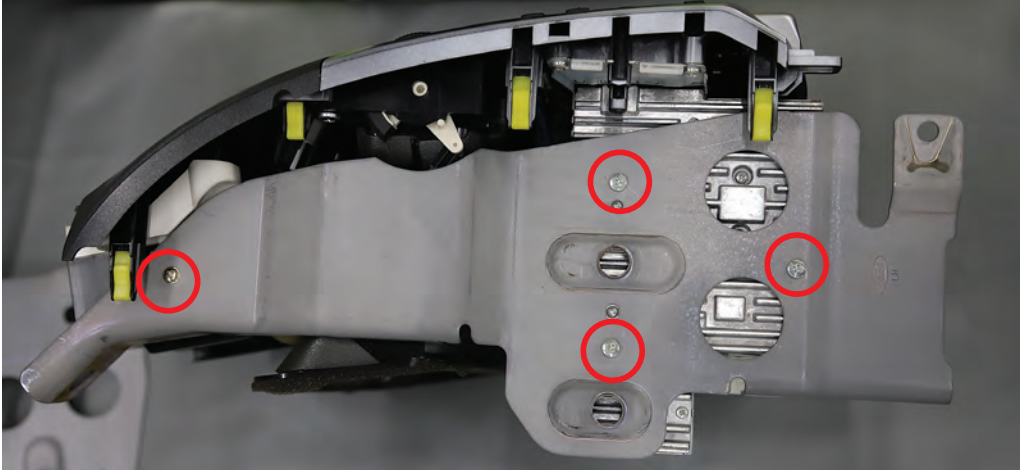

OEM Headunit Removal

Undo the 3 screws holding the factory vent in place. Put aside screws to be reused.

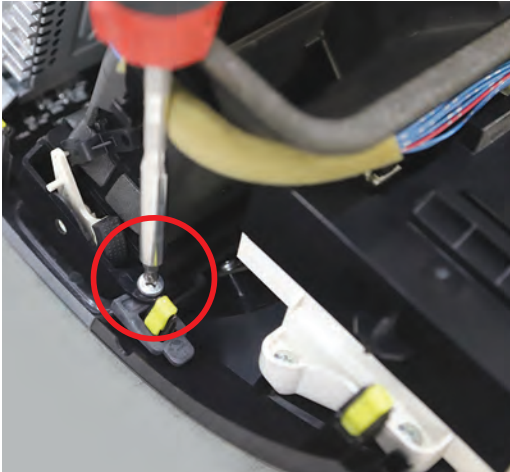

OEM Headunit Disassembly

Remove the cable from the retaining clip on the side of the vent. Remove the vent and put aside.

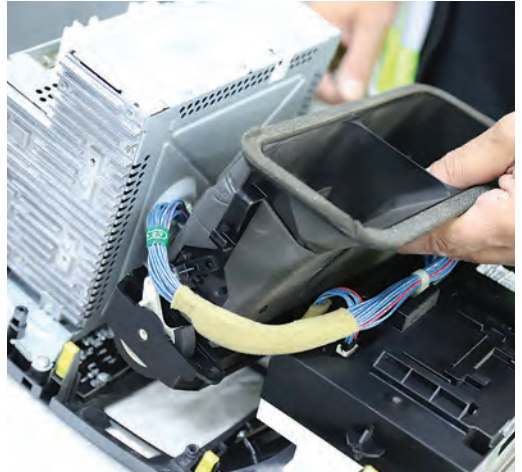

OEM Headunit Disassembly

The new facia comes with pre installed mounting clips. The factory facia mounting clips can also be retained and reused if needed. The top section will need to be separated from the body of the unit to get to two of the yellow clips. Push down on the clip to separate.

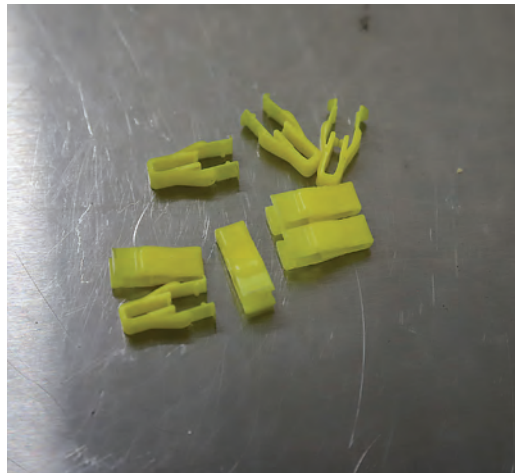
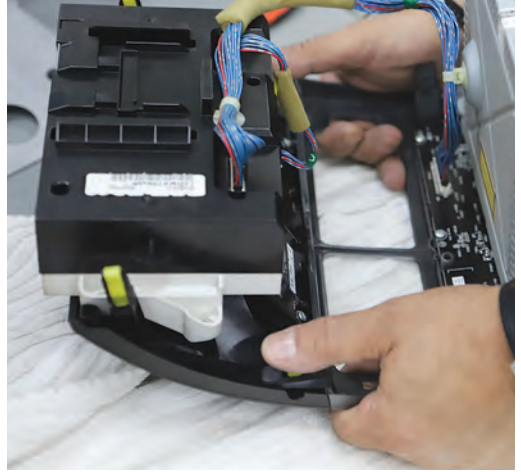
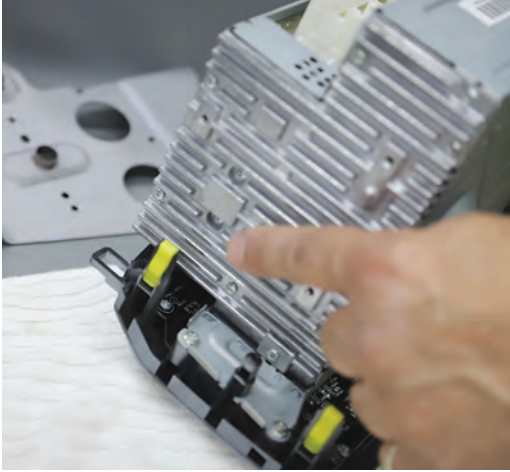

Changing The Dip Switch

DIP switches can be changed to match the headunit and rear camera being used with this installation kit. Make these changes before installing the kit. Check the rear camera and steering wheel control requirements for your devices.

Step1. Access the DIP switches via the cutout on the back of the Infodapter

Step2. Using a pick tool, flick the switches to the required setting

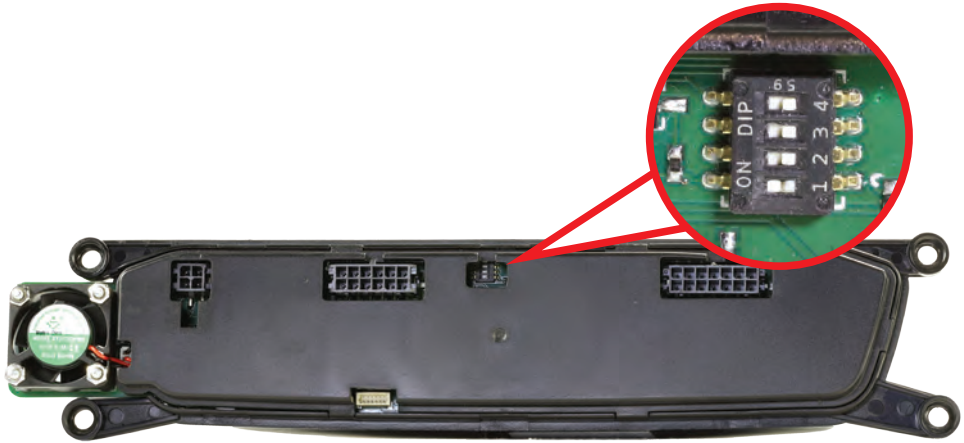

Dip Switch Settings

Up = On, Down = Off

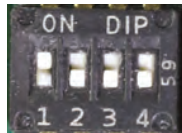

- 1: Pioneer & Sony code change. Dip 1 is ON for Pioneer models, Dip 1 is OFF for Sony models. Check your headunits menu first to make sure the steering wheel controls are activated. Refer to page 2-19 of this manual for more information. Default is ON for most other models.
- 2: Setting for reverse camera. ON = PAL, OFF = NTSC. The default setting is OFF (NTSC).
- 3: Resets the display settings back to default. If the display settings have been manipulated in a way that it is no longer possible to make adjustments, change the DIP switch #3 from OFF to ON and back. This will reset the screen settings to the factory defaults. During this procedure the screen background will change to red. While the background is red, no settings can be made.
- 4: Not applicable

Vent Assembly

Reattaching the vents

Place the new kit, face down on a soft surface. Place the factory vent into position and secure using the 3 screws retained earlier.



Headunit Assembly

Installing your headunit

Place the headunit into the mounting bracket and loosely attach with screws on either side.



Adjust the headunit to the desired depth before tightening the mounting screws on both sides.

Headunit Assembly

Connect the main harness to the control unit. The wires can be routed up through the cable management clip on the vent.

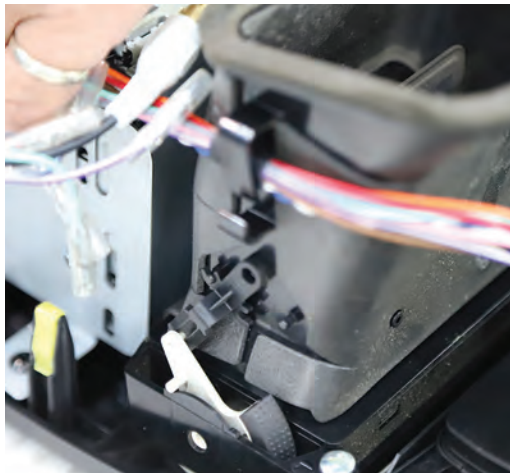

Connect the 4 pin video plug, and connect the yellow RCA plug to the reversing camera input on the aftermarket head unit. Connect the purple reverse output wire to headunit reverse trigger. This will allow the climate controls to display on the aftermarket head unit. The reversing camera wiring must be completed between the fascia and the aftermarket radio, even if a reversing camera is not to be installed, otherwise the vehicle's display will not show on the aftermarket screen. The female yellow RCA socket connects to the reverse camera.

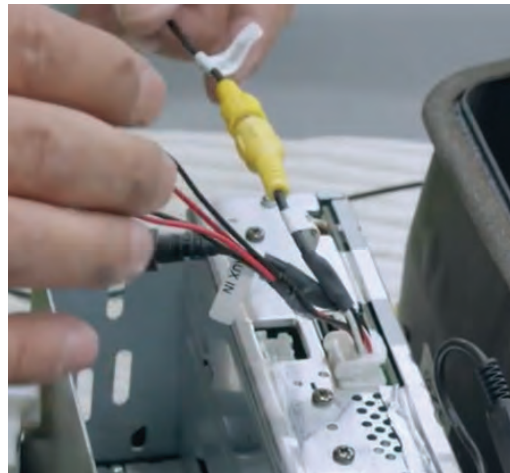

Headunit Assembly

If retaining the factory camera, the APVFD02 retention harness is required (Sold separately). The camera will need to be enabled in the info menu. Connect the SWC patch lead, making sure it is in the correct configuration for your brand of headunit.



Plug the other end of the SWC patch lead into the aftermarket headunit's steering wheel remote input. Connect the brand specific secondary harness (Aerpro App8 series sold separately) into the aftermarket headunit. **NOTE:** *It is important to connect brand specific or correctly modified universal patch lead to module before powering up.*

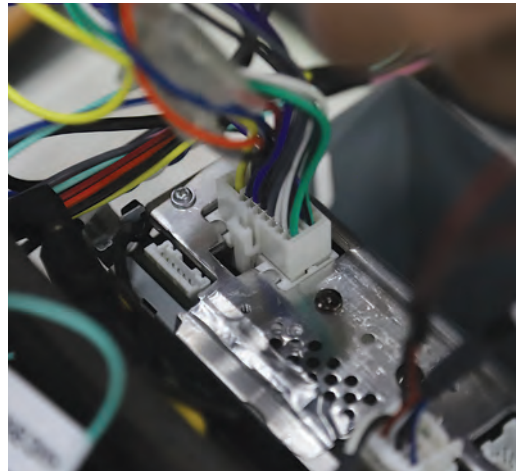

Headunit Assembly

Connect the ISO connectors from the main harness to the secondary harness. Connect any other cables like park brake, reverse and speed pulse if available. Tape up any unused cables. Tape up the now obsolete plug at the top so it does not rattle around and fit the new top panel (supplied) into place.

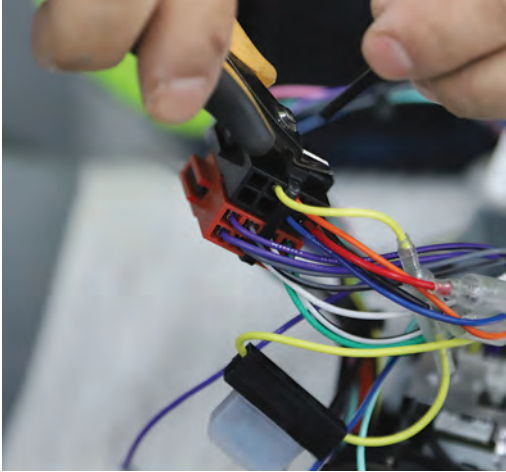

OEM Reverse Sensor (Vehicle Option)

Retaining the OEM reverse sensor alerts

Attach the reverse sensor connector to the Aerpro CHFO1B audio module (sold separately). Securely mount in an appropriate position.

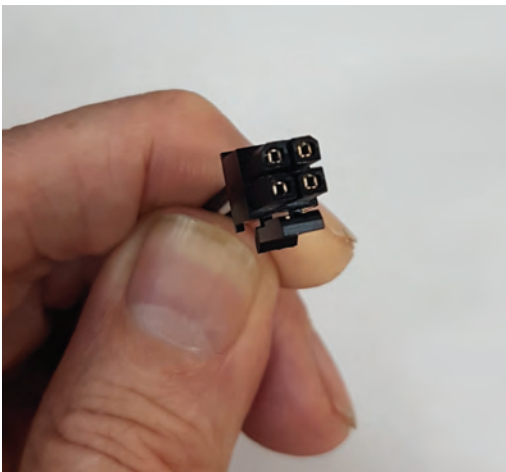

Headunit Assembly

Plug the main harness and antenna adapter into the vehicle.

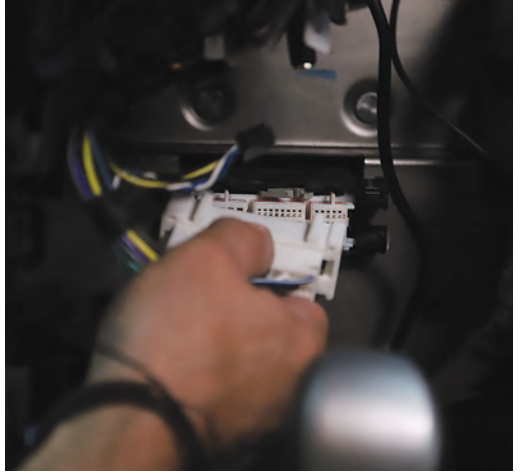
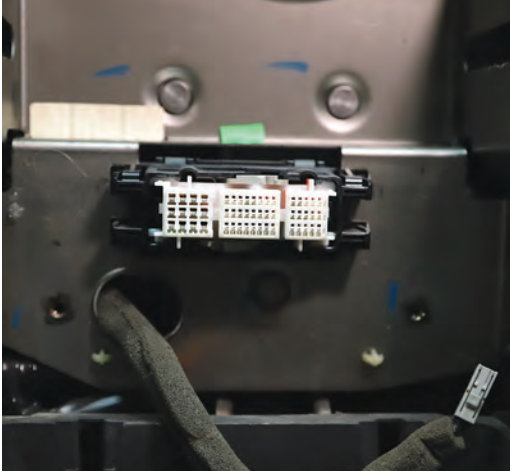

Place the entire unit into the vehicle resting it at the top. Make sure all the cables are out of the way. Push the unit into place.



Headunit Assembly

Switch the vehicle to accessories and turn the parking lights on to test the steering wheel controls, audio and illumination of the HVAC buttons.



Once all of the functions have been tested, replace the tissue pocket.



Wiring diagram

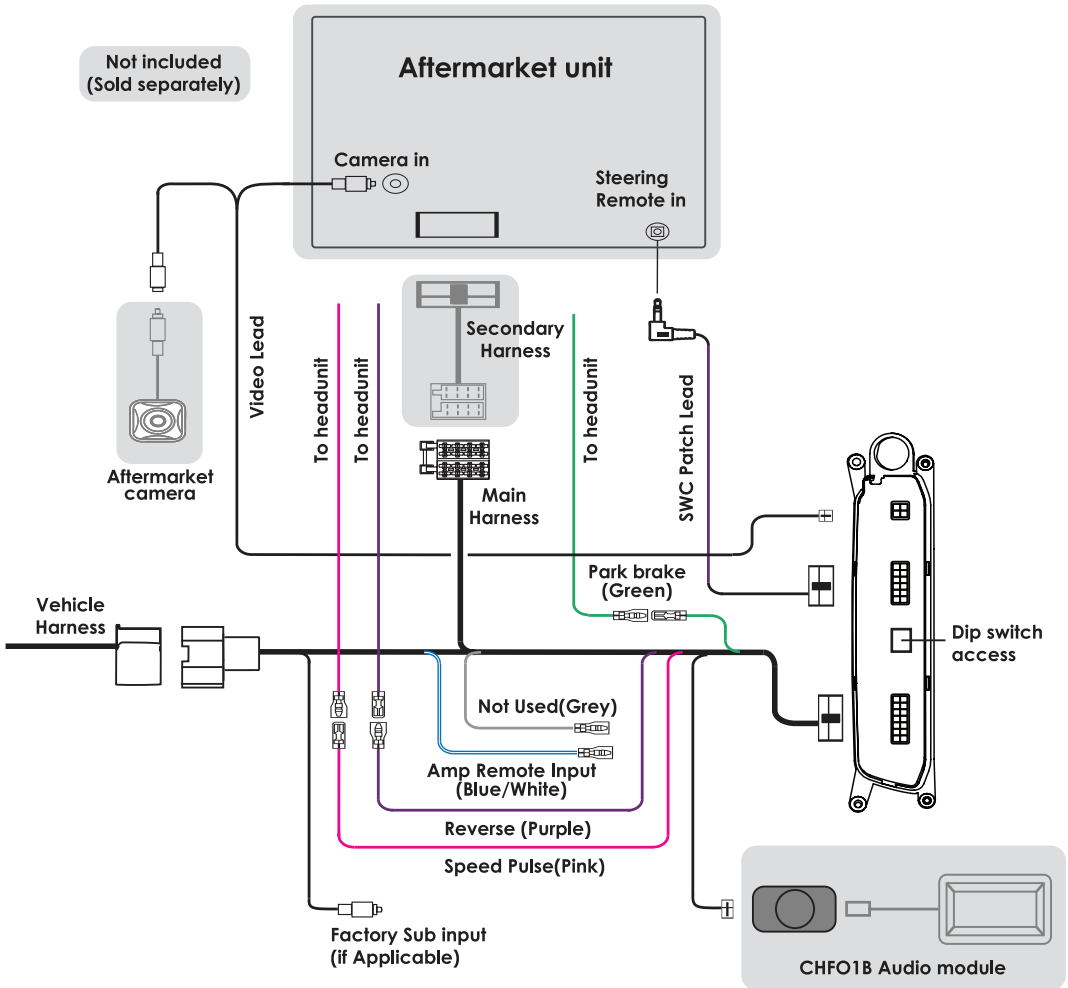

SWC Patch Harness Configuration

Use 3.5mm Jack for these Head-units

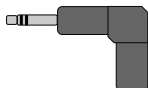

ALPINE

Cut Green Link

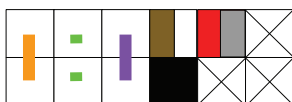

CLARION

Cut Purple Link

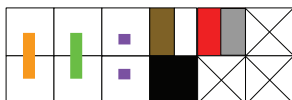

PIONEER

No cutting required

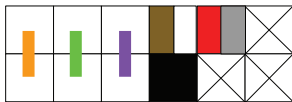

SONY

No cutting required

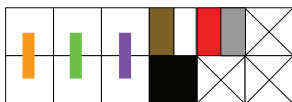

Use Key 1 Bullet terminal for these Head-units



Philips, Nakamichi

Cut Orange & Purple Wire

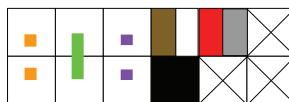

Kenwood

Cut Orange & Green Wire

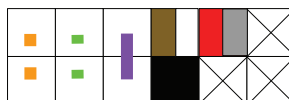

JVC

Cut Green & Purple Link

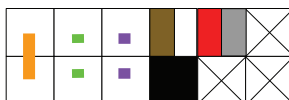

Zenec

Cut all 3 wires, solder Orange and Green together as shown

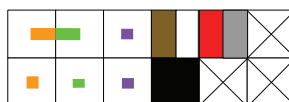

Use KEY 1, KEY 2 and GND Bullet terminals for Self Learn Head-units

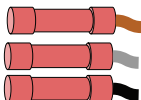

Self Learn

Head-units
No cutting required

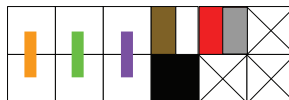

For best results or to reset the control module with a new brand, please make modifications to the patch lead first, before connecting to the steering wheel control module and before powering the module up.

SWC Patch Harness Configuration

Kenwood/JVC: Some Kenwood and JVC radios have 2 steering control inputs. A 3.5mm socket (Remote IN) and Blue with Yellow trace wire. To send direct translated codes to your Kenwood/JVC radio, configure the patch lead up as Kenwood or JVC outlined in the configuration assignments and connect the Brown patch lead wire (KEY 1) used. If you would like to be able to program your steering controls configure the patch lead as Self Learn and plug the 3.5mm Jack into the Remote IN of the Kenwood/JVC, disregard the Brown wire.

Pioneer : Some Pioneer models require the steering controls to be enabled they will by default OFF. These steering control settings are located in the system settings of the radio can only be accessed whilst the unit is in standby mode and the park-brake wire is connected (if applicable). Please refer to your Pioneer manual on exact methods for enabling steering controls.

Sony: Recent Sony models may give you incorrect SWC button results after installing a control harness. This is due to a slight change in input codes on the newer Sony radios. To resolve this please do the following steps:

- Remove the steering control harness from the vehicle.
- Remove the plastic casing from the black steering control box.
- Locate the very small dip switch selector on the board
- Turn dip switch 4 OFF.
- Re-assemble and test.

There is also some Sony radio's that default steering controls off. If you are receiving no steering control functions at all please refer to your Sony manual on how to enable steering controls.

General: Please ensure all connections to your aftermarket head unit (including patch lead modification) are completed before power is provided to the harness. Some of our control harnesses work by translating the vehicles CANBUS data and can only start this process on ignition. If you find that you are not getting any response from your steering controls on accessory (single key click) please re-test on ignition.

Note: The steering controls must be working in the vehicle previously to work with our control harnesses. They will not fix a previous underlying problems.

Technical assistance

If you need assistance setting up or using your Aerpro product now or in the future, call Aerpro Support. Australia

TEL: 03 – 8587 8888



FAX: 03 – 8587 8866

Mon-Fri 9am – 5pm AEST

Please retain this user guide for future reference.

This manual is considered correct at time of printing but is subject to change. For latest manuals, updates and video installation guide refer to the website.

If you would like to find more information on this product or download an up to date digital copy of this manual, please visit the <https://aerpro.com> website and search for your model or scan the QR code below.

<https://aerpro.com/FP9650SK>

<https://aerpro.com/FP9550PK>



Copyright © 2022 by TDJ Australia

All rights reserved. No part of this publication may be reproduced, distributed, or transmitted in any form or by any means, including photocopying, recording, copying or other electronic or mechanical methods, without the prior written permission of the author.

Installer Notes

Installer Notes

