



NA5501
CD/VCD/DVD/MP3/USB PLAYER
GPS/BLUETOOTH
WITH FM/AM TUNER
User Manual



Enjoy the Lifestyle of In-Car Entertainment

Safety Precautions

Thank you for purchasing this product. Please read through these operating instructions so you will know how to operate your model properly. Please keep this manual in a safe place for future reference.

Only connect the unit to a 12-volt power supply with negative grounding.

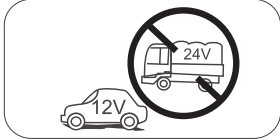

Never install this unit where operating it may impair safe driving conditions.



Never use the front video display function when driving, so as to prevent violating traffic regulations or causing an accident.



Never expose this unit, amplifier, and speakers to moisture or water to prevent electric sparks or fire.

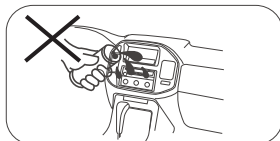

Do not change the fuse on the power cord without professional guidance. Using an improper fuse may cause damage to this unit or even cause fire.



Please contact your nearest dealer if one of the following is experienced:

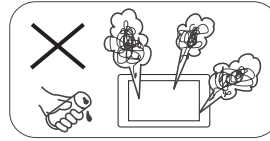

- Water or other objects enter the unit.
- There is smoke.
- Peculiar smell.

To ensure safe driving, please adjust the volume to a safe and comfortable level in case of emergency situations.

Caution

This product is a CLASS 1 LASER PRODUCT. Use of controls or adjustments or performance of procedures other than those specified herein may result in hazardous radiation exposure. Do not open covers and do not repair yourself. Refer servicing to qualified personnel.

Caution of Disc Using

1. Never insert a 3-inch (8cm) CD contained in the adapter or an irregularly shaped CD. The unit may not be able to eject it, resulting in a malfunction.

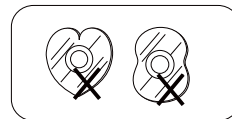

2. Disc Cleaning. Use a dry, soft cloth to wipe the disc from center to edge, only neutral detergent can be used.

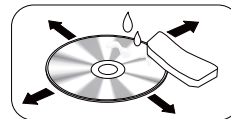

3. When playing a new disc. New disc may have some rough spots around the inner and outer edges. If such a disc is used, remove these rough spots with a pencil or ball-point pen, etc.

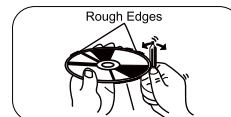

Safety Precautions

1. Never disassemble or adjust the unit without professional guidance.
For details, please consult an authorised service provider or dealer.
2. If the front panel or TFT monitor is dirty, please use a clean silicone cloth and neutral detergent to clean. Using a rough cloth and non-neutral detergent such as alcohol for cleaning may scratch or discolour the monitor.
3. If the unit does not function normally, please refer to the troubleshooting guide of this manual. If no relevant information is found, please press the [RESET] button on the front panel to resume factory default.
4. If you have parked the car in hot or cold weather for a long time, please wait until the temperature in the car becomes normal before operating the unit.
5. Using the car heater in a low temperature environment may result in moisture collecting inside the unit, DO NOT use the unit in this situation. Eject the disc and wipe off the moisture on the disc. If the unit does not work after a few hours, please contact the service center.
6. Do not drop or bang the LCD monitor as this will damage it.
7. To prevent damage to the screen, avoid touching it with sharp objects.
8. Graphic illustrations are used to provide a clear demonstration and an easy way to understand how to operate this unit.
However, some illustrations are different from the actual images displayed on the screen.
9. Only operate the unit as described in this manual. Inappropriate operation will void the guarantee.

Expanding Systems

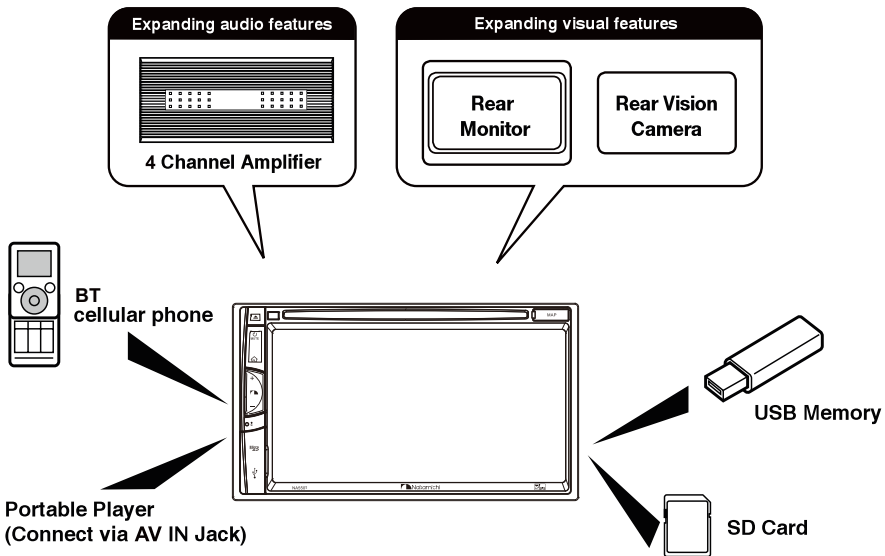

 **Note:** The items listed outside of the frame are the commercial products generally sold.

Contents

Safety Precautions	1	Select Subtitle Language.....	15
Before Using	4	Change Viewing Angle	15
Front Panel	4	Video Setup	15
Remote Control.....	5	Playback Information	15
Notes on Remote Control Usage.....	6	Direct Track Entry	16
Uninstall Battery.....	6	Rotate Pictures	16
Install Battery	6	Zoom.....	16
Basic Operations	7	Bluetooth Mode	17
Parking Brake Inhibit.....	7	Pair the Bluetooth-enabled Devices	17
Mute.....	7	Disconnect Bluetooth Device.....	17
OSD language Selection	7	Make a Call.....	17
Power On / Off.....	7	Answer an Incoming Call.....	17
Audible Beep Confirmation.....	7	Adjust Bluetooth Settings.....	18
Playing Source Selection.....	7	Music Mode A2DP	18
Volume Adjustment.....	7	AVRCP	18
EQ Menu.....	7	Settings	19
Select Preset Equalizer	8	Display System	19
Adjust EQ Parameters	8	Adjust General Settings.....	19
Adjust Fader/Balance	8	Calibration.....	19
Set Date /Time.....	9	Adjust Video Settings.....	19
Radio Mode	10	Adjust Sound Settings	20
Tuner TFT Display	10	Adjust Time Settings.....	20
Select Radio as Playing Source	10	Adjust Language Settings.....	20
Select One Radio Band	10	Adjust Bluetooth Settings.....	20
Tune.....	10	Adjust DVD Rating.....	20
Preset Station	11	Adjust Volume Settings.....	21
Local Seeking	11	Other Modes	22
EQ Selection.....	11	Listen to Other Devices	22
RDS Basics.....	11	Reset	22
Adjust RDS Settings	11	Replace a Fuse.....	22
RDS (Radio Data System).....	11	GPS	22
AF Function	12	Steering Wheel Control Programming	22
EON Function	12	TV(Ready)	22
TA Function	12	Specifications	23
CT Function	12	Troubleshooting	25
PTY Function.....	12	Installation	26
Playback Mode	13	Wire Connections	27
Load a Disc.....	13	Quick Start Guide	28
Eject a Disc.....	13		
Touch Screen Controls	13		
Controlling Playback.....	13		
Connect a USB Device	13		
Remove a USB Device	13		
Insert/Remove a SD Card.....	13		
Play/Pause.....	14		
Previous/Next	14		
Search for a Folder.....	14		
Repeat	14		
Repeat A-B	14		
Shuffle (Random) Play.....	15		
Select Audio Mode.....	15		

Before Using

Front Panel

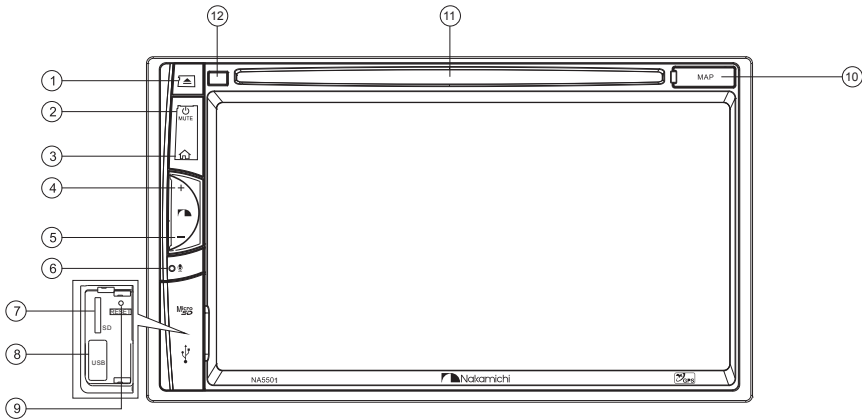

Notice:

The graphic in this manual is for reference only, and may be different from the actual unit. Reference to actual unit is suggested.

1. [EJECT] Button

Press to eject a disc.

2. [POWER] Button

Press to turn the unit ON. Press and hold to turn the unit OFF.

Press momentarily to activate the MUTE function. Press again to resume normal listening.

3. [HOME] Home Button

4. [VOLUME+] Button

Press to increase the volume. Press and hold to increase the volume continuously.

5. [VOLUME-] Button

Press to decrease the volume in steps. Press and hold to decrease the volume continuously.

6. Internal Microphone

Internal microphone for Bluetooth calls.

7. SD Interface Connector

Insert an Micro SD card for playback of music/video files.

8. USB Connector

Connect a USB device for playback of music/video files.

9. Reset Button

10. Map Slot

The Micro SD card is used for the Navigation Map only, not for music or other files. This may be used for firmware updates if required.

11. Disc slot

12. Remote sensor

Press to reset system settings to factory default (except password and parental lock settings).

Before Using

Remote Control

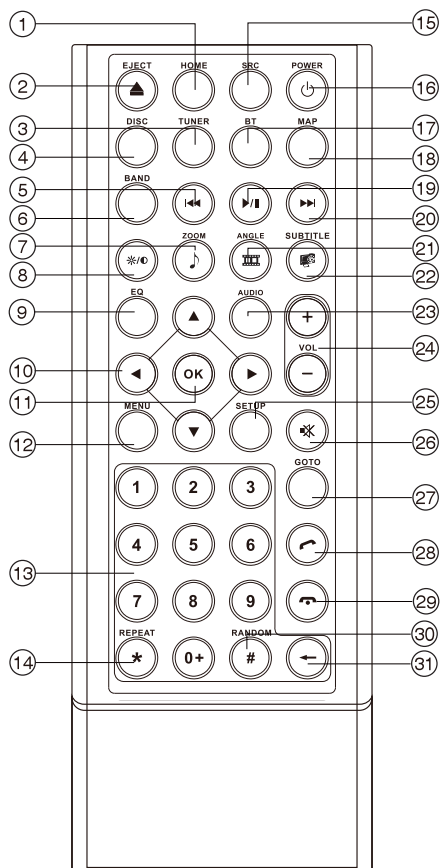

1. Return to the home menu
2. Eject the disc
3. Access to tuner source
4. Access to disc source
5. - Search an available radio station by decreasing tuning frequency
- Select the previous chapter/track for playback
6. Select radio band
7. - Zoom in(Video menu of DVD/VCD)
- Access to music list (Audio menu of music playing)
8. Adjust screen settings
9. Open EQ menu
10. Menu cursor
11. Enter
12. - Open route menu (DVD)
- Turns on/off PBC (VCD)
13. Digit area
14. Repeat playback
15. Change to next source
16. Power on/off
17. Access to Bluetooth source
18. Access to navigation source
19. Pause playback/Start playback
20. - Search an available radio station by increasing tuning frequency
- Select the next chapter/track for playback
21. - Playback disc in different angle for a scene (DVD)
- Rotate (photo playing)
- Access to video list
22. - Language selection for subtitle (DVD)
- Access to photo list
23. Change the audio language for disc playback (DVD)
24. Increase/Decrease volume
25. Access to settings source
26. Mute On/Off Audio Output
27. Activate direct access mode
28. Dial/Receive a call
29. Hang up
30. Play all chapter/tracks in random order
31. - Press to clear the number one by one
- Hold to clear all the numbers

Before Using

Notes on Remote Control Usage

1. Aim the remote control at the remote sensor on the unit.
2. Replace the battery from the remote control or insert a battery insulator if the battery has not been used for a month or longer.
3. DO NOT store the remote control in direct sunlight or in high temperature environment, or it may not function properly.
4. The battery can work for 6 months under normal condition. If the remote control won't work, please change the battery.
5. Use "button shaped" lithium battery "CR2025" (3V) only.
6. DO NOT recharge, disassemble, heat or expose the battery in fire.
7. Insert the battery in proper direction according to the (+) and (-) poles.
8. Store the battery in a place where children cannot reach to avoid the risk of accident.

Uninstall Battery

Slide out the battery compartment tray at the bottom on the back of the remote control.

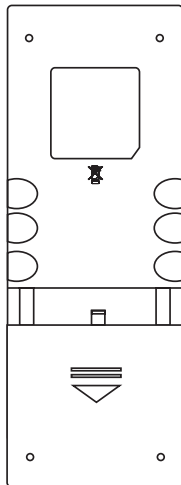

 PULL OUT

Install Battery

Use button-shaped lithium battery "CR2025 (3V)" only. Insert the battery to the battery tray with proper direction according to the (+) and (-) poles.

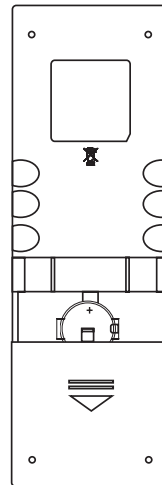



PUSH IN 

Basic Operations

Parking Brake Inhibit

- When the “BRAKE” cable is connected to the brake switch, the display on the TFT monitor will display video only when the vehicle is applied.
- Parking brake function is overridden when the video source is set to REVERSE.
- When the parking brake inhibit is active, the front monitor displays “WARNING Do not watch video while driving!”, preventing the driver from watching content while driving. Rear video screens are not affected.

Mute

Press [] button to mute the volume from the unit. Press again to restore the volume. [] is displayed on the LCD. Adjusting the volume or using any of the audio setup features cancels the mute function.

OSD language Selection

1. The available OSD languages are displayed when power on first time or after reset the unit.





Tap a language.

The OSD language is changed to the selected language immediately.

2. You can also select language in the settings.

Power On / Off

Press the [] button on the unit to turn the unit on.

Press and hold the [] button to power off the unit.

Audible Beep Confirmation

An audible beep tone confirms each function selection. The Beep tone can be disabled through the Setup menu.



Playing Source Selection

Press the [] button on the front panel to change between available playing sources. The playing mode is displayed on the screen.



1. Date and Time display.



2. Function icons

3. [] or []: Touch this page button to view the first or second page of on-screen buttons. You also can drag left or right on the blank area to switch the pages.

4. Touch to Settings function .

5. Touch for quick access to Equalizer level settings.

Volume Adjustment

To increase or decrease the volume level, turn the [] / [] button on the front panel. The volume ranges from “0”to “50”. The LCD or TFT screen displays the volume level for 3 seconds.

EQ Menu

The Audio Control feature allows you to easily adjust your audio system to meet the acoustic characteristics of your vehicle, which vary depending on the type of vehicle and its measurements. Proper setting of the Fader and Balance boosts the effects of the cabin equalizer.

Basic Operations

Select Preset Equalizer

1. Enter the EQ setup mode
Touch the [EQ] icon in the user interface and the EQ setup interface will display on the screen.
2. Select EQ mode
 - [Optimal] · [Classic]
 - [Rock] · [Jazz]
 - [Techno] · [Pop]
3. [RESET]: Cancel the equalizer function settings.



Adjust EQ Parameters

To adjust EQ parameters, touch the parameters adjustment bar.

Touch [+] / [-] to adjust the parameters.

[User]: Set the desired audio effect.

[Flat]: Select the original audio effect.

[Reset]: Cancel the equalizer function settings.

[Loud: On/Off]: When listening to music at low volumes, this feature will selectively boost certain bass and treble frequencies.

Adjust Fader/Balance

You can adjust front/back/left/right balance of the speaker and the subwoofer volume to get larruping listening effect according to the surroundings and your interest.

1. Enter the EQ setup mode
Touch the [EQ] icon in the user interface and the EQ setup interface will display on the screen.

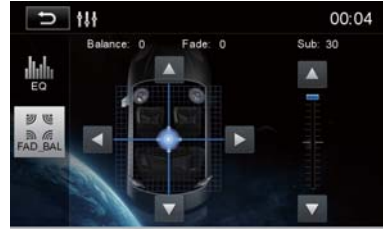

2. Adjust subwoofer volume
Touch [▲] / [▼] or drag [■] to adjust subwoofer volume from 0 to 30.
3. Adjust fader / balance value
Touch [▲] / [▼] / [◀] / [▶] to adjust fader / balance value
 - [▲]: Front speaker, fader range: 0 to 20.
 - [▼]: Rear speaker, fader range: 0 to 20.
 - [◀]: Left speaker, balance range: 0 to 20.
 - [▶]: Right speaker, balance range: 0 to 20.

Note:

1. The parameters of the EQ modes has been preset and you can not change them besides 'User'.
2. The EQ mode will change to 'User' automatically when you adjust the frequency value in all modes besides 'User'.
3. The value of Sub is independent of EQ mode and can be adjusted separately.

Basic Operations

Set Date /Time

1. Touch [].
2. Touch [Time].
The date/time setup menu is displayed.



• Set Date

1. Touch [Date].
2. Touch the date information on the screen .
A submenu is displayed.
3. Touch [▲] or [▼] to set year, month and day.

• Set Clock Mode

1. Touch [Clock Mode].
2. Touch [12H] or [24H] to switch to time mode.

• Set Time

1. Touch [Time].
2. Touch the time on the screen, a submenu is displayed.
3. Touch [▲] or [▼] to set hour and minute.

Radio Mode

Tuner TFT Display

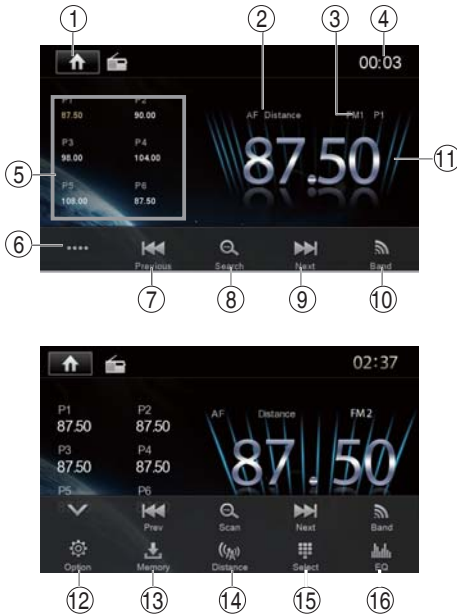

1. Touch to view the SOURCE MENU and select a new playback source
2. Distant signal broadcasting indicator
3. Current radio band indicator
4. Clock
5. Broadcaster information stored at the preset
6. Touch to view more on-screen buttons
7. Touch to seek backward
8. Scan preset stations
9. Touch to seek forward
10. Touch to change between AM/FM bands
11. Current radio information
12. RDS setting options
13. Current band preset radio stations
14. Touch to change between Local and Distance
15. Enter frequency directly
16. Touch for quick access to Equalizer level settings

Select Radio as Playing Source

Open the Source Menu and then touch [Radio].

Select One Radio Band

Press the [BAND] button on remote control or touch the [📶] icon on the user interface to select one radio band from FM1, FM2, FM3, AM1 and AM2.

Tune

Auto Tuning

Press the [⏪] / [⏩] button on the remote control briefly or hold [⏪] / [⏩] icon on the user interface for more than 1 second to seek a higher / lower frequency.

To stop searching, repeat the operation above or press other buttons having radio functions.

Note:

When a station is received, searching stops and the station is played.

Manual Tuning

Method 1:

During manual tuning, the frequency will be changed in steps.

Press the [⏪] / [⏩] button on remote control or touch the [⏪] / [⏩] icon on the user interface to tune in a higher / lower station.

Method 2:

1. Touch the numeric keypad icon [🔢].
Numeric keyboard is displayed, touch number to input frequency.



2. Touch [⏪] to delete the input number step by step.
3. Touch [OK] to enter.

Radio Mode

Preset Station

The unit has 5 bands, such as FM1, FM2, FM3, AM1, AM2, and each band can store 6 stations; hence the unit can store 30 stations in total.

Intro/Scan

Press the [🔍] icon to intro. Each stored station will play for 5 seconds automatically. Hold down the [🔍] icon to scan. Only stations with sufficient signal strength will be detected and stored in the memory. After scanning, P1 will play automatically.

Manual Store

1. Tune to a station.
2. Touch [••••] to display the 2nd menu.
3. Touch [⬇️].
4. Touch one of the channels P1 to P6 to save the selected band.

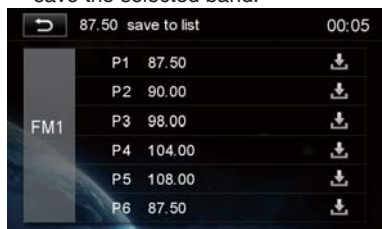

Tune to a Preset Station

1. Touch [Radio].
2. Select a band (if needed).
3. Touch one of the preset channels (P1 to P6) on the screen.

Local Seeking

Touch the [📶] icon and choose the Radio Local or Distance.

When the [📶] icon turns bright, only stations with sufficient signal strength will be detected.

EQ Selection

Press the [📊] icon and enter the EQ setup.

RDS Basics

RDS transmits data to the radio which displays information such as station identification, song artist, and song title. RDS service availability varies with areas. Please understand if RDS service is not available in your area, the following service is not available.



Adjust RDS Settings

1. In Radio menu, touch [⚙️].
The option menu is displayed.
2. Touch on the selected option to change the setting.
 - [RDS]: To turn on or off "RDS" function.
 - [AF]: To turn on or off "AF" function.
 - [EON]: To turn on or off "EON" function.
 - [TA]: To turn on or off "TA" function.
 - [CT]: To turn on or off "CT" function.
 - [PTY]: To show PTY list.

RDS (Radio Data System)

The unit provides basic functions of RDS. RDS service availability varies with areas. Please understand if RDS service is not available in your area, the following service is not available.

Radio Mode

AF Function

Alternative Frequencies Lists are used for the same program service and used in conjunction with the PI code (Program Identification code) to assist automatic tuning. Using this information, a radio can automatically search out another station that is playing the same material. This is useful when the station you are listening to is fading out.



Note:

- During auto switching radio frequency, some interference could be heard.
- Turning off AF function can settle this problem.

EON (Enhanced Other Networks)

When EON data is received, the EON indicator lights and the TA and AF functions are enhanced.

TA: Traffic information can be received from the current station or stations in other network.

AF: The frequency list of preset RDS stations is updated by EON data. EON enables the radio to make full use of RDS information. It constantly updates the AF list of preset stations, including the one that it is currently tuned into. If you preset a station around the area of your home, you will later be able to receive the same station at an alternative frequency, or any other station serving the same program. EON also keeps track of locally available TP stations for quick reception.

TA Function

The TA (Traffic Announcement flag) function lets the unit receive traffic announcements automatically no matter what media source is playing back. The TA function can be activated by a TP (Traffic Program) station broadcasting traffic information.

When TA is activated and a traffic announcement is received, the current playing source will be overridden by the traffic announcement if the current radio band is FM, indicating that the unit is waiting for traffic announcements.

The unit returns to the original source after the traffic announcement has been received.

To activate TA function, touch the [TA] button on the user interface.

To cancel this function, do the operation above again.

CT (Clock Time)

Some stations broadcast the time and date within the encoded RDS signal. The clock time is automatically adjusted when 'CT' is set to 'ON'.

PTY Function

PTY is the abbreviation for Program Type which is a code defining the type of program being broadcast (e.g. News or Rock).

Then PTY options will display on the screen. To view more PTY options, touch the scroll bar and arrows on the screen.

When one PTY option is touched (e.g. News), auto search for next available PTY by increasing tuning frequency until the PTY of the next station matches the current. If no matched PTY has been found, the unit will return to the original radio frequency.

Playback Mode

Load a Disc

You can play video, audio or images stored on the following discs:

- DVD Video, DVD-R, DVD-RW
- VCD
- Audio CD, CD-R, CD-RW

Note:

Ensure that the disc contains playable content.

Eject a Disc

Press the [] button on the front panel or remote control to eject the disc. When the disc is ejected, the unit switches to the previous source.

Touch Screen Controls

The touch key areas for DVD playback are outlined below:

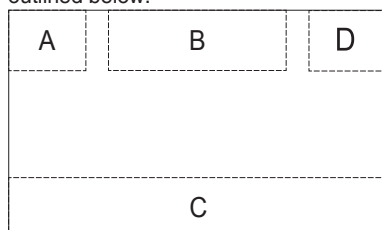

A: Return to the main menu

B: Play the video and display playback information

C: Display onscreen control menu

D: Time display

Controlling Playback

To access the on-screen controls, touch the screen anywhere except for the upper left corner, and touch again to cancel display. Touch [] to view all function icons.



Connect a USB Device

1. Open the USB door.
2. Insert the USB device into the USB slot.
Play starts automatically.

Remove a USB Device

1. Select another source in the main menu.
2. Remove the USB device.

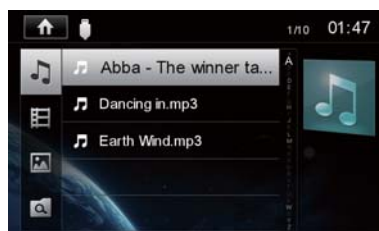

Insert/Remove a SD Card

- Insert
 1. Open SD card cover.
 2. Insert the SD card into the SD card slot, the unit will read the files automatically.
- Remove
 1. Select another source in the main menu.
 2. Press the card unit you hear a click sound.
 3. Remove the SD card.

Note:

1. Not guarantee the unit can compatible with all the USB/SD devices;
2. Front USB can support charging (1A) for partial Android mobile;
3. To use the Rear USB, please come to Main Interface for access .

Playback Mode

Play/Pause

- Once a disc, USB is inserted, play starts automatically.
For DVD movie, if a menu appears, press [▶] to start play.
- To pause, touch [⏸].
To resume play, touch [▶].



Previous/Next

Touch [⏮] / [⏭] icon on the screen to skip to previous / next track / chapter.

Search for a Folder

For Video Files

- Touch [📁] to display all available video folders.
- Touch a folder, then touch the desired file.
- Touch the file again to start play.

For Audio Files

- Touch [🎵] to display all available audio folders.
- Touch a folder, then touch the desired file.
- Touch the file again to start play.

For Picture Files

- Touch [🖼️] to display all available picture folders.
- Touch a folder, then touch the desired file.
- Touch the file again to start play.

Repeat

For DVD/VCD movie disc:

- Touch bottom half of the screen to display menu on the screen, if necessary.
- Touch [••••] to display the 2nd menu.
- Touch [↺] repeatedly to select:
 - DVD
[↺] Repeat chapter: Play the current chapter repeatedly.
[↺] Repeat title: Play all chapters in the title repeatedly.
[↺] Repeat all: Play all in the disc repeatedly.
Repeat off: Cancel repeat play.

- VCD

- [↺] Repeat single: Play the current single repeatedly.
- [↺] Repeat all: Play all in the disc repeatedly.
Repeat off: Cancel repeat play.

For CD/MP3/WMA files:

- Touch anywhere except the upper left corner to display menu on the screen, if necessary.
- Touch [↺] repeatedly:
 - [↺] Repeat single: Play the current single repeatedly.
 - [↺] Repeat all: Play all in the disc repeatedly.
 - [↺] Repeat folder: Play all in the current folder.
 - [↺] Repeat off: Cancel repeat play.

Repeat A-B

You can repeat a specific of video file (repeat A-B).

- Touch the screen to display control menu, if necessary.
- Touch [••••] to display the 2nd menu, if necessary.
- Touch [A-B] repeatedly to mark:
Repeat A-: the start of the section to repeat.
Repeat A-B: the end of the section to repeat.
The selected section plays repeatedly.

Playback Mode

4. To exit A-B repeat mode, touch A-B repeatedly, [Repeat A-B off] is displayed.

Shuffle (Random) Play

You can play audio tracks/files in random order.

1. Touch the screen to display control menu, if necessary.
2. Touch [••••] to display the 2nd menu, if necessary.
3. Touch [⌘] on the screen repeatedly to turn random play on or off.

Select Audio Mode

When you play VCDs, you can select an audio mode (R/L/Stereo).

1. During play, touch bottom half of the screen to display menu on the screen, if necessary.
2. Touch [••••] to display the 2nd menu. Touch [▶] repeatedly until the audio mode is selected.

Select Subtitle Language

For DVD or Divx discs that contain two or more subtitle languages.

1. During play, touch the screen to display menu on the screen, if necessary.
2. Touch [••••] to display the 2nd menu.
3. Touch [🗨️] repeatedly to select a language. The selected language is displayed.

Change Viewing Angle

Some DVDs contain alternate scenes, such as scenes recorded from different camera angles.

For these DVD disc, you can select from the available alternate scenes.

Press [Angle] repeatedly on the remote control.

The viewing angle is changed.

Video Setup

Touch [🔍] to access video setup mode, touch [⊕] or [⊖] to set the desired effect.



You may set the brightness, contrast, saturation, and hue of the video output from 0 to 20.

Playback Information

Touch the screen when playing back DVD and VCD discs and the playback information will be displayed on the top area of the TFT.

For DVD

1. Disc type.
2. DVD Title information. "1/8" indicates that this DVD has 8 titles and the title playing back now is the first title.
3. DVD Chapter information. "5/12" indicates that current title has 12 chapters and the chapter playing back now is the fifth chapter.
4. Time display



For VCD

1. Disc type.
2. VCD Track information. "1/8" indicates that this VCD has 8 tracks and the track playing back now is the first title.
3. Time display



Elapsed Time

1. Elapsed time of the current track.
2. Total time of the current track.





Playback Mode

Direct Track Entry

To select a track directly, touch the [] icon on screen control to display the direct entry menu. Enter the desired track using the on-screen number pad. Press [OK] to the selected track.





Rotate Pictures

1. When you view pictures, touch the screen to display menu on the screen, if necessary.
2. Touch [] to display the 2nd menu.
3. Touch [] repeatedly to rotate the picture.

Zoom

You can zoom in pictures for a close view.

1. When you view pictures, touch the screen to display menu on the screen, if necessary.
2. Touch [] to display the 2nd menu.
3. Touch [] repeatedly to zoom in or out the picture.

Bluetooth Mode

You can make or receive phone calls with Bluetooth-enabled phones through the unit. You can also listen to music from a Bluetooth-enabled device.

Pair the Bluetooth-enabled Devices

To connect your Bluetooth device to the unit, you need to pair the device to the unit. Pairing needs only to be done once. You can pair up to five devices. You also can search for Bluetooth devices by mobile phone.

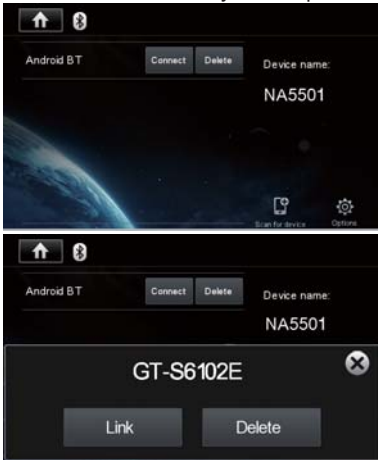

1. Turn on the Bluetooth function on the device.
2. Touch [+] to search for Bluetooth device with the device.
3. Select the Bluetooth device ID in the pairing list.
4. Touch [Link].
5. Enter default password "1234".

Note:

- The operational range between this unit and a Bluetooth device is approximately 5 meters .
- Before you connect a Bluetooth device to this unit, familiarize yourself with the Bluetooth capabilities of the device.
- Compatibility with all Bluetooth devices is not guaranteed.
- Any obstacle between this unit and a Bluetooth device can reduce the operational range.
- Keep this unit away from any other electronic device that may cause interference.

Disconnect Bluetooth Device



To disconnect one device, touch [].



Note:

- The device will also be disconnected when the device is moved beyond the operational range.
- If you want to reconnect the device to the unit, place it within the operational range.
- If you do not want to reconnect the device to the unit automatically, touch [], then set [Auto Connect] to [Off]. For details, see the "Adjust Bluetooth Settings" section.

Make a Call

1. Select Bluetooth function in the home menu.
2. Pair the phone with the unit.
3. Search for phone number from the following list:
 - []: Phone Book
 - []: Call Log
 - [Missed calls]
 - [Received calls]
 - [Dialed calls]

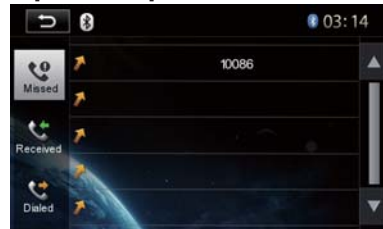

Or touch the number pad directly.

Answer an Incoming Call

By default, all incoming calls are received automatically.

1. If there is an incoming call, "Incoming" will appear on the screen.

Bluetooth Mode



- You may touch the screen to select [Hang up] or [Answer].
Speak into the Bluetooth microphone.

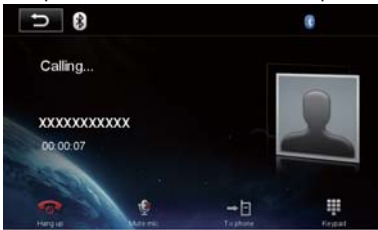

- [Mute mic]: Touch to mute the microphone audio from the unit.
Touch the icon again to restore the microphone audio from the unit.
- [Keypad]: Touch to access the direct dial screen.
- [To phone]: Touch to transfer a call back to the mobile phone.

Note: You can select to receive calls manually by setting [Auto Answer] to [Off] status.

Adjust Bluetooth Settings

- In Bluetooth menu, touch [Settings].
The option menu is displayed.

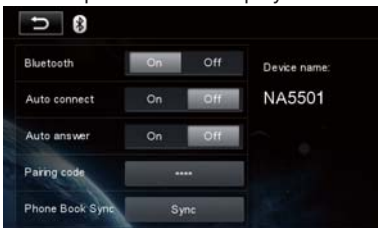

- Touch on the selected option to change the setting.
 - [Bluetooth]: To turn on or off “Bluetooth” function.
 - [Auto Connect]: To turn on or off “Auto

connect” function.

- [Auto Answer]: To turn on or off “Auto answer” function.
- [Pair Password]: To set pairing code.
- [Phone Book]: To synchronize phone book, touch [Download] on the sub-menu popped out.
Phonebook sync may take several minutes to load on initial setup.

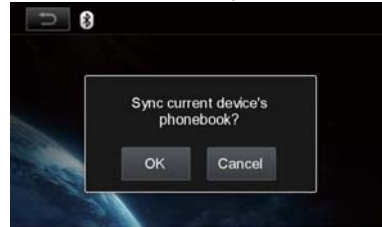

Music Mode A2DP

A2DP is short for Advanced Audio Distribution Profile. The mobile phones supporting this function can transmit stereo audio, whereas the ones not supporting this function can transmit mono audio only.

AVRCP

AVRCP is short for Audio/Video Remote Control Profile. The mobile phones supporting this function can control the playback of a Bluetooth audio player.

To make a call in music playing mode, press the number keys on the mobile phone and the music player will stop. “Calling” will be displayed on the TFT and once the call is received the caller audio will be transferred to the unit. When the call ends, the screen will display the music playing menu.
If there is an incoming phone call, the music player will stop and the screen will display “Incoming Call”. When the call ends, the screen display the music playing menu.



Settings

Display System

1. Touch the upper left corner to display the main menu.
2. Touch [Settings].
The settings menu is displayed.
3. Touch the upper left corner of the screen to exit.

Adjust General Settings

1. Touch [General], if necessary.
2. Touch to select a setting.
3. Touch on the option to display/select an option.

General settings	Options	Description
Radio region	Select one that matches your location : USA/ASIA/JAPAN/EUROPE(LW)/OIRT/EUROPE(FM)/AUSTRALIA/LATIN AMERICA.	
Radio range	Select Distance or Local.	
Blackout	Off	Turn off the Blackout.
	10s	After 10s will Blackout sleep.
	20s	After 20s will Blackout sleep.
Dimmer mode	Touch the [Dimmer mode], there 4 mode to select: Night/Dark/Normal/Bright.	
Beep	On	Turn on the beep sound. Each time you press a button, the unit beeps.
	Off	
Calibration	Touch Star to calibrate the touch screen.	
Key color	Red	You can select the color of the key.
	Green	
GPS path setup	Touch to enter GPS path setup.	

Calibration

When the touch operation is not sensitive or valid, you should calibrate the touch screen using the calibration setting function. Adjust the response positions of the touch panel as follows:

1. Press the [Calibration] option on the setup menu to enter.
2. Touch [Start] to enter.
3. Press and hold the center of [+] for 2 seconds, the [+] will move automatically.
4. Aim at center of [+], follow the path as shown of the figure, after steps from 1 to 5, the system will exit calibrating automatically.

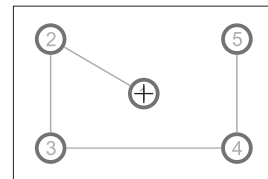

Adjust Video Settings

1. Touch [Video].
2. Touch an option repeatedly to select.

Video settings	Options	Description
Parking	On / Off	Enable video / disable video.

When in Park "On" mode, the screen will display "WARNING" [if you play the video disc]. The above warning screen will prevent the driver from watching images.

Settings

Adjust Sound Settings

1. Touch [Sound].
2. Touch an option repeatedly to select.

Sound settings	Options	Description
Sub Woofer	On/Off	Turn on/off the sub woofer.
Sub Woofer Filter	80Hz	Touch to select a crossover frequency.
	120Hz	
	160Hz	
GPS mixed sound	Rear reduction/Rear normal/Rear mute	Select one of the sound mode.

Adjust Time Settings

1. Touch [Time].
2. Touch an option repeatedly to select.

Time settings	Options	Description
Date	Year/Month/Day	Touch [▲] or [▼] to set year, month and day.
Clock Mode	12H/24H	Touch [12H] or [24H] to switch to time mode.
Time	Touch [▲] or [▼]	to set hour and minutes.

Adjust Language Settings

1. Touch [Language].
2. Touch an option repeatedly to select.

Language settings	Options	Description
OSD	The language or operation interface	Touch to select one language.
DVD audio	The sound language	Touch to select one language if there had.
DVD subtitle	The DVD language	Touch to select one language.
DVD menu	The DVD menu language	Touch to select one language.

Adjust Bluetooth Settings

1. Touch [Bluetooth].
2. Touch an option repeatedly to select.

Bluetooth settings	Options	Description
Bluetooth	On/Off	Touch to select bluetooth on/off.
Auto connect	On/Off	Touch to select auto connect on/off.
Auto answer	On/Off	Touch to select auto answer on/off.
Pairing code	****	Touch to setting the pairing code.
MIC Setting	Inner/Exterior	Touch to select MIC setting.

Adjust DVD Rating

1. Touch [DVD].
2. Touch an option repeatedly to select.

DVD rating	Options	Description
Set Password	----	Set password to restrict the play of discs. The default password is 0000.

Settings

Rating Level	Kid safe	Acceptable for children.
	G	Acceptable for general viewers.
	PG	Parental guidance suggested.
	PG-13	Unsuitable for children under age 13.
	PG-R	Recommend parents to restrict viewing for children under 17.
	R	Restricted re parental guidance is advised for children under the age of 17.
	NC-17	Unsuitable for children under age 17.
	Adult	Acceptable for adults only.
DRC	Touch to select DRC on/off.	
Load factory	Touch to select factory data reset .	

Adjust Volume Settings

You can set different volumes for different modes.

1. Touch [Volume].
The volume setting sub-menu is displayed.
2. Touch on a source.
 - [DVD]
 - [USB]
 - [SDHC]
 - [Radio]
 - [Bluetooth]
 - [AV-IN]
 - [DVB-T]
 - [Navigation]
 - [Rear USB]
3. Touch [▲] or [▼] to assign value: 0 to 12.
When switching to the source, the volume increases automatically.

Other Modes

Listen to Other Devices

You can connect an external audio/video device to the unit.

1. Connect the external device with the supplied AV cable.
2. Touch the upper left corner to display the main menu.
3. Touch [Ori-AUX IN]/[AV-IN] to access external device.

Reset

When the unit hangs up, you can reset it.

Press [RESET] with a ball-point pen or similar tool.

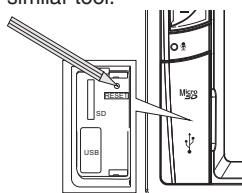

Note:

When the unit has been reset, all the settings will return to default settings.

Replace a Fuse

If there is no power, the fuse may be damaged and need to be replaced.

1. Remove the unit from the dashboard.
2. Check all electrical connections.
3. Buy a fuse that matches the amperage of the damaged fuse.
4. Replace the fuse while the units power is disconnected.

GPS

1. Access General Setting Menu, Select the right Navigation path.
2. Access the Main Menu.
3. Touch "Navigation" icon to access Navigation system.

Steering Wheel Control Programming

1. Touch the upper left corner to display home menu.
2. Touch [SWC], the SWC menu will display.
3. Press each individual steering wheel control button for each corresponding function.

4. Once the final steering wheel control button is programmed, the functions are saved and the programming will end.
5. Touch [Reset] to reset the programming.



TV(Ready)

Touch [TV] in the main menu to switch to TV mode, and touch the center of the screen to show control buttons.

Specifications

General

Reference Supply Voltage.....	12V(DC)
Operating Voltage Range.....	10.5 - 16V(DC)
Max Operating Current.....	15A
Maximum Output Power.....	50W x 4 channels
RMS Power Output	25W x 4 channels
Grounding System.....	Car Battery Negative Pole
Dimensions(LxWXH).....	169X178X101.5mm
Weight(main unit).....	1.82kg

FM

Signal Noise Ratio	≥55dB
Residual Noise Sensitivity (S/N=30dB)	18dBμV
Station Seeking Level.....	20~28dBμV
Distortion	≤ 1.0%
Stereo Separation (1KHz)	≥25dB
Antenna Impedance	75Ω

AM

Residual Noise Sensitivity (S/N=20dB)	30dBμV
Selectivity (±9KHz)	≥ 50dB

LCD

Screen Size	6.8 inches(16:9)
Display Resolution.....	800X480dots
Contrast ratio.....	400

DVD Player

Signal / Noise Ratio	75dB
Dynamic Range	75dB
Distortion (line out)	≤ 0.1%
Frequency Response (±3dB)	20Hz~20KHz
Load Impedance.....	4Ω

AUX IN

Distortion	≤ 0.5%
Frequency Response (±3dB)	20Hz~20KHz
Audio Input Level.....	0.5Vrms

Audio

Audio Output Impedance.....	10KΩ
Audio Output Level.....	4Vrms(Max)

Video

Normal Video Input Level (CVBS).....	1.0±0.2V
Video Input Impedance.....	75Ω
Video Output Impedance.....	75Ω
Video Output Level.....	1.0±0.2V

Environment

Operating Temperature	-10°C ~ +60°C
Storing Temperature.....	-20°C ~ +70°C
Operating Humidity.....	45%~80%RH
Storing Humidity	30%~90%RH

Notice:

When the unit is operated extremely, such as operated with maximum power output for a long time, or the temperature is over 70°C, it will enter heat protection mode, the volume will be lower automatically. This is normal.

Specifications

Supported Formats:

- USB or memory file format: FAT16, FAT32
- Mp3 bit rate(date rate): 32-320 Kbps and variable bit rate
- WMA v9 or earlier
- Directory nesting up to a maximum of 8 levels
- Number of albums/folders: maximum 99
- Number of tracks/titles: maximum 999
- ID3 tag v2.0 or later
- File name in Unicode UTF8(maximum length:128 bytes)

Unsupported Formats:

- Empty albums:an empty album is an album that does not contain MP3/WMA files and is not shown in the display.
- Unsupported file formats are skipped.For example,Word documents(.doc) or Mp3 files with extension.dlf are ignored and not played.
- AAC,WMV,PCM audio files
- DRM protected WMA files(.wav,.m4a,.m4p,.mp4,.aac)
- WMA files in Lossless format

Supported MP3 Disc Format:

- ISO9660,Joliet
- Maximum title number: 512(depending on file name length)
- Maximum album number: 255
- Supported sampling frequencies: 32kHz,44.1kHz,48kHz
- Supported bit-rates: 32-320Kbps and variable bit rates

Supported Video Formats:

- DVD
- MP4
- DivX
- RMVB

Region Code

According to DVD sales regions, the whole world is divided into six regions. A DVD disc can be played back only when its region code is compatible with that of the player in use.

Region 1: USA, Canada, East Pacific Ocean Islands;

Region 2: Japan, West Europe, North Europe, Egypt, South Africa, Middle East;

Region 3: Taiwan of China, Hong Kong of China, South Korea, Thailand, Indonesia, South East Asia;

Region 4: Australia, New Zealand, Mid & south America, South Pacific Ocean Islands/Oceania;

Region 5: Russia, Mongolia, India, Middle Asia, East Europe, North Korea, North Africa, North West Asia;

Region 6: Chinese Mainland.

Precautions when using Discs

1. DO NOT use irregular shaped discs.
2. Disc cleaning:
Use a dry, soft cloth to wipe the disc from center to edge, only neutral detergent can be used.
3. When playing a new disc:
New discs may have some rough spots around the inner and outer edges. If such a disc is used, remove these rough spots with a pencil or ball-point pen, etc.

Troubleshooting

What appears to be a problem is not always serious. Please check the following points before calling a service center.

Problem	Cause	Corrective action
General		
Unit does not power on	Unit fuse blown.	Install new fuse with correct rating.
	Car battery fuse blown.	Install new fuse with correct rating.
	Illegal operation	Reset the unit.
Remote control does not work	Battery depleted.	Change the battery.
	Battery installed incorrectly.	Install the battery correctly.
No/low audio output	Improper audio output connection.	Check wiring and correct.
	Volume set too low.	Increase volume level.
	Speakers damaged.	Replace speakers.
	Heavily biased volume balance.	Adjust the channel balance to center position.
	Speaker wiring is in contact with metal part of car.	Insulate all speaker wiring connections.
Poor sound quality or distortion	Pirated disc is in use.	Use original disc.
	Speaker power rating does not match unit.	Replace speakers.
	Wrong connections.	Check wiring and correct.
	Speaker is shorted.	Check wiring and correct.
Unit resets itself when engine is off	Incorrect connection between ACC and BATT.	Check wiring and correct.
TFT monitor		
Warning information is shown at all times	Parking break wiring is not correct.	Check wiring and correct.
Flashing image or interference appears on screen	The color system of DVD disc does not match the monitor.	Adjust the color system of the DVD disc playing back or the monitor in use.
	Pirated disc is in use.	Use original disc.
	Video cable damaged.	Replace cables.
	Improper video signal connections.	Check wiring and correct.
Disc playback		
Cannot insert disc	A disc is already inside the unit.	Eject current disc and insert new one.
Disc does not play back	Disc is warped or scratched.	Use disc in good condition.
	Disc is dirty or wet.	Clean disc with soft cloth.
	Incompatible disc is used.	Use compatible disc.
	Disc is inserted upside down.	Insert disc with label side up.
	Disc region code is not compatible with unit.	Use disc with proper region code.
PBC cannot be used during VCD playback	PBC is not available on the disc.	Use disc with PBC available.
Repeat or search function is invalid during VCD playback	PBC is on.	Turn PBC off.
Error messages		
No disc	Disc is dirty.	Clean disc with soft cloth.
	Disc is upside down.	Insert disc with label side up.
	No disc inside.	Insert disc.
Bad disc	Disc is dirty.	Clean disc with soft cloth.
	Disc is upside down.	Insert disc with label side up.
Unknown disc	Disc format is not compatible with this unit.	Use disc with compatible format.
Region error	DVD region code is not compatible with this unit.	Use disc with compatible region code.



Installation

Disconnecting the Battery

To prevent a short circuit, be sure to turn off the ignition and remove the negative (-) battery cable prior to installation.

Note:

If the unit is to be installed in a car equipped with an on-board drive or navigation computer, do not disconnect the battery cable. If the cable is disconnected, the computer memory may be lost. Under these conditions, use extra caution during installation to avoid causing a short circuit.

Remove Transport Screws

WARNING! Remove these two transport screws before installation. Otherwise, the DVD player will not work.

Replacing the Fuse

When replacing the fuse, use a new 15A replacement fuse. Using a fuse with an improper rating could damage the unit and cause a fire.



Wire Connections

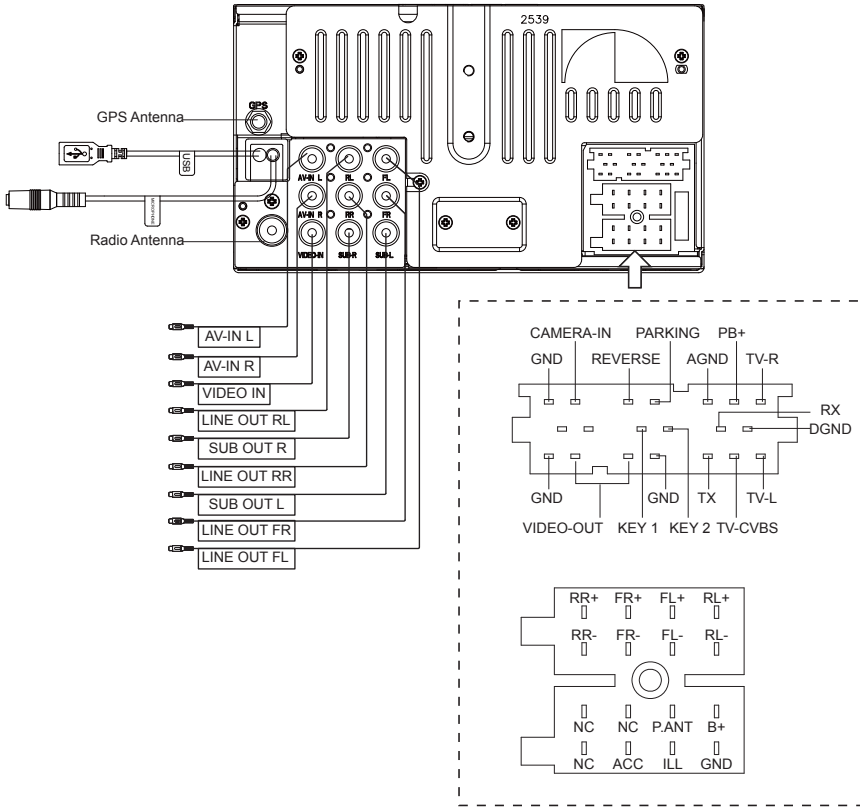

Quick Start Guide

1 What's in the box

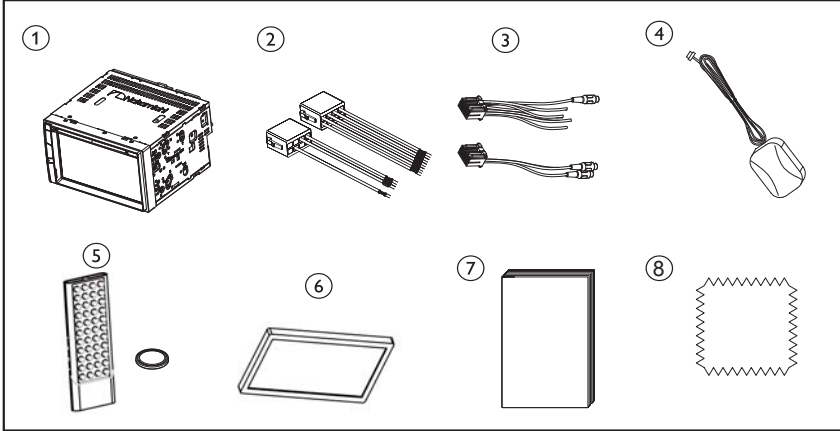

Check and identify the contents of the package:

- | | | |
|--------------------------|----------------------------|---------------|
| 1 Main unit | 4 GPS WIRE | 7 User manual |
| 2 ISO male connector X 2 | 5 Remote control & battery | 8 Clear cloth |
| 3 CAM+VOUT CAM+SWC+VIDEO | 6 TRIM | |

2 Nakamichi Recommend 4.1 audio connection

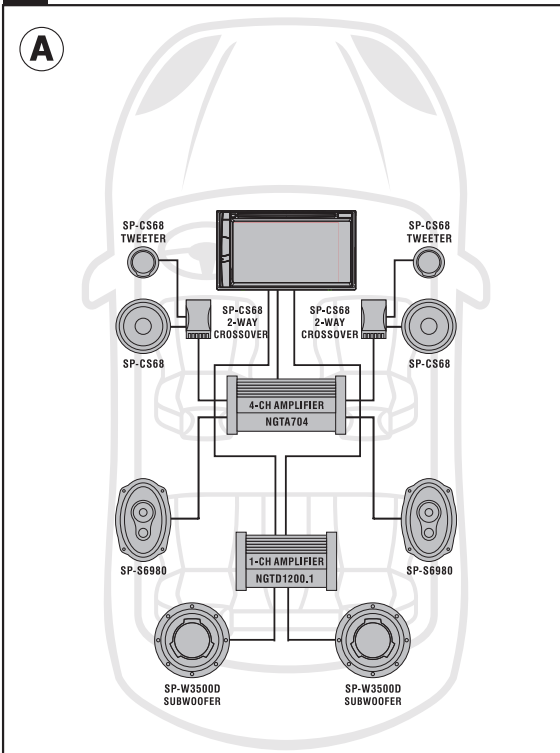

Quick Start Guide

3 Connecting the System

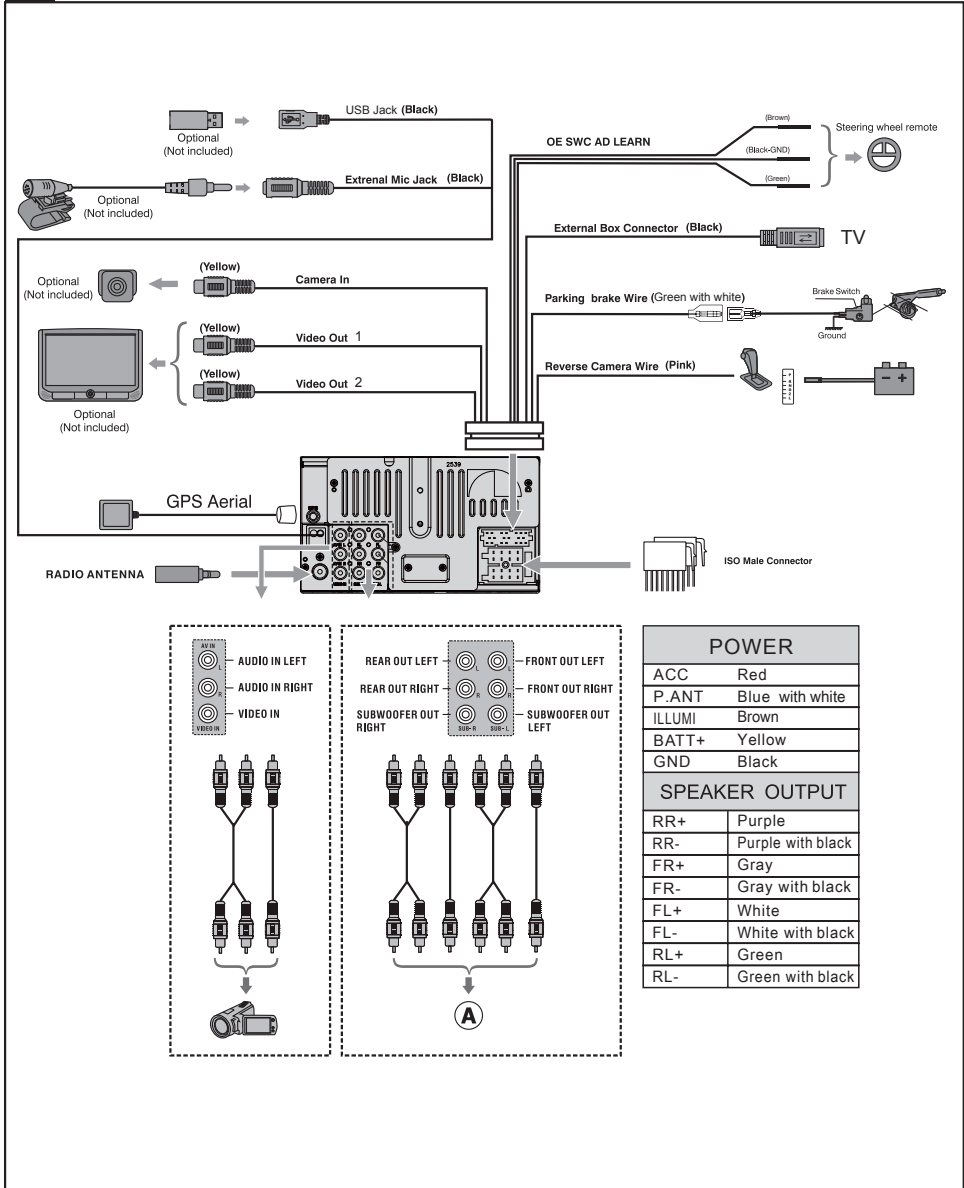

Quick Start Guide

4 Mount Into The Dashboard

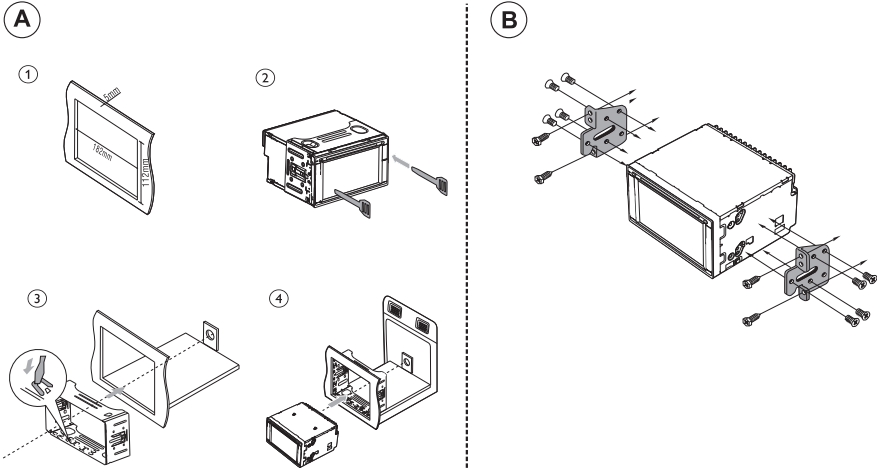

! All the mounting sleeve & screw are not included in this packing.

5 Microphone

1. Panel Built-in Microphone

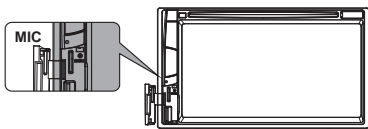

2. External microphone

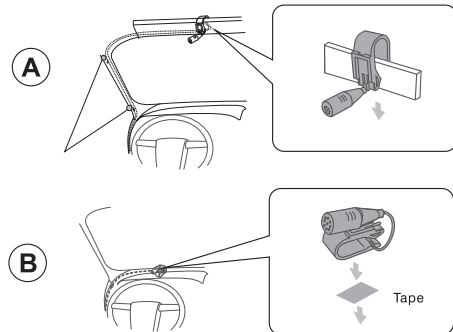

! External microphone not supplied with this unit.

Quick Start Guide

6 SD/SDHC Media Playback

Insert SD/SDHC card

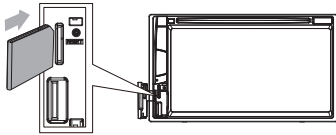

7 Battery Charge Smartphone

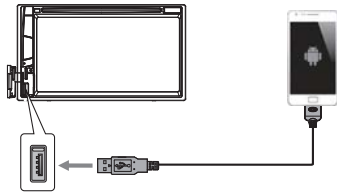

⚠ Do not switch to USB mode while charging smartphone. Do not supplied the connect line.

8 GPS Connection

Insert GPS Map Card (TF Card Only)

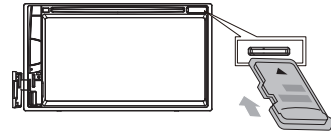

⚠ Please switch off the unit before insert the GPS map card.

Install The GPS Smart Antenna

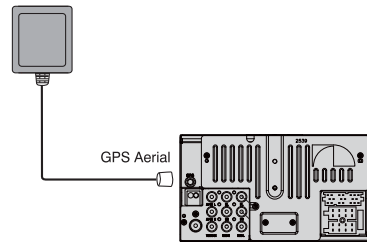

⚠ Antenna supplied with this unit.

When Installing The Antenna Inside The Vehicle

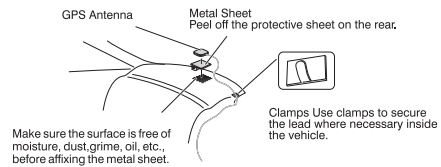

⚠ The metal sheet contains a strong adhesive which may leave a mark on the surface if it is removed.

Quick Start Guide

9 OE Steering Wheel

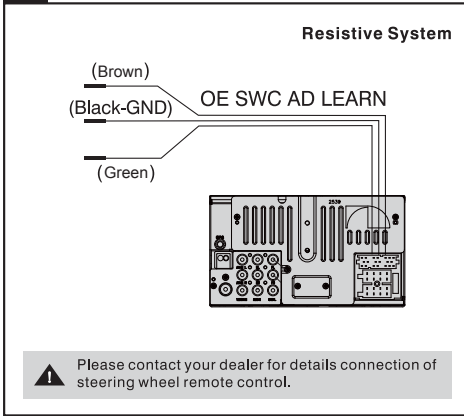

10 External Box Connection

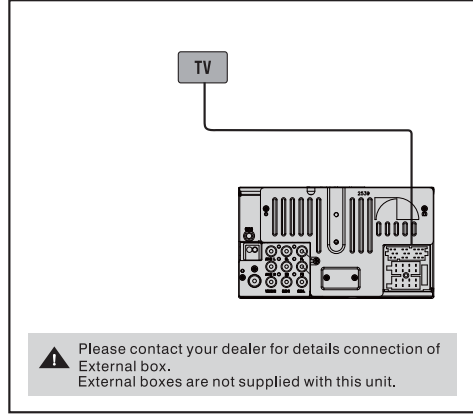

11 Reset The System

If the system hangs up, Please reset it.

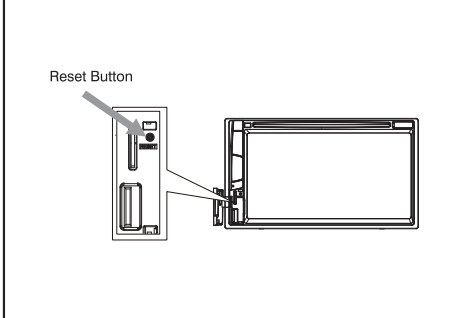



支持 CD/DVD/MP3/RADIO/RDS
支持藍牙 / 導航 / 方向盤控制

型號 : NA5501



使用說明書

安全警告

感謝您購買本產品，為了幫助您更好的了解及使用本產品，請在使用前仔細閱讀產品使用手冊，並保存以備將來查驗。

本機用於備有 12V 電壓的負極接地電池系統的汽車中，請勿直接將本機安裝在 24V 電池的卡車或公共汽車上。



請勿將本機安裝在有礙駕駛視野或影響駕駛操作的地方。



為避免因分散駕駛注意力造成交通事故，駕駛員不要在駕駛時操作本機或觀看播放畫面，確需操作請將車停在安全的地方。



駕駛時請將音量調到適當大小，音量過大會干擾駕駛員聽取車外的緊急呼叫聲。

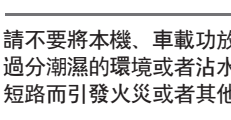

請不要將本機、車載功放及揚聲器等暴露在過分潮濕的環境或者沾水，否則會造成電氣短路而引發火災或者其他損害。



請不要擅自更換本機所附電源連接器上的保險絲裝置，換成不匹配的保險絲會喪失對本機的過電流的保護作用，可能會燒毀本機甚至引發火災。

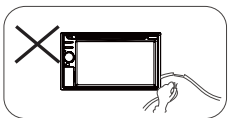

請立即停止使用本機，並送往購買處或售后服務中心維修；若繼續使用則可能導致火災或其他事故。如果本機出現以下狀況：

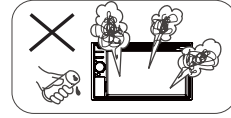

- (a). 沒有聲音
- (b). 沒有圖像
- (c). 有水或者其它障礙物進入機內
- (d). 出現冒烟
- (e). 有臭味

* 出現在本手冊中的插圖是為了更清楚地說明如何進行操作，因此插圖可能與本機的實際顯示不同，請以實物為準。

警告

本機由高精密部件組成，請勿擅自拆開機蓋或調整任何部件，確需維修請到附近的專業售后服務中心接受服務。

謹慎光碟的使用

1. 不能使用形狀不規則的光碟。

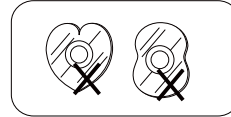

2. 光碟清潔：要用一塊乾淨的軟布擦拭污的碟片，擦拭時要從中心向外擦。不要用酒精或是汽油之類的溶劑擦拭。

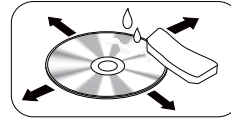

3. 新碟片內、外側可能會比較粗糙，請用鉛筆或鋼筆等沿光碟邊緣轉動，以延長播放器壽命。

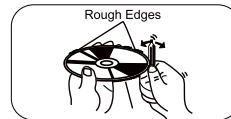

安全警告

1. 不要在沒有專業人員的指導下拆卸或改裝主機。
2. 如果面板或液晶顯示器臟了，請用干淨的硅布和中性清潔劑清潔。用粗糙的布和非中性洗滌劑如酒精清洗可能會劃傷顯示器使顯示器變色。
3. 如果主機不能正常工作，請參閱本手冊的故障排除指南。如果沒有發現相關信息請按前面板的復位按鈕恢復出廠默認設置。
4. 如果您在高溫或冰冷天氣下停車很長一段時間，請等待車內氣溫恢復到常溫后才操作主機。
5. 在低溫環境下使用汽車加熱器可能導致主機內部潮濕，請不要在這種情況下使用主機。當內部有水氣請彈出碟片，擦拭光盤上的水份，如果幾個小時后主機仍不能工作，請聯系客服中心。
6. 不要故意猛擊屏幕，這樣會損壞它。
7. 為防止損壞屏幕，避免與尖銳物品觸碰。
8. 插圖是用來提供一個明確的示範和一個簡單的方法來了解如何操作這臺主機的，當然有些插圖可能會跟主機顯示的實際圖像不同。
9. 請按照本手冊正確操作主機，違規不當操作將會使保修失效。

擴展系統

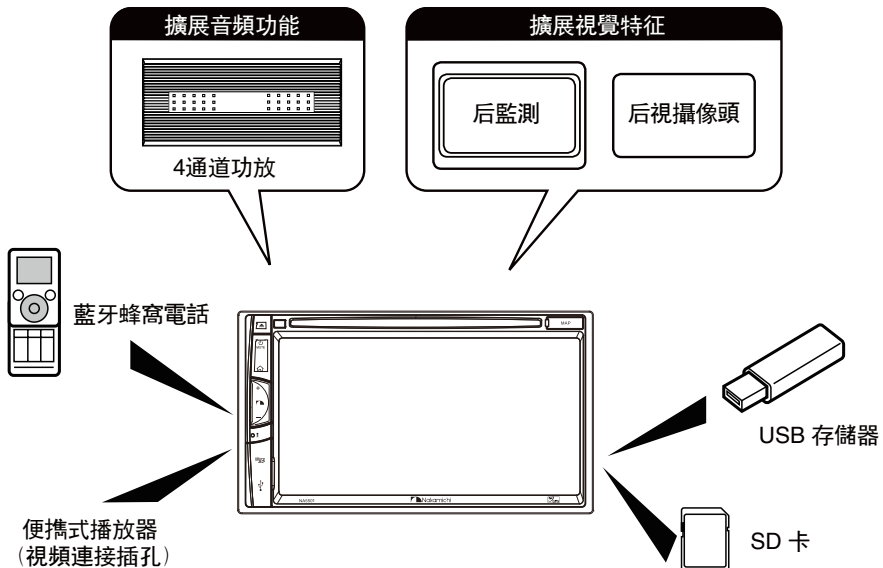

 注意：外面的框架中列出的項目產品通常都有出售。

目錄

安全警告	34	調整藍牙設定	48
目錄	36	手機音樂	48
面板操作	37	調整設定	50
遙控器	38	通用設定	50
基本操作	40	屏幕校準設定	50
語言選擇	40	視頻設定	50
開 / 關機	40	聲音設定	51
靜音	40	時間設定	51
調節音量	40	語言設定	51
進入主桌面及其功能簡介	40	藍牙設定	51
時間設定	40	碟片設定	52
調整音效	41	音量設定	52
調整揚聲器平衡	41	其它	53
收音	42	外接輸入設備使用	53
進入收音機播放	42	系統初始化	53
選擇波段	42	更換保險絲	53
手動調臺	42	導航功能	53
自動調臺	42	TV (選配設備)	53
手動輸入電臺頻率	42	方向盤控制	54
手動存儲電臺	42	設備連接	55
自動搜索電臺	42	安裝	56
掃描預設電臺	43	產品信息	56
選擇預設的電臺	43	故障排除	58
遠距 / 近距選擇	43	電氣連接圖	59
EQ	43	快速安裝指引	60
RDS 概述	43		
調節 RDS 設置	43		
RDS/AF/EON/TA/CT/PTY 功能	43		
播放	44		
插入光碟	44		
退出碟片	44		
視屏播放觸摸按鍵分布	44		
SD/ 前置 USB 裝置	44		
播放控制菜單	44		
播放 / 暫停	45		
上一曲 / 下一曲	45		
文件夾選擇	45		
重復播放	45		
重復 A-B 片段	45		
隨機播放	45		
選擇音頻模式	45		
選擇字幕語言	45		
畫質調整	46		
進度條	46		
曲目選擇	46		
旋轉圖片	46		
縮放圖片	46		
藍牙	47		
藍牙配對	47		
斷開藍牙連接	47		
撥打電話	48		
接聽電話	48		

面板操作

按面板上的  鍵開機。

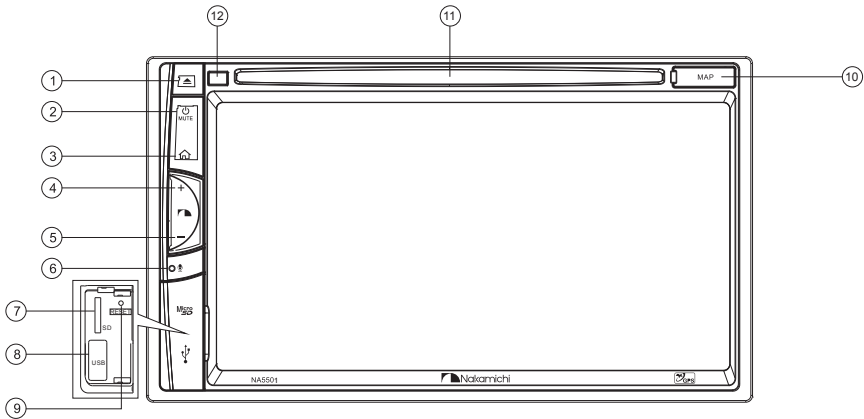

注：圖片僅供參考，請以實物為準。

- 1. [⏏] 按鍵：彈出鈕**
按彈出鈕彈出碟片，如果10秒鐘不拿走碟片，碟片將會重新自動進入主機內。
- 2. [⏻] 旋鈕：**
短按開啟主機；長按關閉主機。
在開機狀態短按為靜音，解除靜音需要再次短按此鍵。
- 3. [☰] 主菜單鍵**
- 4. [+] 按鍵：增加音量。**
- 5. [-] 按鍵：減少音量。**
- 6. 麥克風**
- 7. SD 卡插槽**
SD 卡插槽，只播放多媒體文件。插入一個 SD 卡，主機將會自動開始閱讀和回放卡內文件。
- 8. USB 插槽**
USB 插槽，只播放多媒體文件。插入一個 USB，主機將會自動開始閱讀和回放 USB 內文件。
- 9. 復位鈕**
用尖利且細小的工具按此按鈕，產品將重置為工廠默認設置。
- 10. GPS 插槽**
插入一張 GPS 地圖卡，主機將會開始進行導航功能。
- 11. 碟片插槽**
- 12. 遙控接收窗**

遙控器

遙控範圍

遙控器的最大可操作範圍約 3 ~ 5 米。

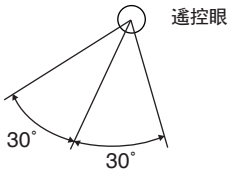

按 鍵開 / 開機。

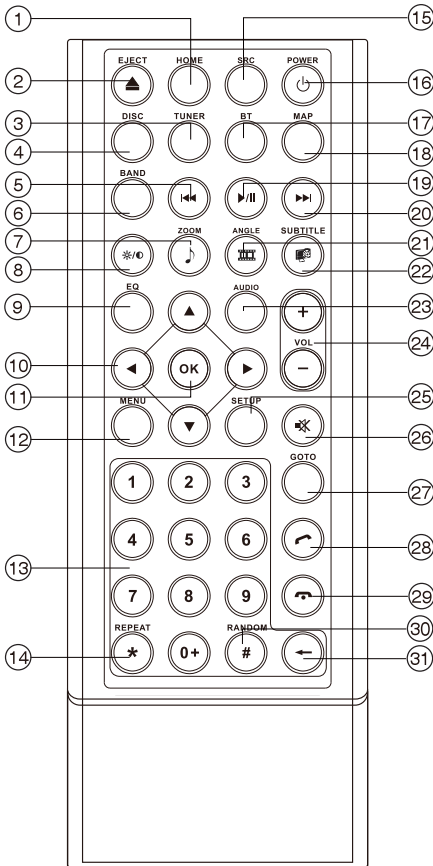

1. 轉到主菜單
2. 出碟
3. 轉到收音
4. 轉到碟片
5. 向上搜臺
回到上一章節
6. 選擇收音波段
7. 放大 (DVD/VCD 視頻菜單)
音樂菜單 (音頻菜單)
8. 調整屏幕設置
9. 打開音效菜單
10. 菜單搜索
11. 確認
12. 打開路徑菜單 (DVD)
開/關 PBC (VCD)
13. 數字鍵
14. 重複播放
15. 轉到下一個播放源
16. 關閉鍵
17. 轉到藍牙功能鍵
18. 轉到導航功能鍵
19. 暫停/開始
20. 向下搜臺
回到下一章節
21. DVD 角度選擇
圖片旋轉
轉到視頻清單
22. DVD 字幕語言選擇
圖片清單
23. 改變音頻語言 (DVD)
24. 音量調節
25. 進入設置菜單
26. 音頻輸出靜音開關
27. 直接跳轉曲目模式
28. 撥號/接聽 電話
29. 掛機
30. 隨機播放
31. 短按逐個清除數字
長按清除所有數字

遙控器

更換遙控器電池

當遙控器操作範圍變小或無反應時，請更換新電池。更換時要確保電池兩極方向正確。

1. 按住遙控器背面箭頭位置，將電池蓋向下推動到圖 1 所示位置，然後取下。
2. 取出舊電池，然後正極向上裝入新的鋰電池 (CR2025)(3V)，如圖 2。
3. 裝上電池蓋，向上推動直至閉合，如圖 3。

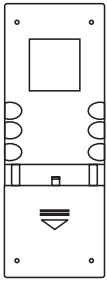

↓ 圖 1



圖 2



↑ 圖 3

警告：

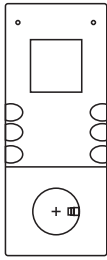
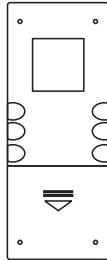
- 電池應放在兒童接觸不到的地方。如果意外誤食電池，須立即就醫。
- 不要將電池充電、短路、過熱或投入火中，否則會導致電池過熱、爆裂或着火。
- 不要把電池同金屬物質放在一起，否則會導致電池過熱、爆裂或着火。
- 當丟掉或取出電池保存時，用紙包住隔離，否則會導致電池過熱、爆裂或着火。

基本操作

語言選擇

1. 首次裝機使用或使用過程中進行硬件復位會出現語言選擇界面。
請選擇一種您所熟識的語言，然後進入本機操作界面。



2. 您也可以通過設置菜單選擇語言。

開 / 關機

開機：按 [⏻] 按鍵啟動主機。

關機：在工作模式下，長按 [⏻] 按鍵即可關機。

靜音

播放時，短按 [⏻] 按鍵進入靜音模式。
要重新打開聲音，請再次輕按 [⏻] 按鍵。

調節音量

輕觸 [+] 按鍵 (或按遙控器 VOL+) 增大音量，
輕觸 [-] 旋鈕 (或按遙控器 VOL-) 減小音量。
調節時屏幕會顯示音量指示條，音量調節的範圍從 0 到 50。

進入主桌面及其功能簡介

開機狀態，系統默認進入收音狀態下，輕觸收音界面的左上角，進入主桌面 (如下圖所示)。



- ① 功能圖標
- ② 向左 / 向右滾動菜單 (也可以在屏的界面空白處左右滑動實現左右滾動主桌面)
- ③ 進入設置菜單功能
- ④ 日期時間顯示
- ⑤ 快速進入 EQ 設定

時間設定

1. 輕觸桌面的 [設置] 圖標。
2. 輕觸 [時間]。
↳ 將顯示日期 / 時鐘模式 / 時間 / 時區設置設定菜單。



- 設定日期
 1. 輕觸 [日期]。
 2. 輕觸所顯示的日期信息。
↳ 將顯示子菜單。
 3. 輕觸 ▲ 或 ▼，設定年、月、日。
 4. 設定完畢後，輕觸 [保存] 確定；輕觸 [取消] 則取消您當前的設定。
- 設定時間模式
輕觸 [時鐘模式] 可進行 12 小時制、24 小時制切換。
- 設定時間
 1. 輕觸 [時間]。
 2. 輕觸所顯示的時間。
↳ 將顯示子菜單。
 3. 輕觸 ▲ 或 ▼，設定小時、分鐘。
如當前為 12 小時的時鐘模式，可設定 AM(上午) 或 PM(下午)。

基本操作

調整音效

輕觸主桌面下方的 [EQ] 圖標，快捷進入音效設置，詳見以下操作：

輕觸 [EQ]，將顯示以下選項 (如下圖所示)：



- 1) 選擇預設音效
[舒適]/[古典]/[搖滾]/[爵士]/[輕快]/[流行]
以上是系統已預設完成的音效，根據您的需要進行選擇。
- 2) 手動設置均衡器
輕觸均衡器上下兩邊可以調節各個頻段的參數。
- 3) 輕觸 [重置] 恢復為默認設置。

調整揚聲器平衡

您可以調整前置和後置揚聲器平衡、左右揚聲器平衡以及低音揚聲器設置。

輕觸 [揚聲器平衡]，將顯示以下選項 (如下圖所示)：



- 1) 輕觸 [▲]/[▼] 或滑動滾動條都可以調節重低音揚聲器的音量。
[重低音] 低音揚聲器音量：0 至 30。
- 2) 輕觸 ▲、▼、◀ 或 ▶ 以調整漸弱 / 平衡值。
[前後] 漸弱範圍：前 20 至後 20。(▲ = 前置揚聲器，▼ = 後置揚聲器)
[左右] 平衡範圍：左 20 至右 20。(◀ = 左揚聲器，▶ = 右揚聲器)



也可在此區域任意輕觸調整揚聲器平衡值。

收音

進入收音機播放

進入主桌面，輕觸的 [收音機] 圖標，進入收音機模式。

※ 提示：

1. 如當前播放的電臺是立體聲時，[立體聲] 圖標呈高亮，立體聲只限於 FM 波段。
2. 在收音界面上，輕觸界面左下角的 [●●●●] 圖標，彈出所有功能圖標，此時左下角的 [●●●●] 切換成 [∨] 圖標，再次輕觸 [∨] 圖標將隱藏第二行功能圖標。

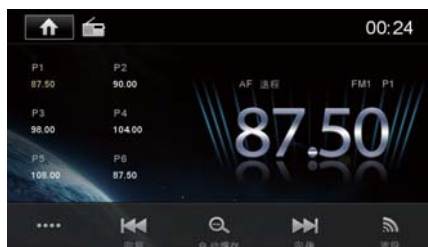

選擇波段

輕觸 [📶]，在 FM 或 AM 中切換選擇波段：

- FM 波段選項：FM1、FM2、FM3
- AM 波段選項：AM1、AM2

手動調臺

手動調臺時，逐步選擇頻率。

輕觸 [⏪] 或 [⏩] 圖標，可以調到頻率更高 / 更低的電臺。

自動調臺

長按 [⏪] 或 [⏩] 圖標，自動搜索更高 / 更低的有效電臺。

手動輸入電臺頻率

1. 輕觸 [🔢]，進入數字鍵盤輸入界面。
2. 輕觸數字以輸入有效頻率。
3. 輕觸 [OK] 確認。
輕觸 [✖] 清除輸入的數字。



手動存儲電臺

1. 當調到所需的電臺時，輕觸 [↓]，進入保存頻率列表界面。
2. 長按預設電臺列表 P1 ~ P6，將當前電臺儲存。
3. 輕觸 [↶]，退出此界面。



自動搜索電臺

長按 [🔍] 圖標，系統將自動搜索到有效電臺并自動保存。

收音

掃瞄預設電臺

輕觸 [] 圖標，自動掃瞄當前波段的預設電臺，每個電臺瀏覽播放 5 秒，自動掃瞄完畢后系統自動退出掃瞄界面。

選擇預設的電臺

輕觸預設電臺列表中的 P1 ~ P6，即可收聽預設電臺。

遠程 / 本地選擇

輕觸 [] 圖標，遠程 / 本地切換功能。

[遠程]：可以接收較弱信號電臺；

[本地]：只接收信號較強電臺。

EQ

輕觸 [] 圖標，進入 EQ 設定界面（詳見基本操作章節）。

RDS 概述

RDS 數據傳輸到收音電臺，屏幕將顯示信息歌曲演唱者和歌曲名稱的電臺。

如果 RDS 服務在您的區域不可用，以下的設置不可用。



調節 RDS 設置

在收音菜單下，輕觸 [] 圖標。顯示 RDS 設置菜單。

- [RDS]: 打開或關閉“RDS”功能。
- [AF]: 打開或關閉“AF”功能。
- [EON]: 打開或關閉“EON”功能。
- [TA]: 打開或關閉“TA”功能。
- [CT]: 打開或關閉“CT”功能。
- [PTY]: 進入節目類型清單。

RDS (無線電數據系統)

本機具有 RDS 的基本功能。RDS 服務具有區域性。如果 RDS 服務在您的區域不可用，以下的設置不可用。

AF 功能

如果從當前電臺接收的不良信號電臺，您可以打開 [AF] 功能讓本機搜尋信號更強但具有相同節目編號的其它電臺。

EON (增強型其它網絡)

當接收到 EON 數據，EON 指示燈點亮，TA 和 AF 功能加強。TA: 可以收到本地電臺和其他網絡中本臺的信息。AF: 根據 EON 數據，RDS 預設的頻點會相應更新。EON 使收音充分使用 RDS 信息。它不停的更新預設電臺的變動清單，并包括當前使用的電臺。如果你預存一個你家周圍的電臺，后面你會收到一個變頻的同一個電臺，或者其他播放相同節目的電臺。EON 實時跟踪 / 快速接收當地交通信息臺。

TA 功能

如果您在欣賞音樂時不想錯過交通廣播，則可以打開 [TA] 功能。發布交通廣播時，本機會切換到調諧器模式（無論當前處於什麼模式）開始廣播關於交通狀況的公告。交通廣播結束後，本機返回到原模式。

CT (時鐘)

有些電臺在 RDS 編碼信號中發送時間和日期信息。當 CT 設置打開時，時間會自動調整。

PTY 功能

PTY 是正在播出具有決定性節目類型的類型代碼（如新聞或搖滾樂）的縮寫。

PTY 選項會顯示在屏幕上。輕觸屏幕上的滾動條，可查看更多 PTY 選項。

當一個 PTY 選項被觸摸（如新聞），本機會通過增加調諧頻率自動尋找下一個可用的 PTY，直到查找到下一個 PTY 匹配的電流。如果沒有發現匹配的 PTY，本機將返回到原來的無線電頻率。

播放

插入光碟

您可以播放儲存在以下光碟上的視頻、音頻或圖像：

DVD-5、DVD-9、DVD-10、DVD-18、
DVD+/-R、DVD+/-RW

CDDA、CD+/-R、CD-RW、VCD、SVCD
將光碟插入光碟插槽，印刷面朝上，播放將自動開始。

※ 提示：本機不保證兼容所有碟片，只支持規格為 12CM 光碟，不支持 8CM 光碟。

退出碟片

輕按面板上的 [▲] 鍵出碟。

↳ 光碟退出后，本機將切換至光碟進入前的模式。

視屏播放觸摸按鍵分布

當播放圖片或視屏時，在屏幕上的功能區域分布如下圖所示：

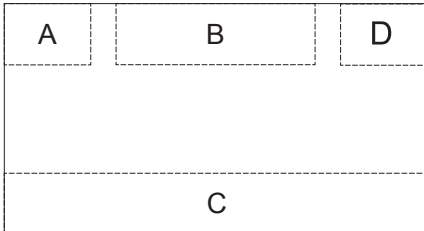

- A 區：返回主桌面
- B 區：顯示播放資訊
- C 區：屏幕控制按鍵
- D 區：時間顯示

SD/ 前置 USB 裝置

連接

- 1、打開 SD/ 前置 USB 保護蓋。
- 2、將 SD/USB 裝置插入 SD/ 前置 USB 接口，將自動開始播放。

移除

- 1、切換至另一個音源。
- 2、移除外部 USB/SD 裝置。

※ 提示：

- 1) 本機不保證兼容所有 USB/SD 裝置。
- 2) 前置 USB 可支持部分安卓手機充電 (1A)

- 功能。
- 3) 當使用后置 USB 請到功能界面中操作進入。

播放控制菜單

在播放界面上，輕觸除屏幕左上角之外的任何區域都可彈出控制菜單（再次輕觸屏幕即可隱藏控制菜單），輕觸界面左下角的 [●●●●] 圖標，顯示隱藏的所有功能圖標，此時左下角的 [●●●●] 切換成 [∨] 圖標，再次輕觸 [∨] 圖標即時收起第二行功能圖標。



播放

播放 / 暫停

1. 播放時，輕觸 [⏸] 圖標暫停播放。
2. 再輕觸 [▶] 圖標繼續播放。

上一曲 / 下一曲

輕觸 [⏮] / [⏭] 圖標，可選擇上一曲、下一曲。
長按為連續快進退功能。

文件夾選擇

· 選擇視頻文件

1. 輕觸 [📺] 顯示所有可用的視頻文件。
2. 選擇一個文件夾，進入選擇您想要的文件。
3. 輕觸此文件播放開始。

· 選擇音頻文件

1. 輕觸 [🎵] 顯示所有可用的音頻文件。
2. 選擇一個文件夾，進入選擇您想要的文件。
3. 輕觸此文件播放開始。

· 選擇圖片文件

1. 輕觸 [🖼️] 顯示所有可用的圖片文件。
2. 選擇一個文件夾，進入選擇您想要的文件。
3. 輕觸此文件播放開始。

重復播放

播放時，您可以選擇不同的循環播放模式，反復輕觸 [🔁] 功能圖標執行重復播放模式。

- 對於 CD/MP3 文件，執行重復時所呈現的圖標解釋如下：

- [🔁]：重復播放當前曲目。
- [🔁]：重復播放所有的曲目播放。
- [🔁]：重復播放當前文件夾的曲目。
- [🔁]：取消重復播放。

- 對於 DVD/VCD 文件：

- ① 根據需要，輕觸除屏幕左上角之外的任何區域可顯示控制菜單。
- ② 反復輕觸 [🔁] 圖標，根據播放文件格式不同，重復功能的選擇也不同，執行重復時所呈現的文字解釋如下：
[單曲重復]：反復播放當前曲目。

- [目錄重復]：反復播放目錄的曲目。
- [重復全部]：反復播放全部曲目。
- [章節]：反復播放當前章節。
- [標題]：反復播放標題中的所有章節。
- [關]：取消重復播放。

重復 A-B 片段

播放 VCD、DVD 時可以設定片斷 A-B 重復播放，輕觸 [A-B] 功能圖標流程如下圖：

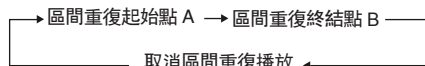

- [重復 A-]：設定重復始點
- [A-B 重復]：設定重復終點
- [取消重復]：退出重復 A-B 模式

隨機播放

播放音頻時，可以隨機順序播放所有曲目，輕觸播放界面下方的 [🎲] 功能圖標，開始隨機播放。

- [🎲] 高亮：隨機播放。
- [🎲] 復原：順序播放。

選擇音頻模式

播放 VCD/DVD 碟片時，如果 VCD/DVD 碟片中錄制了多種對白語言，輕觸 [🗣️] 圖標，可以切換對白語言。



- DVD
反復輕觸 [🗣️]，屏幕上方將顯示播放聲音語言，根據碟片本身包含的語言選擇。
例如：中文、英文等。
- VCD
反復輕觸 [🗣️]，屏幕上方將顯示聲道信息，可以切換 "左聲道"/"右聲道"/"立體聲"。

選擇字幕語言

對於包含兩種或多種字幕屏語言的 DVD 光碟。播放 DVD 碟片時，對視頻中的字幕進行切換，反復輕觸 [🗣️] 圖標，可以切換字幕的語言。
※ 提示：只有在 DVD 碟片模式下可以切換字幕語言。

播放

畫質調整

- 1、輕觸 [] 功能圖標將進入畫質調節模式，輕觸 [] 或 [] 可調節亮度、對比度、飽和度、色度。
- 2、輕觸調光區域外的區域即可退出畫質調節模式。



時間，您可以直接輸入數字進行選擇歌曲播放。



旋轉圖片

- 1、根據需要，在查看圖片時輕觸屏幕圖片功能顯示菜單。
- 2、反復輕觸 [] 可順時針旋轉圖片。



進度條

在播放音頻 / 視屏時，可以通過拖動播放界面的進度條控制當前播放節點，可隨意選擇您所需要的播放節點。





縮放圖片



您可以放大圖片以便清楚地查看。根據需要，在查看圖片時輕觸屏幕圖片功能顯示菜單。

- []：放大 / 縮小圖片
- []：還原圖片原來的大小

曲目選擇

- 對於 CD/MP3 文件：
 - ①輕觸左下角觸摸鍵可顯示控制菜單。
 - ②輕觸 []，將顯示選曲界面，您可以直接輸入數字進行選擇歌曲播放。
[OK]：確認。
[]：刪除輸入的內容。



- 對於 DVD/VCD 視屏文件：
 - ①輕觸除屏幕左上角之外的任何區域可顯示控制菜單。
 - ②輕觸 []，將顯示選曲界面。
 - ③輕觸 [] 可選擇章節、標題、

藍牙

※ 提示

為了您的安全，避免在開車時通電話。
本機具備藍牙無線傳輸功能，可連接市場上主流的、具有藍牙功能的手機等設備。藍牙配對成功后，可通過本機撥號 / 接聽等功能，還可以播放手機中的音樂。

藍牙配對

要將手機連接至本機，您需要將該手機與本機配對。

1. 打開手機的藍牙功能（本機藍牙功能默認是開啟）。
2. 用手機搜索到本機藍牙，本機藍牙裝置名會顯示在您的手機藍牙配對列表上；也可用本機藍牙搜索手機，搜索到的手機名會顯示到本機藍牙配對列表上。
3. 搜索成功后，輕觸本機藍牙名，按手機的提示輸入藍牙配對密碼“1234”，即可與本機藍牙配對。
4. 配對成功后，本機屏幕上即顯示被配對的藍牙型號名，操作顯示界面如下。

※ 提示

- ① 本機與手機之間的操作範圍：小於5米。
- ② 在將手機連接至本機之前，您需要熟悉設備的藍牙功能，本機不保證兼容所有的手機。
- ③ 本機與手機之間的任何障礙物都會使操作範圍縮小。



1. 返回主桌面
2. 藍牙配對列表
3. 調整藍牙設定
4. 搜索手機
5. 顯示本機名稱
6. 顯示當前系統時間
7. 連接選中的手機
8. 刪除選中的藍牙裝置名
9. 退出藍牙連接選擇界面
10. 進入藍牙音樂操作界面
11. 進入撥打電話操作界面
12. 電話號碼輸入顯示區
13. 數字符號功能鍵（可通過數字鍵輸入呼叫的號碼）
14. 進入手機的電話本界面（需電話本同步）
15. 撥打電話
16. 進入手機的通話記錄界面
17. 斷開連接
18. 顯示被配對的手機名
19. 刪除前面電話號碼輸入區號碼

斷開藍牙連接



要斷開手機藍牙連接，請輕觸 [] 圖標或關閉手機的藍牙功能。

※ 提示：

- ① 當裝置移至操作範圍之外時，藍牙連接也會斷開。
- ② 如果您想將手機重新連接至本裝置，將其置於操作範圍之內即可。
- ③ 如果您不想讓手機自動重新連接至本裝置，請輕觸藍牙設定 [] 圖標 > [自動連接]，然後選擇 [Off]。有關詳細信息，請參閱“調整藍牙設定”部分。

藍牙

撥打電話

- 1、輕觸 [] 進入連接的藍牙界面，輕觸 []，進入藍牙電話本，根據您的所需，輕觸 [] 圖標進入快速查尋電話號碼界面；







或輕觸 []，進入最近 [未接]、[已接]、[已撥] 的通話記錄，快速查尋到最近通話聯絡的人；



或直接通過數字鍵區域輸入電話號碼。

- 2、選中號碼后，輕觸電話號碼或 []，即可進入通話界面。



- []：掛斷電話。
- []：打開或關閉麥克風。
- []：進入數字鍵盤界面。
- []：通話聲音將由本裝置的揚聲器轉換至手機。

※ 提示：

- ① 電話本顯示只有把電話本設定為同步后，才能有效顯示手機上的電話本號碼，電話本同步設定詳見“調整藍牙設定”描述。
- ② 輕觸 [] 圖標進入電話本搜索界面，可以通過英文和拼音進行快速查尋。

接聽電話

- 1、如有來電，屏幕上的 [來電 ...]，按 [接聽] 圖標即可接聽電話。
- 2、輕觸 [掛斷] 可終止通話。

調整藍牙設定

在本機藍牙菜單中，輕觸藍牙設定 [] 圖標，將顯示藍牙設定的選項菜單。



您可更改以下本機藍牙設定：

- [藍牙]：開啟或關閉“藍牙”功能。
- [自動連接]：開啟或關閉“自動連接”功能
- [自動應答]：開啟或關閉“自動應答”功能
- [配對密碼]：輸入默認密碼“1234”，您可以進入重新設定配對碼。重新設定配對碼完畢后，自動退出設定。
- [電話簿下載]：打開“同步”功能，可把手機中的“電話簿”同步到本機。輕觸“同步”即可同步手機上的電話號碼到本機中（同步過程大約需幾分鐘時間），同步完畢后，本機即可顯示手機電話本上的相關資訊。

手機音樂

- 如果所連接的手機支持高級音頻傳送功能 (A2DP)，則您可通過本機來播放存儲在手機中的音樂。
 - 1、將手機與本裝置配對。
 - 2、輕觸 [藍牙]，將顯示藍牙菜單。

藍牙

3. 手機播放音樂，音樂就從本機喇叭播出。
- 如果您的設備支持播放控制功能 (AVRCP)
 1. 輕觸本機藍牙界面上的 [🎵] 圖標，進入藍牙音樂操作界面。
 2. 可以通過本機藍牙界面功能圖標控制手機的音樂播放。
[⏮️]/[⏭️]: 上一曲 / 下一曲
[⏸️]: 暫停 / 播放

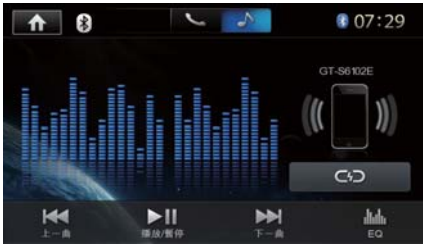

調整設定

※ 提示：輕觸主桌面的 []，進入設定界面。

通用設定

輕觸 [通用]，顯示以下選項，設定功能如下：

通用設定	選項	描述
收音區域		選擇一個與您所在區域相匹配的收音地區。
收音範圍		選擇一個與您所在區域相匹配的收音地區：遠程 / 本地。
黑屏模式	關閉	關閉黑屏模式。
	10 秒	10 秒后進入黑屏休眠模式，輕觸屏幕即喚醒。
	20 秒	20 秒后進入黑屏休眠模式，輕觸屏幕即喚醒。
調光器模式		輕觸本鍵，可以選擇四種不同光綫模式：夜晚 / 黃昏 / 正常 / 明亮。
蜂鳴器	關閉	操作聲音提示。
	開啟	
觸摸校準		輕觸 [確定]，開始進行校準，詳見提示①。
按鍵背光	紅色	可進入按鍵背光顏色選擇。
	綠色	
導航路徑設定		輕觸 [確定]，進入導航卡路徑設定界面。

屏幕校準設定

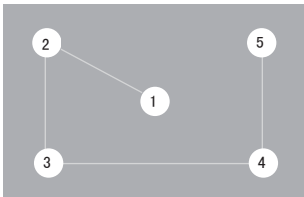

※ 提示：

①當您選擇觸摸校準的 [確認] 時，出現如左圖所示順序，用尖尖的鉛筆輕觸屏幕十字交叉點，系統完成屏幕核準后，自動返回。在校準觸摸屏的時候，請不要有其它任何操作，以免機器故障。

視頻設定

輕觸 [視頻]，顯示以下選項，設定功能如下：

視頻設定	選項	描述
行車時視頻	開啟	行駛時禁止觀看視屏，進入視屏觀看時會出現“警告”界面。
	關閉	行駛時可以觀看視屏。

調整設定

聲音設定

輕觸 [聲音]，顯示以下選項，設定功能如下：

聲音設定	選項	描述
重低音喇叭輸出	開啟	有重低音輸出。
	關閉	無重低音輸出。
重低音喇叭過濾	80Hz/120Hz/160Hz	選擇重低音揚聲器濾波器標準。
導航混音模式	背景音衰減 / 背景音正常 / 背景音靜音	選擇不同的聲音模式。

時間設定

具體設置詳見 P36。

語言設定

輕觸 [語言]，顯示以下選項，設定功能如下：

語言設定	選項	描述
OSD	操作界面語言	英文、繁體中文、俄文、西班牙文、泰文。
DVD 音頻語言	選擇 DVD 音頻語言	可用語言選擇取決於 DVD 光碟。
DVD 字幕	DVD 界面語言	英文、繁體中文、俄文、西班牙文、泰文。
碟片菜單	碟片菜單界面語言	英文、繁體中文、俄文、西班牙文、泰文。

藍牙設定

輕觸 [藍牙]，顯示以下選項，設定功能如下：

藍牙設定	選項	描述
藍牙	開啟 / 關閉	開啟 / 關閉。
自動連接	開啟 / 關閉	開啟 / 關閉。
自動回應	開啟 / 關閉	開啟 / 關閉。
配對碼	****	輸入配對密碼
麥克風設置	內置 / 外置	選擇麥克風設備

調整設定

碟片設定

輕觸 [碟片]，顯示以下選項，設定功能圖表如下：

DVD 設定	選項	描述
設定密碼	----	設定密碼以限制光碟的播放，默認密碼是 0000。
級別等級	Kid safe	適合兒童。
	G	適合普通觀眾。
	PG	建議家長指導觀看。
	PG-13	不適合 13 歲以下兒童。
	PG-R	建議家長限制 17 歲以下的青少年觀看。
	R	受限制，建議家長指導 17 歲以下的青少年觀看。
	NC-17	不適合 17 歲以下的青少年觀看。
Adult	僅適合由成年人觀看。	
動態範圍壓縮	開啟 / 關閉	
恢復出廠設置	復位，選擇是否執行。	

音量設定

您可針對不同的音源設定不同的音量增益，以使各個音源的音量輸出差異符合您的習慣。

1、輕觸 [音量]，顯示音源音量增益設定界面。

2、選擇相應音源，輕觸 [▲] 或 [▼] 調節音量範圍 :0 至 12。

其它

外接輸入設備使用：

1. 如果原車有外接輸入設備的音頻接口，使用主機【Ori AUX-IN】功能，能夠收聽外置設備的音頻。
2. 使用主機的【AV-IN】功能，能夠收聽和觀看外置設備的音視頻。
3. 輕觸屏幕左上角退出，切換至其它播放源即可停止當前 AV 輸入的播放。

※ 提示：如果您通過 AUX IN L/R 連接線（請參閱連線圖）將本系統連接至其它音頻設備，然後輕觸 [Ori AUX IN]/[AV-IN] 可聆聽該設備中的音樂。

TV (選配設備)

本機可支持 TV 數字電視功能，TV 盒子需要另外購買，詳細操控描述另見數字電視說明書。

系統初始化

本裝置出現不當操作引起的死機等，或出現非正常工作現象時，使用圓珠筆或類似工具按復位鍵，本機便可恢復正常工作。

復位鍵

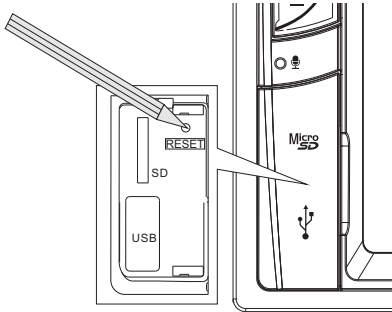

更換保險絲

如果不能通電，則保險絲可能已熔斷，需要更換。

1. 取出本機。
2. 請檢查電路連接。
3. 購買與熔斷保險絲（15A）電流相符的保險絲。
4. 更換保險絲。

導航功能

1. 進入通用設置中，正確選擇導航路徑。
2. 進入主桌面。
3. 輕觸【導航】，進入導航系統。

其它

方向盤控制

※ 提示：本產品在出廠前已按原車方向盤功能預設好，但由於車型本身差異，請使用下述方法來設定方向盤功能。

- 1、輕觸主桌面上的 [方控設定] 圖標，進入方向盤控制操作界面，如下圖所示：



- 2、輕觸 [重設] 圖標，本機將方向盤控制默認的設定複位並清除，界面上方顯示“重設成功！請等待屏幕提示后繼續學習！”。重設完成后，操作界面更新，顯示如下圖所示，此時您按提示完成操作。



例如：按提示選擇了屏幕方控操作界面的 [聲音+]，界面顯示如下圖所示；



然後輕觸原車方向盤上的 [聲音+] 鍵，此時界面顯示如下圖所示；



最後輕觸界面上的 [保存] 圖標，即可完成“聲音+”功能鍵的設定，屏幕將顯示“保存成功”；如下圖所示。



※ 提示：

- ① 根據屏幕的提示，可將原車的方控鍵一次設定完畢，操作同 [聲音+] 鍵設定。
- ② 您可依所需任意設定方向盤按鍵功能鍵，如選擇原車的 [靜音] 鍵，再輕觸屏幕的 [聲音+]，即可將該原車 [靜音] 鍵設為 [聲音+]。

設備連接

注意事項

- 本機用於 12V 電池和負極接地的車輛，若將本機安裝在 24V 電池系統的車輛，請安裝降壓裝置。
- 為了避免電氣系統短路，安裝前應斷開電池的負極端的連接。
- 請將連線佈置在可固定的地方，使其無法接觸任何移動部件，如手剎、變速桿、座椅固定導軌等；不要將連線佈置在熱源區，如暖氣排出口附近等，否則熱源會引起接線的絕緣層熔化或磨損，進而引起連接線與車身短路。
- 請勿將電源正極連接線穿過安裝孔引入引擎室再接電池，否則可能損壞電源線，進而引起電源線與車身短路。
- 更換保險絲時，請使用指定規格（15A）的保險絲，使用規格不匹配的保險絲可能導致無法正常工作，甚至損壞本機或引發火災。
- 請勿將其他設備與本機共用一個電源，否則可能因過載導致故障。
- 請用絕緣膠布包裹連接線裸露處，以免發生短路現象。
- 捆扎好所有連接線，避免任何連線端子與機身或車身金屬部分接觸而導致短路。
- 當打開本機電源時，外接功放控制信號通過連接線 P.CONT 輸出，若本機連接了外接功放，請不要將 P.CONT 連接至功放的電源端，否則會引發故障。
- 本機的揚聲器輸出端子嚴禁接地，否則將會燒壞功放。請勿使用共接地線的 3 線型揚聲器系統，不可將揚聲器連接線接在車體上。
- 連接本機的揚聲器的最大額定功率為 45W，阻抗值為 4 Ω 。

安裝向導

1. 如已安裝其它車載音響設備，請先拆除。
2. 按上頁內容進行電氣連接：
 - 如有必要，將行車禁止播放線連接到手剎裝置，這樣做可以在車輛停靠時欣賞影片。
 - 如有必要，將倒車后視線連接到倒車燈，這樣可以在倒車時通過本機顯示屏觀察車后情況。
3. 在安裝主機前檢查電氣連接是否正確。
4. 拆掉主機頂部的兩顆螺絲，否則本機不能正常使用。
5. 使用標配的螺絲將主機固定在儀表板內。
安全起見，請專業技術人員進行安裝。

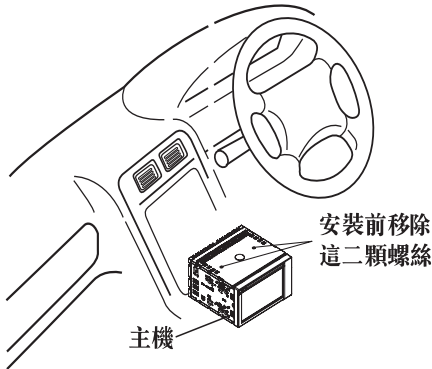

兼容的 USB 設備

- USB(USB 1.1/2.0)
- USB 播放機 (USB 1.1/2.0)
- 存儲卡 (Micro SD/TF)

支持的格式：

- USB 或內存文件格式：FAT32
- MP3 位速率 (數據速率)；
32-320Kbps 和可變位速率
- 目錄嵌套最多可達 8 層
- 專輯 / 文件夾數量：最多 99
- 曲目 / 標題數量：最多 999
- ID3 標籤 v2.0 或更高的版本
- Unicode UTF8 類型的文件名 (最大長度：
128 個字節)

不支持的格式：

- 空專輯：空專輯是指不包含 MP3 文件的專輯，將不會在屏幕上顯示。
- 將跳過不支持的文件格式。
例如，Word 文檔 (.doc) 或擴展名為 .dlf 的 MP3 文件將被忽略，不會播放。

支持的 MP3 光碟格式：

- ISO 9660, Joliet
- 最大標題數：512(視文件名長度而定)
- 最大專輯數：255
- 支持的採樣頻率：32 kHz、44.1kHz、48kHz
- 支持的比特率：32 -320kbps 和可變位速率。

產品信息

常規	
操作電壓	10.5 ~ 16V DC。
最大電流	max. 15A
最大的功率輸出	50W x 4 channels (max)
支持的多媒體	DVD/VCD/CD/MP3/MP4/JPEG/CD-R/CD-RW/DVD+R/ DVD+RW PLAYBACK/RMVB
安裝尺寸 (長 x 寬 x 高) / 重量	169X178X101.5mm/1.82kg
溫度 (安裝)	-20°C - +60°C
電子抗震功能	35 sec.for Audio CD, 120 sec. for MP3
TFT 顯示屏	
顯示屏尺寸	6.8 inch
分辨率	800*480 pixel
縱橫比:	4:3 /16:9
背光度	400 cd/m
對比度	500 : 1
FM 立體收音	
頻率範圍 (歐洲地區)	87.5-108MHz(Step 50KHz)
頻率範圍 (俄羅斯地區)	87.5-108MHz(Step 50KHz)、65-74MHz(Step 30KHz)
頻率範圍 (澳洲)	87.5-108MHz(Step 100KHz)
頻率範圍 (中東)	87.5-108MHz(Step 50KHz)
頻率範圍 (美國)	87.5-107.9MHz(Step 200KHz)
頻率範圍 (拉丁美洲)	87.5-108MHz(Step 100KHz)
頻率範圍 (亞洲)	87.5-108MHz(Step 50KHz)
頻率範圍 (日本)	76-90MHz(Step 100KHz)
預存臺	18
AM 收音	
頻率範圍 (歐洲地區)	522kHz-1620KHz(Step 9KHz)
頻率範圍 (俄羅斯地區)	522kHz-1620KHz(Step 9KHz)
頻率範圍 (澳洲)	522kHz-1710KHz(Step 9KHz)
頻率範圍 (中東)	522kHz-1620KHz(Step 9KHz)
頻率範圍 (美國)	530kHz-1710KHz(Step 10KHz)
頻率範圍 (拉丁美洲)	530kHz-1710KHz(Step 10KHz)
頻率範圍 (亞洲)	522kHz-1620KHz(Step 9KHz)
頻率範圍 (日本)	522kHz-1629KHz(Step 9KHz)
預存臺	12

故障排除

問題	原因	方法
一般問題		
無法打開本機電源	本機保險絲已燒熔。	安裝合適規格的新保險絲。
	汽車電池保險絲已燒熔。	安裝合適規格的新保險絲。
無法打開本機電源 按下按鈕時無任何反應。 顯示內容不正確。	違規操作。	關閉電源，用一根細棒按復位孔。 * 按下復位按鈕時，硬件復位后存的電臺及相關移動設備均有記憶。
無 / 低音頻輸出	音頻輸出連接不正確。	檢查連線並改正。
	音量過低。	調高音量。
	揚聲器損壞。	更換揚聲器。
	聲音音量嚴重不平衡。	將聲道平衡調到中間位置。
	揚聲器接 接觸到汽車的金屬部件。	將所有揚聲器接線連接絕緣。
音質差或失真	使用了非標準光碟。	使用標準光碟。
	揚聲器功率與本機不匹配。	更換揚聲器。
	連接錯誤。	檢查連線並改正。
	揚聲器短路。	檢查連線並改正。
發動機關閉時，本機會復位	ACC 與電池之間的連接錯誤。	檢查連線並改正。
CD/VCD/DVD 播放機		
無法裝入光碟。	已裝入其它光碟。	退出光碟，再裝入新光碟。
	碟片槽中有異物。	務必取出異物。
聲音跳躍或嘈雜。	光碟髒污。	用軟布清潔光碟。
	光碟嚴重刮傷或變形。	用無刮傷的光碟更換。
剛打開電源時，音質很差。	當汽車停泊在潮濕場所時，內部透鏡上會凝結水珠。	打開電源，等待 1 小時讓其晾乾。
隨身碟 /SD 設備		
無法插入隨身碟 /SD 設備。	隨身碟 /SD 設備的插入方向錯誤。	反轉隨身碟 /SD 設備的連接方向，然後重試。
	隨身碟 /SD 接頭破損。	換一臺新的隨身碟 /SD 設備。
無法識別隨身碟 /SD 設備。	隨身碟 /SD 設備損壞。	斷開隨身碟 /SD 設備的連接，然後重新連接。
	接頭松脫。	如果仍無法識別設備，換一個隨身碟 /SD 設備。
播放文件不識別 / 播放質量差。	文件類別或編碼信息與機器系統不兼容。	建議使用同本機兼容的視頻格式轉換軟體進行有效格式的轉換。
藍牙		
無法將已啟用藍牙的設備與本機系統配對。	該設備不支持系統所需的協議。	使用另一臺設備進行連接。
	該設備的藍牙功能未啟用。	關於如何啟用藍牙功能，請參閱該設備的使用說明書。
儘管藍牙連接成功，仍不能在系統上播放音樂。	手機不支持 A2DP 功能	另外保存能支持播放格式的文件到手機中
連接支持藍牙的設備后，音質變差。	接收品質較差。	將設備移近本系統，或移除設備和系統之間的任何障礙物，調節好信號。

電氣連接圖

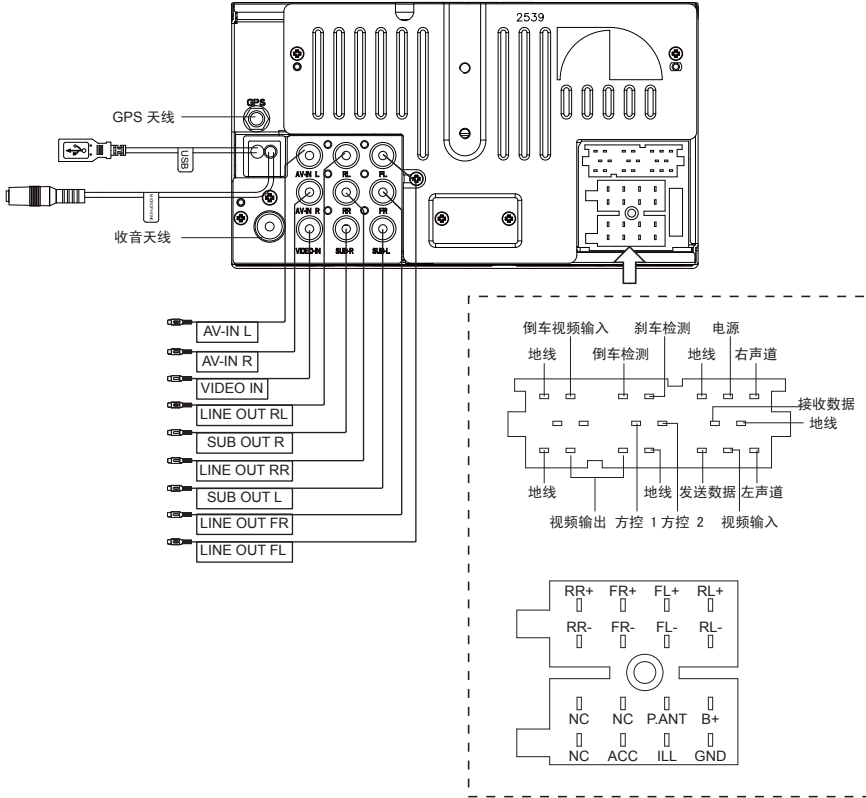

快速安裝指引

1 包裝盒物品

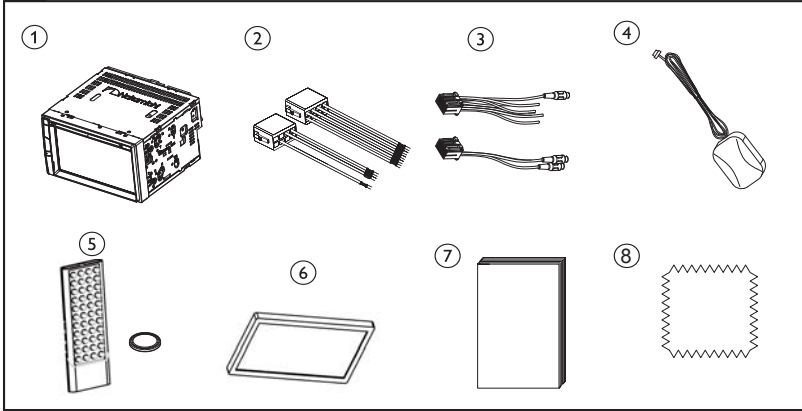

相關物件:

- | | | |
|--------------|----------|--------|
| 1 主機 | 4 GPS 天線 | 7 用戶手冊 |
| 2 ISO 連接線 x2 | 5 遙控器和電池 | 8 清潔布 |
| 3 視頻纜束 | 6 裝飾框 | |

2 4.1 音頻連接

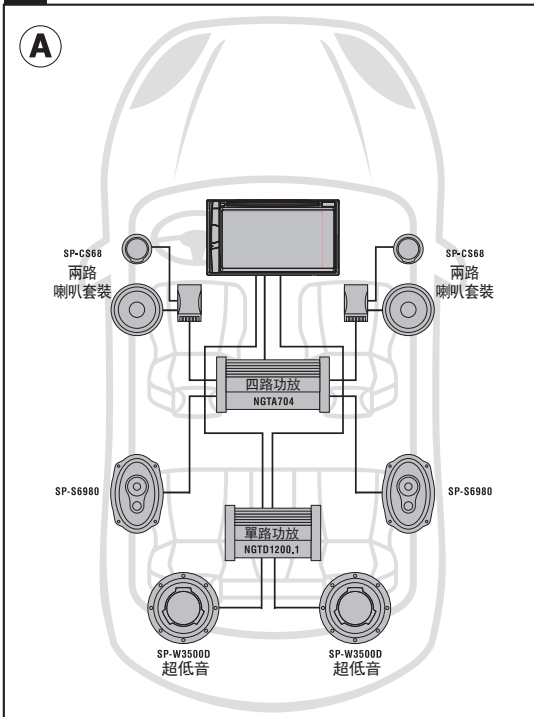

快速安裝指引

3 連接系統

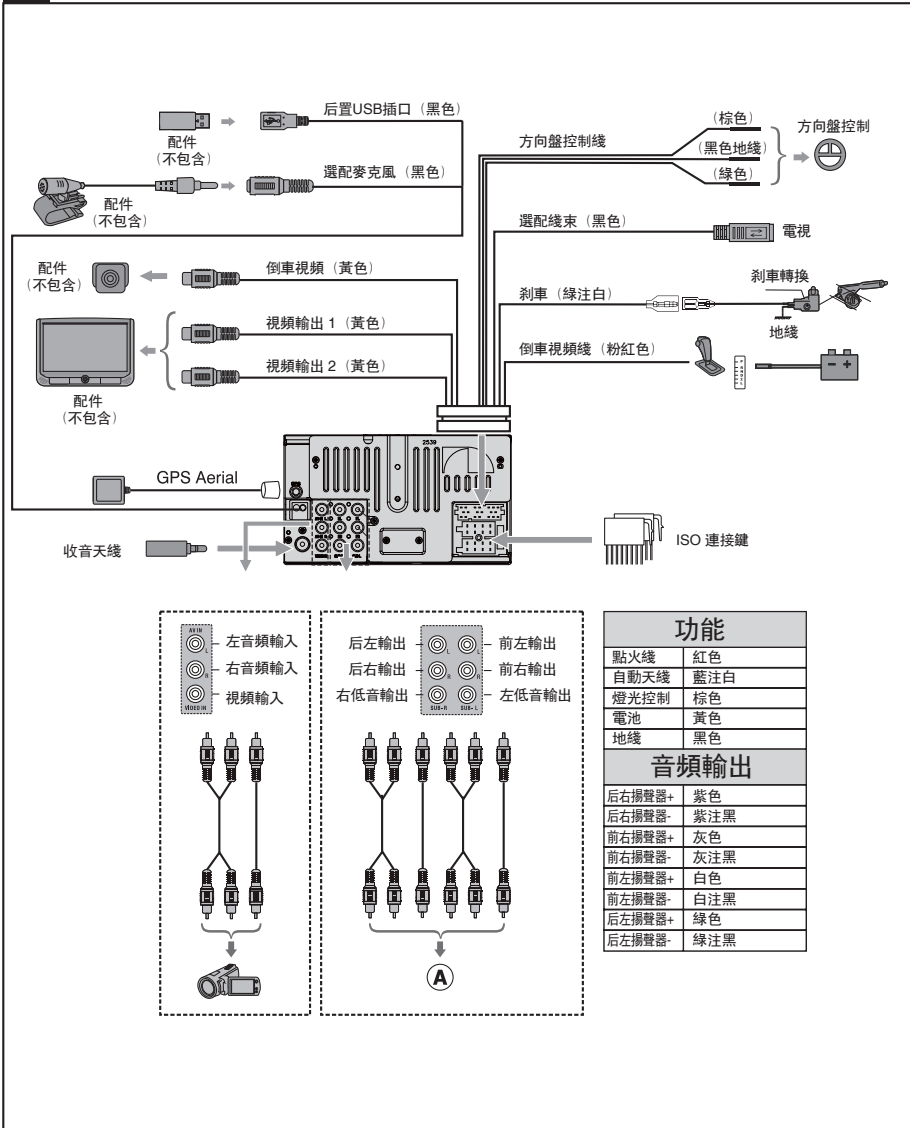

快速安裝指引

4 儀表盤上安裝

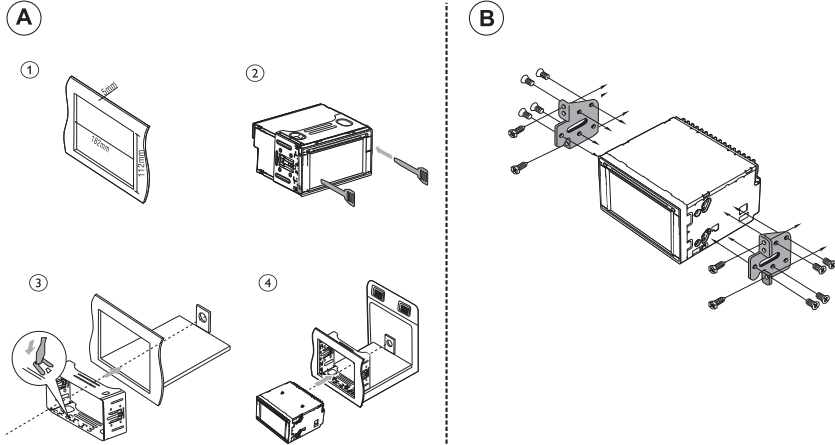

⚠ 所有安裝的螺釘和螺母都沒有包含在此包裝中。

5 麥克風

1. 麥克風插槽

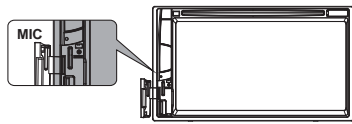

2. 選配麥克風

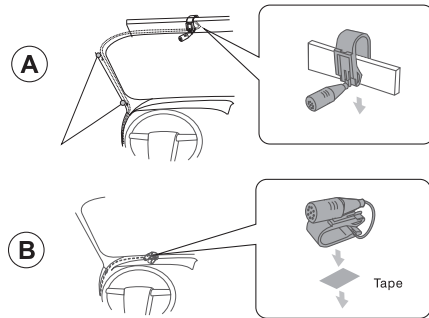

⚠ 本品不提供選配麥克風。

快速安裝指引

6 內存卡播放設備

插入一張內存卡

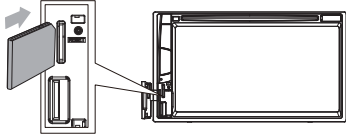

7 為手機充電

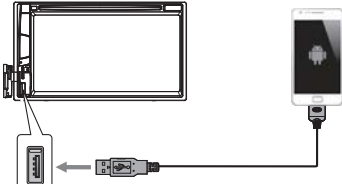

⚠ 充電時不可轉換為USB模式。
本品不包含連接線。

8 鏈接GPS

插入GPS地圖卡

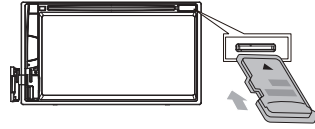

⚠ 請在插入GPS地圖卡之前關閉電源。

安裝GPS天線

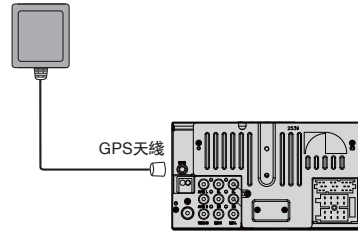

⚠ 本品包含天線。

在車輛內部安裝GPS天線

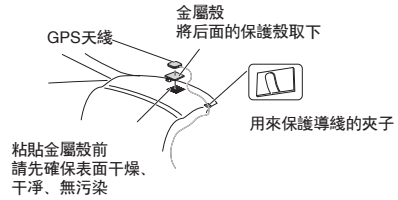

⚠ 取下金屬殼可能會在表面留下粘劑的痕迹。

快速安裝指引

9 方控

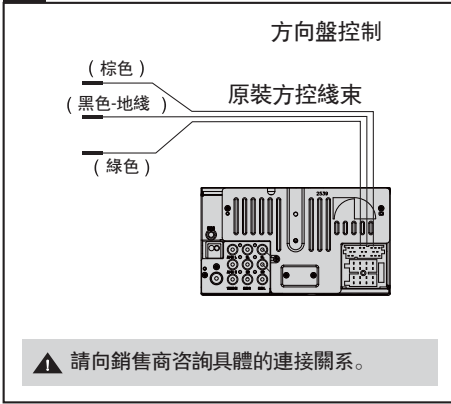

10 選配設備連接

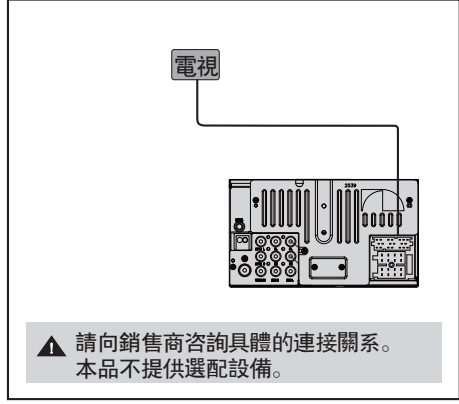

11 重置系統

如果系統死機，可重置。

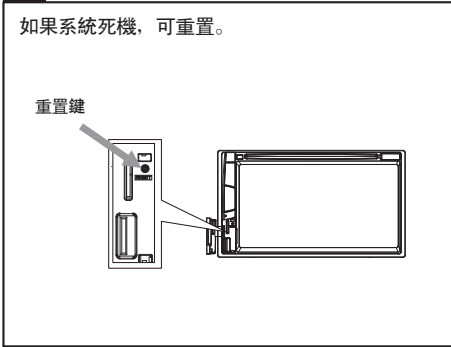



Design and specifications are subject to change
without notice

© 2014 Nakamichi
www.nakamichicaraudio.com

